

**S U S T**

**S**udan **U**niversity of **S**cience and **T**echnology

**F**aculty of **A**rchitecture and **P**lanning

**F** i f t h **Y** e a r **B** a c h e l o r

**G** r a d u a t i o n **F** i n a l **R** e p o r t

**K**hartoum **C**omplex of **S**cience and **T**echnology

**P**repared by | **M**ohamed**E**lmubarak **W**ail **O**sman

**S**upervised by | **T. Tahani A'shmaig**

**S** e p 2 0 1 8



بِسْمِ اللّٰهِ الرَّحْمٰنِ الرَّحِیْمِ

(اقراء بسم ربك الذي خلق \* خلق الإنسان من علق \* اقرأ وربك الأكرم \* الذي علم بالقلم \* علم الإنسان ما لا يعلم)

سورة العلق الآية 1 - 5

## Contents

<b>Thank you.....</b>	<b>6</b>
<b>Dedication... ..</b>	<b>7</b>
<b>Report Brief.....</b>	<b>8</b>
<b>Chapter One .....</b>	<b>9</b>
1-1   Introduction .....	10
1-2   Project Definition .....	11
The Purpose behind the project .....	11
Aiming.....	11
The size of the Project Boundaries .....	12
Project challenges.....	12
The funders of the project will be mainly.....	12
<b>Chapter Two.....</b>	<b>13</b>
2-1   what is technology...? .....	14
2-2   Similar Examples .....	14
2-2-2   Science City – Syria.....	15
2-2-3   The City of Art and Science - Spain.....	20
<b>Chapter Three.....</b>	<b>24</b>
3-1   Project Components Diagrams .....	25
3-1-1   Activity Components Diagrams .....	26
3-1-2   Human Components Diagram .....	28
3-1-3   Space Components Diagram .....	28
3-2   Architectural Function Diagrams .....	30
3-3   Area Calculation Tables.....	34
- Total Sectors Area .....	37
- Area Percentage Diagram .....	38

3-4   Users Circulation Diagrams .....	39
3-5   Proposed Location Overview .....	42
❓ Comparison Table.....	43
3-6   Site Environmental Analysis .....	44
3-7   Design Guide Lines .....	47
3-8   Design Zoning.....	48
<b>Chapter Four</b> .....	49
Project Design .....	50
4-1   Complex Design Concept .....	50
4-2   Library Building Design.....	57
4-2-1   Library Concept Diagrams .....	57
4-2-2   Library Concept Sketches .....	58
4-2-3   Library Design .....	59
4-3   Conference Center Building Design .....	61
4-3-1   Conference Center Concept Sketches.....	61
4-3   Conference Center Building Design .....	63
4-4   Research Labs & Astrodome Design .....	65
<b>Chapter Five</b> .....	67
5-1   Structural System .....	68
5-1-1   the structural foundations .....	68
5-1-2   Structural columns .....	69
5-1-3   Structural Floors .....	69
5-1-4   Roof Structure .....	70
5-1-5 Expansion joints .....	70
5-1-6   3D structure Model .....	71
5-2   Finishing Solutions .....	71
5-3   Site Electrical Supply .....	74

5-4   Water supply .....	76
5-5   Sewage and Drainage System .....	80
Drainage Systems .....	80
Sewage System .....	81
5-6   Air Condition System.....	85
5-7   Fire Fighting System.....	88
5-8   Vertical Circulation System .....	90
<b>References</b> .....	92

## Thank you...

Allah lord of all lands and heavens creator of the universe and all the existing - that nothing existed before him - thank you for the gift of life, the gift of knowing you, the gift of being a Muslim that worship you.

Thank you for helping me on my way of learning and study, for aiding me in my needs, for all the knowledge you gave me and for the one, which you will in the rest of my life. You are the first before anyone, and the last that no one comes after. Thank you for giving me the strength to complete this thesis of graduation.

## A word of thanks...

To all who gave me the ambition to keep on my study.

To all who gave me the credit of doing something.

To all who build the confident I have now from my family, teachers, colleagues and friends.

You are all a family of mine.

## Dedication...

My father the one I saw as an idol.

My mother the one you kept praying and asking Allah for my safety and success.

My family who helped me through all the hard times.

My teachers those who gave me knowledge even if it was little.

My encouraging Supervisor T. Tahani A'shmaig

My batch who considered me as there help at any time and gave me the feeling of being a person that is liked by people.

To those individuals who helped me through my journey from the moment it started

Yasmine Alsagdey, Anwar Abd Alaal, Husam Awad, Husam Rahim, Abd Alrahman Siddig, Ahmed Salah, Hind Kareem, Alaa Hassan, Rawan Rabie, Ohoud Adil, Samar Khairy, Badr Aldeen, Mazin Satti, Ahmed Makki, Huzaiifa Mubarak, and many others.

To my friends and those I enjoy your company.

Finally yet importantly, to you who kept me positive, joyful and gave me what I cannot express.

Thank you all for the good times you gave me and I really appreciate what you did to me, you are all a family of mine.

## Report Brief

This paper contains five chapters that begin with an introduction to the project, throughout data collection and analysis to finally the design the indicators, which the design is built over it, and developed until the final phase. It will also include all the construction and technical solutions of the project, and explanations by drawings schemes and schedules as much as possible.

The paper begins with explaining the type of the project (Khartoum complex of science and technology - KCST), and what is science and technology. Also studying and analyzing examples of similar projects, and collecting all the necessary data related to the topic and then analyzing it also, and define the activities and the human components, which leads to the spaces and functional components of the project, and briefing the areas of the spaces in schedules in order to achieve the proper total area.

After the above mentioned comes the process of choosing a site; and that depends on certain basis, after that all the parameters and the environment must be analyzed, and then all the indicators and configurations can be briefed. By that, all the necessary data have been included.

Then comes the proposed zoning diagram, which present an initial idea about the spaces that the project will include. Comes after it the concept and the philosophy of the design until the final design stage.

Finally, the explanation of the technical and structure solutions will be discussed.



# Khartoum Complex of Science and Technology

K C S T

## Chapter One

### *Introduction to KCST*



## 1-1 | Introduction

**S**udan is considered one of the poor developing countries in Africa that was to be due the civil war in the country, which held the country from developing knowing that it is well known for its rich resources. Beside that for the past 20 years when the world was facing the future of using many different technologies in many fields and walking towards a life that depends on these high technologies, Sudan was left behind for the past mentioned reasons.

Therefore, to catch up with the world here comes the role of **KCST** as a community that helps the country to enter the future of using technology.

**KCST** Khartoum Complex of Science and Technology is a compound that contains multiple buildings, which are functioned to serve students of higher education and scientists on tech fields for multiple specialties.

The complex contains four main sectors, library for students and researchers, and a conference center for any scientific conventions, an astronomic dome plus high tech galleries and exhibitions, and research labs for both students, researches and scientists.

The main objective of the project is to provide an environment for the researches and students of electronic engineering, Computer Science and I.T. studies...etc. to practice their activities in an appropriate way to rebuild and develop what universities failed at through the past Quarter of a century. Moreover, to be updated for what is happening outside the world and to produce and develop a technology that can be stamped with made in Sudan.

## 1-2 | *Project Definition*

The Complex is a combination of multiple buildings that provide all the necessary components and spaces, which serve any activity, refers to education, research and anything goes under the term of science and technology.

The Complex is going to represent the Science & TECH revolution in Sudan by becoming the main hub of these activities.

### **The Purpose behind the project**

For the past decade, technology has ruled a great part in the process of education, which is by making the process of learning more fun, using visualizing technologies and what is similar. This resulted the students to be more into learning new things. By other meaning in order to keep the education an easy process for each individual, technology must take a role at some point.

Sudan suffers from the lack of the proper science research facilities, exhibitions and any institution that participate in these fields although it has many potentials

The Project here came to satisfy this need by providing the necessary facilities that can accommodate the fields that goes under the term of science and technology and also to develop and raise the level of education and science in this country.

The project has a major importance for what activities that it adopts, which reflects on the development of science research and education.

The need to develop the way of study and research and improve the understanding of technology in the country.

### **Aiming**

**Scientific** There is no better way to show the advancing of scientific researches than the visual way, and that will be by equipping the complex with the most developed high tech, and designing it to adapt to any new technologies, which are invented at the complex or any scientific institutions in the country. By other meaning the complex itself will experience continuous changing in the visual environment that the user experience.

**Architectural** The rise of any country and its development are reflected on its architecture. This project will be the main hub of this development, by creating this complex in a way that represent the future of this country, creating a futuristic architectural style. That can change

the traditional non-modern concepts that the country fell behind many years when the whole world was exceeding the boundaries of the human imagination.

### **The size of the Project Boundaries**

The project is considered to be national and serve the state of Khartoum and its regions as a central complex for all the scientific activities that are done in any institution in all of city and will be cooperating with any foreign institutes and tech companies.

### **Project challenges**

Creating a multiple buildings with an extraordinary futuristic style that reflect the high tech architecture, and can obtain all the proposed activities, and is able to be expanded in the future.

Installing and fixing all the equipment and linking it with building making it by that an Integrated high tech building.

Linking all the complex components and activities in a way that does not interfere with the workflow of the activities and the user Comfort.

The surrounding environment challenges, both the nature and the infrastructure of the area.

### **The funders of the project will be mainly**

1. National center for research and studies
2. High education ministry
3. Private sectors and companies

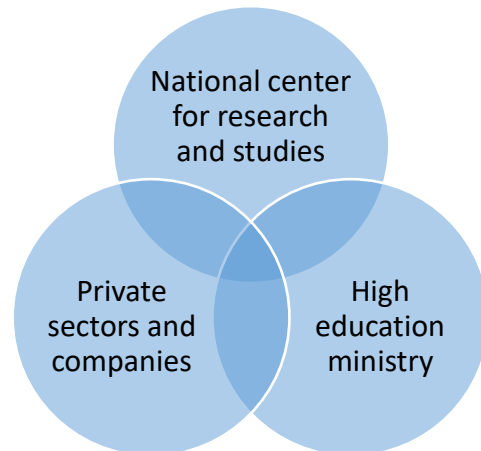

# Khartoum **C**omplex of **S**cience and **T**echnology

**K C S T**

## Chapter Two

### *Data Collection*



## 2-1 | *what is technology...?*

**Technology** ("science of craft", from Greek Ancient Language) is first robustly defined by Jacob Bigelow in 1829 as: "...principles, processes, and nomenclatures of the more conspicuous arts, particularly those which involve applications of science, and which may be considered useful, by promoting the benefit of society, together with the emolument [compensation] of those who pursue them".

The simplest form of technology is the development and use of basic tools.

The prehistoric discovery of how to control fire and the later Neolithic Revolution increased the available sources of food, and the invention of the wheel helped humans to travel in and control their environment. Developments in historic times, including the printing press, the telephone, and the Internet, have lessened physical barriers to communication and allowed humans to interact freely on a global scale.

Technology can be viewed as an activity that forms or changes culture. Additionally, technology is the application of math, science, and the arts for the benefit of life, as it is known. A modern example is the rise of communication technology, which has lessened barriers to human interaction and as a result has helped spawn new subcultures; the rise of cyber culture has at its basis the development of the Internet and the computer.<sup>1</sup> Not all technology enhances culture in a creative way; technology can also help facilitate political oppression and war via tools such as guns. As a cultural activity, technology predates both science and engineering, each of which formalize some aspects of technological endeavor.

### **Science and Technology**

The distinction between science and technology is not always clear. Science is systematic knowledge of the physical or material world gained through observation and experimentation. Technologies are not usually exclusively products of science, because they have to satisfy requirements such as utility, usability, and safety.

## 2-2 | *Similar Examples*

- **Science City – Syria.**
- **The City of Art and Science – Spain.**

## 2-2-2 | Science City – Syria

- Location Syria – Damascus.
- Total area 60,000b m<sup>2</sup>.

The city is a set of combined buildings that are connected with each other and are inspired from Damascus flower.

The components of the city are investment office, auditoriums and science exhibitions. The administration of the facility is attached to each individual building, and not combined in one single volume.

The project is previewed through these figures.



Figure 1

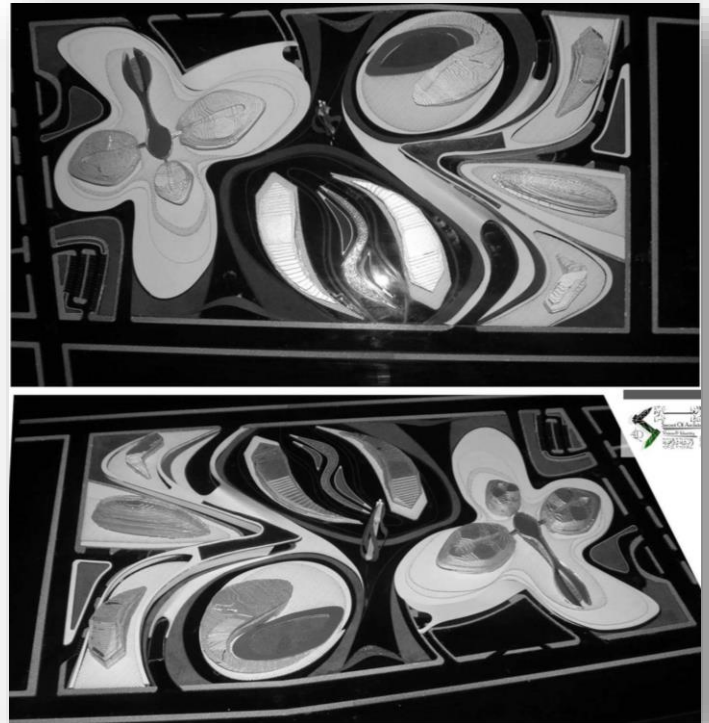
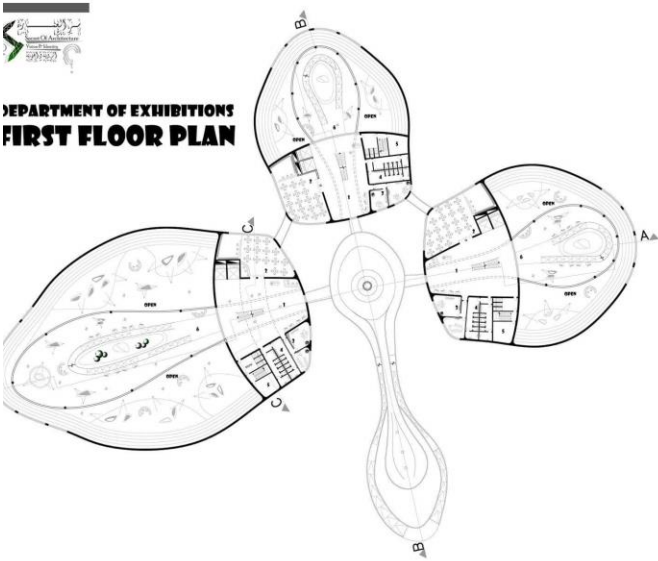

Figure 3



Figure 2



The Figures here shows the volume of the exhibition and galleries from plans, section to elevation

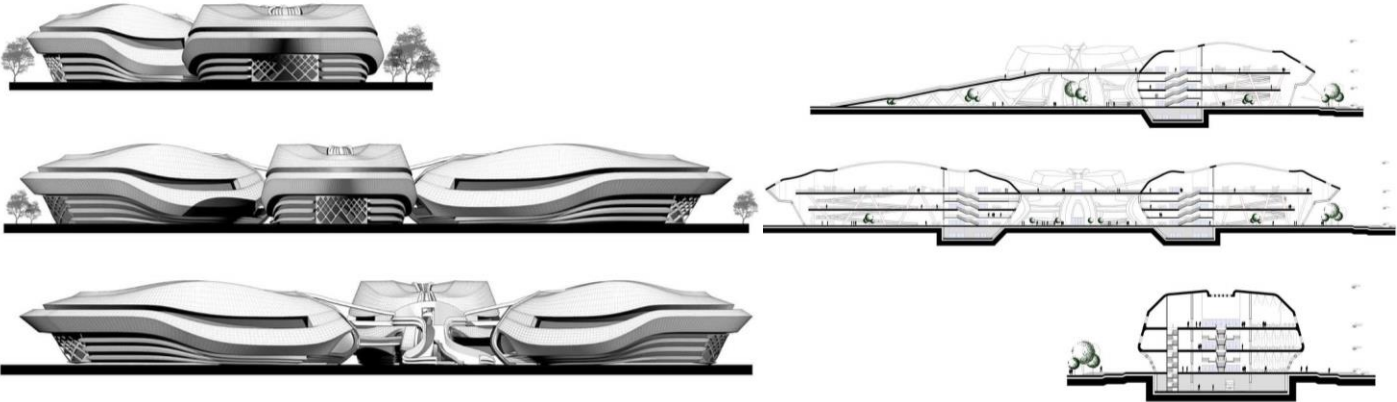



**AUDITORIUM  
SITE PLAN**

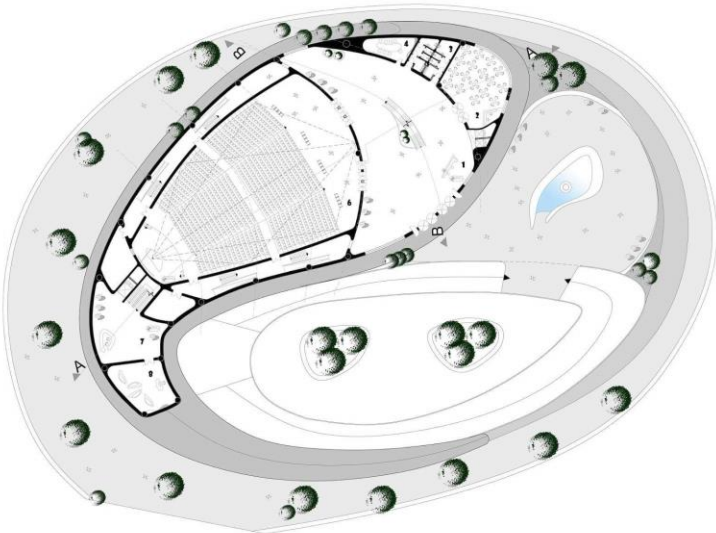

**AUDITORIUM  
SECTION**

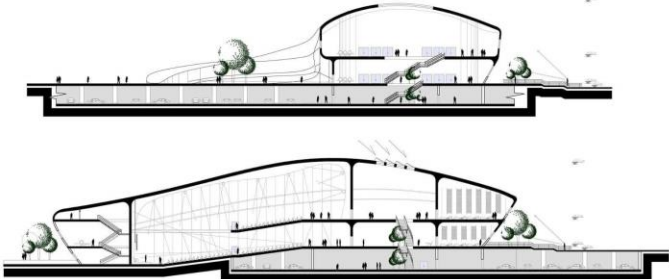

The figures here shows the volume of the conference hall building from its plans, sections to elevations

**AUDITORIUM  
ELEVATION**

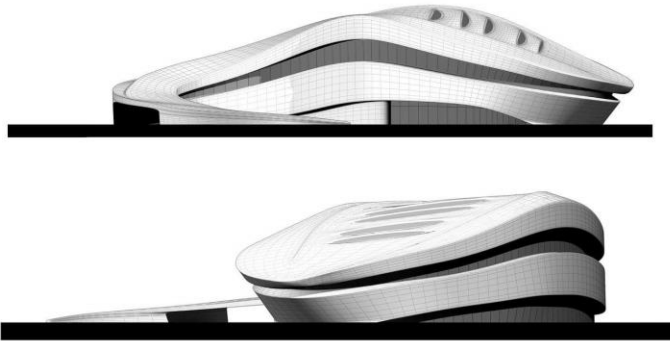

**AUDITORIUM  
ANALYSIS OF MASS**

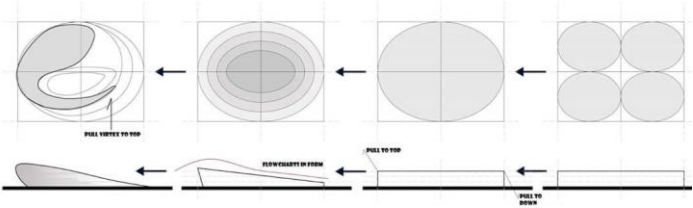

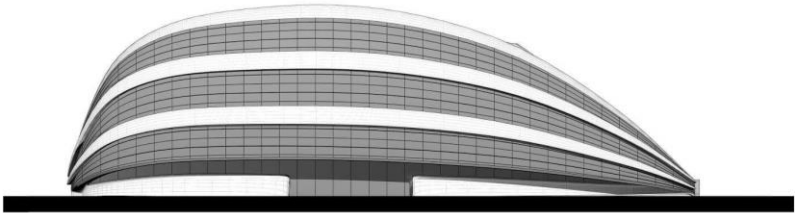
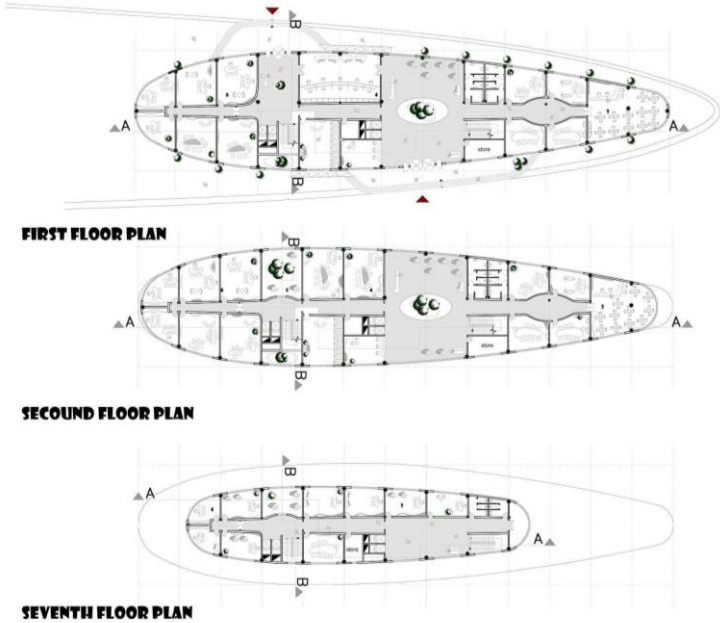
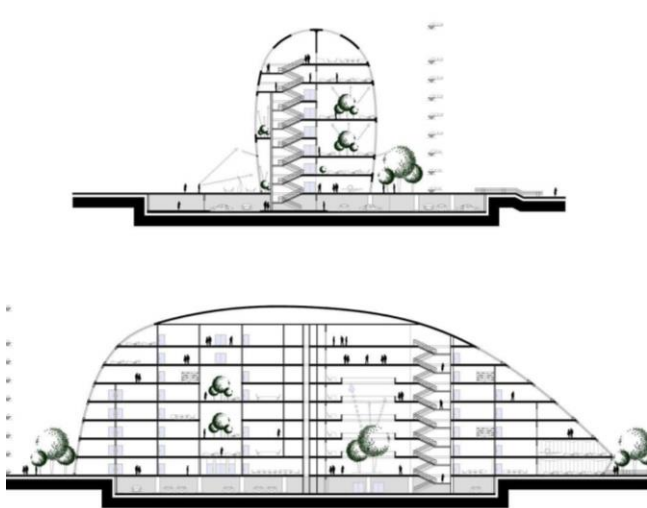

The figures here show the volume of the investment office and research labs from plan, sections and elevations.



## Positive design points

- The activities are distributed equally on the area of the property.
- The design is inspired from the local culture.
- The functional bonding between the building and volumes has enhanced the circulation between them.
- The design of the volume reflect the nature of the function with is futuristic concepts.

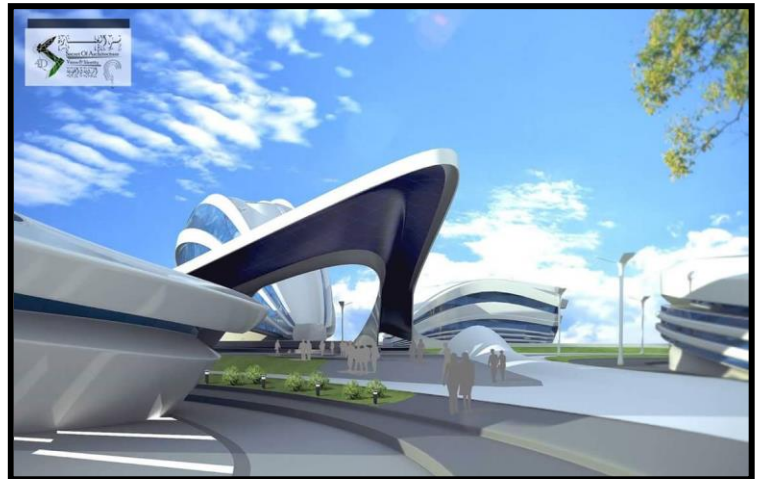

## Negative design points

- Too many entrances to the property of the site, which result in under controlling and security.
- The parking are not distributed well at the property.
- The ratio between the number of volumes and the property's area is not suitable; there are too many volumes for this small area.

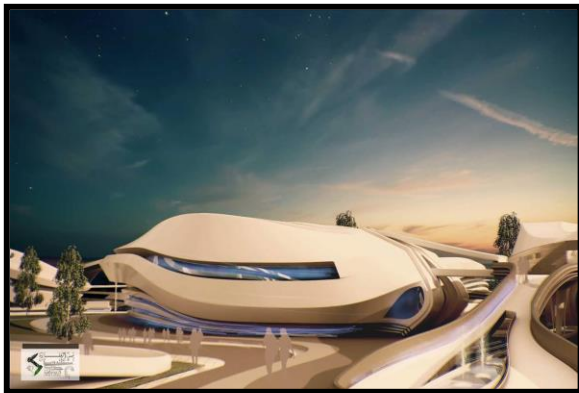

### 2-2-3 | The City of Art and Science - Spain

The City of Science and Art is an entertainment-based cultural and architectural complex in the city of Valencia, Spain. It is the most important modern tourist destination in the city of Valencia and one of the 12 Treasures of Spain.

The project began the first stages of construction in July 1996, and was inaugurated April 16, 1998 with the opening of L'Hemisfèric. The last great component of the City of Arts and Sciences, El Palau de les Arts Reina Sofia, was inaugurated on October 9, 2005, Valencian Community Day.

The City of Art and Science Valencia Spain

It is a big complex of five different building that is divided into three main categories Art, Science and Nature.

The Advantages Are perfect interlinking between activities and Attractive set of buildings to tourists and a good distribution of the entrances

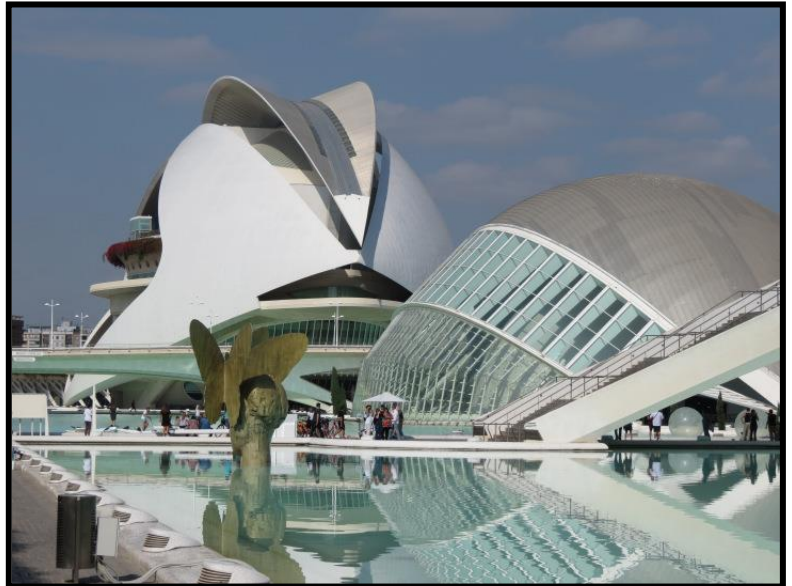



## The City is divided into 7 sectors

- Astronomic Dome
- Prince Philip Science Museum
- Umbracle
- Oceanographic
- The agora
- Queen Sofia Palace of Arts
- The Bridge of the Assut of the Or

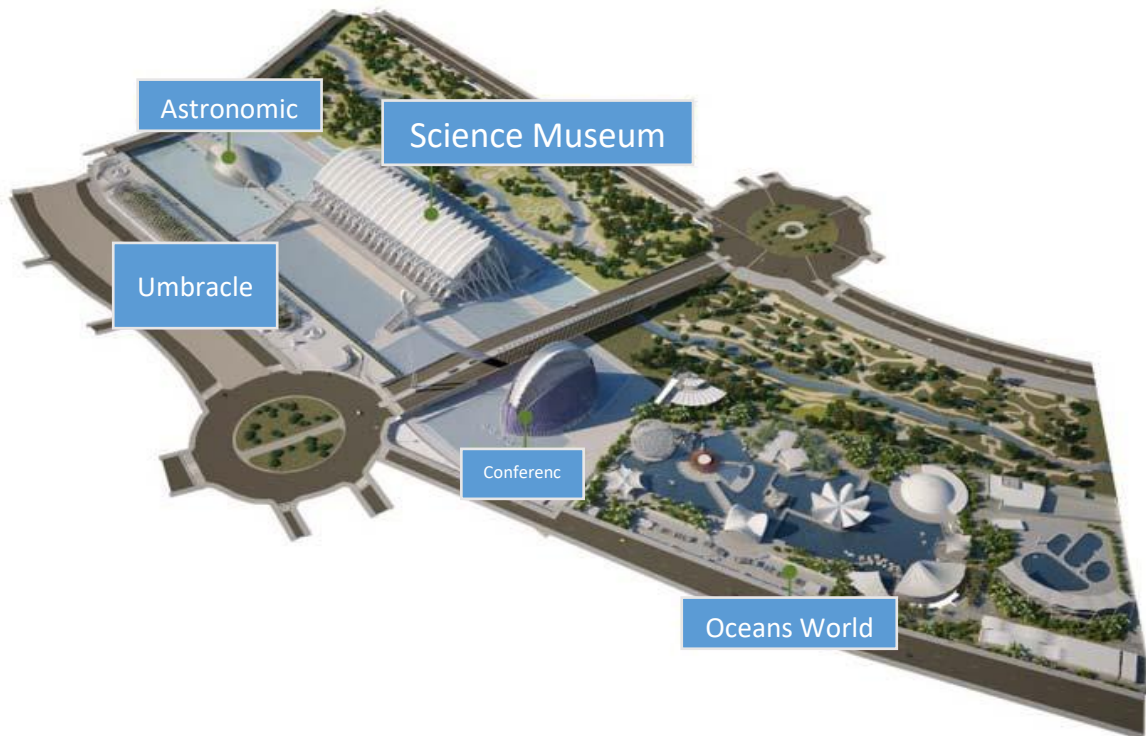

**L'Hemisfèric** an IMAX Cinema, planetarium and laserium. The building is meant to resemble a giant eye, and has an approximate surface of 13,000 m<sup>2</sup>. This planetarium is a half-sphere composed of concrete 110 meters long and 55.5 meters wide.



**El Museu de les Ciències Príncipe Felipe** is an interactive museum of science that resembles the skeleton of a whale. It occupies around 40,000 m<sup>2</sup> on three floors.

The building is made up of three floors of which 26,000 square meters is used for exhibitions.

The **Umbracle** is also home to numerous freestanding sculptures surrounded by nature. It was designed as an

entrance to the City of Arts and Sciences. It is 320 meters long and 60 meters wide.



**L'Oceanogràfic**

**L'Oceanogràfic** an open-air oceanographic park, designed by Félix Candela. It is the largest oceanographic aquarium in Europe with 110,000 square meters and 42 million liters of water.

The **Agora** is a space designed to hold a variety of events such as concerts, performances, exhibitions, conventions, staging of congresses, and international sports meetings.



**Agora**

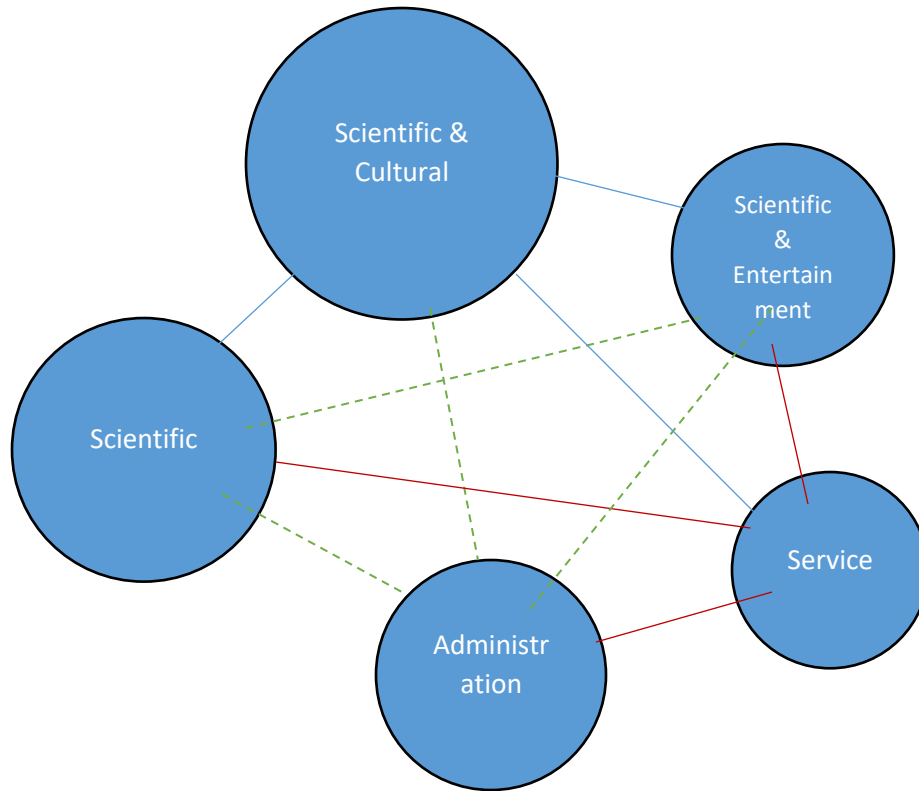

**Design Functional Bubble Diagram**

### Positive Design Points

- Activates are well distributed and clear.
- The design concept of the buildings are remarkable and considered a landmark looking at the nature of the structural elements, which are used, and attract tourists.
- The entrances to the site are distributed well and clear.

### Negative Design Points

- The design was constructed on long periods, which Reflected on the shape of the volumes.
- The area is quite large which affects the circulation on foot for the visitors.

# Khartoum Complex of Science and Technology

K C S T

## Chapter Three

### *Data analysis*

*(Project Components, Area Schedules, Functional Diagrams and Site Analysis)*





### 3-1 | Project Components Diagrams

They are divided into three categories

1. Activity Components.
2. Human components.
3. Spaces Components.

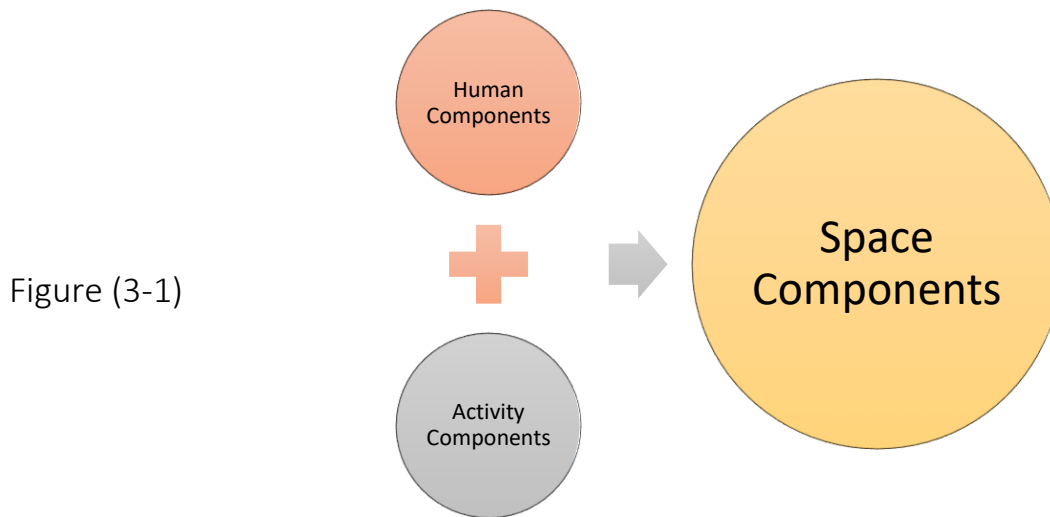

#### 3-1-1 | Activity Components Diagrams

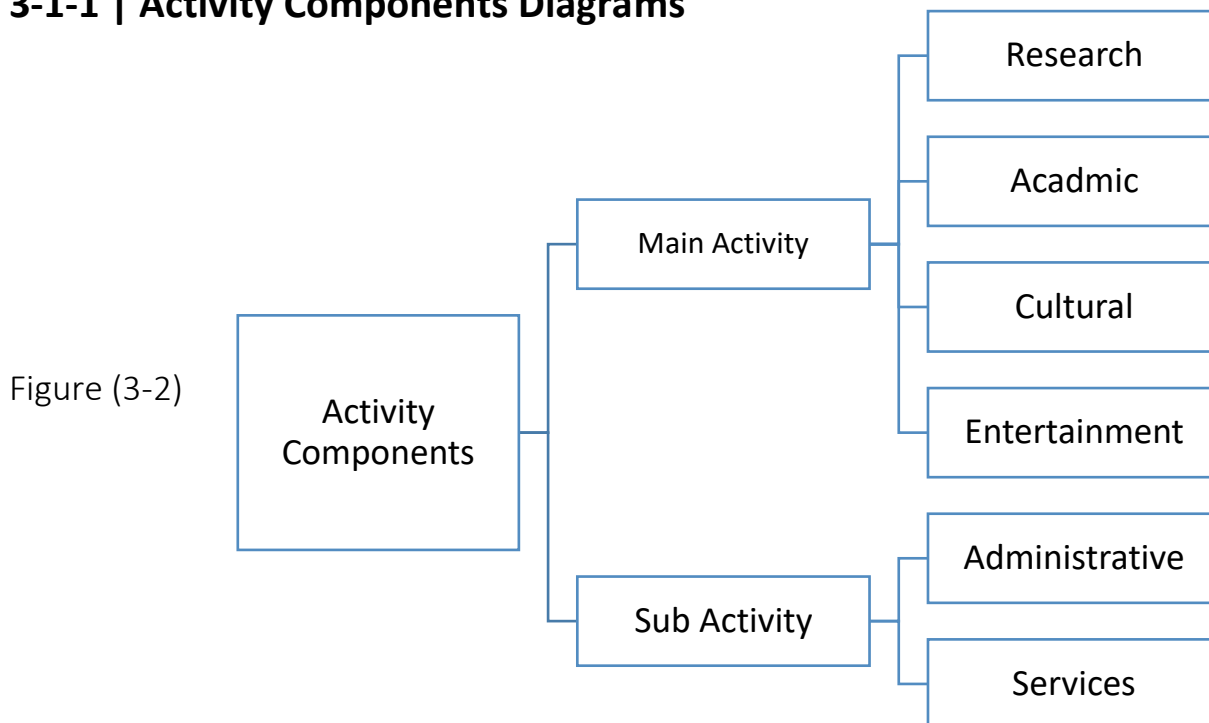

### 3-1-1 | Activity Components Diagrams

Figure (3-3)

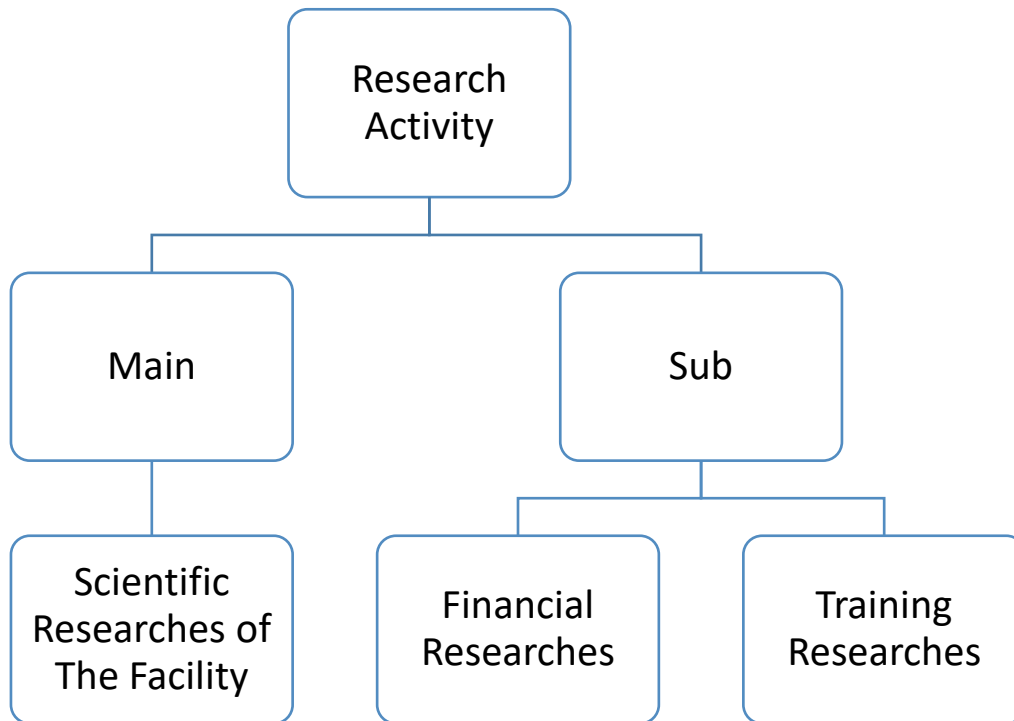
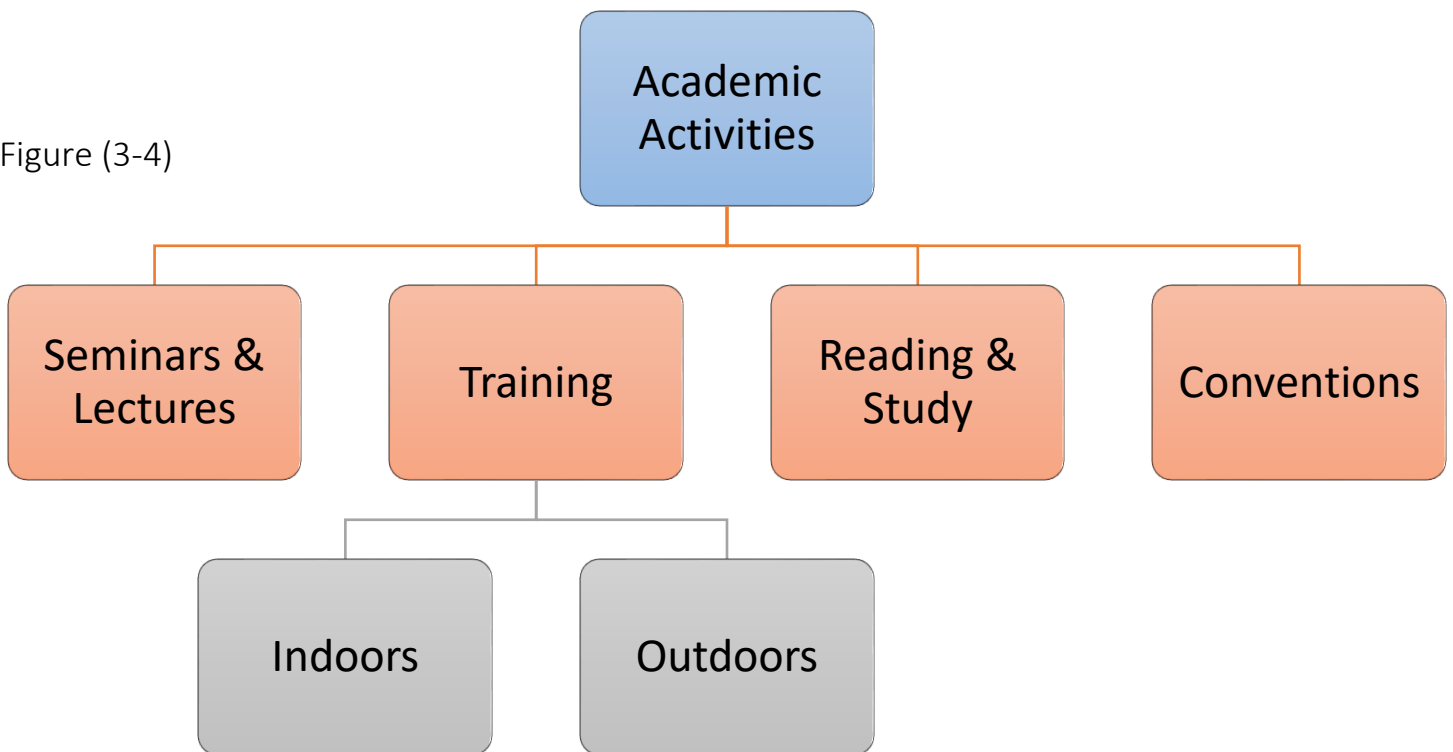

Figure (3-4)



### 3-1-1 | Activity Components Diagrams

Figure (3-5)

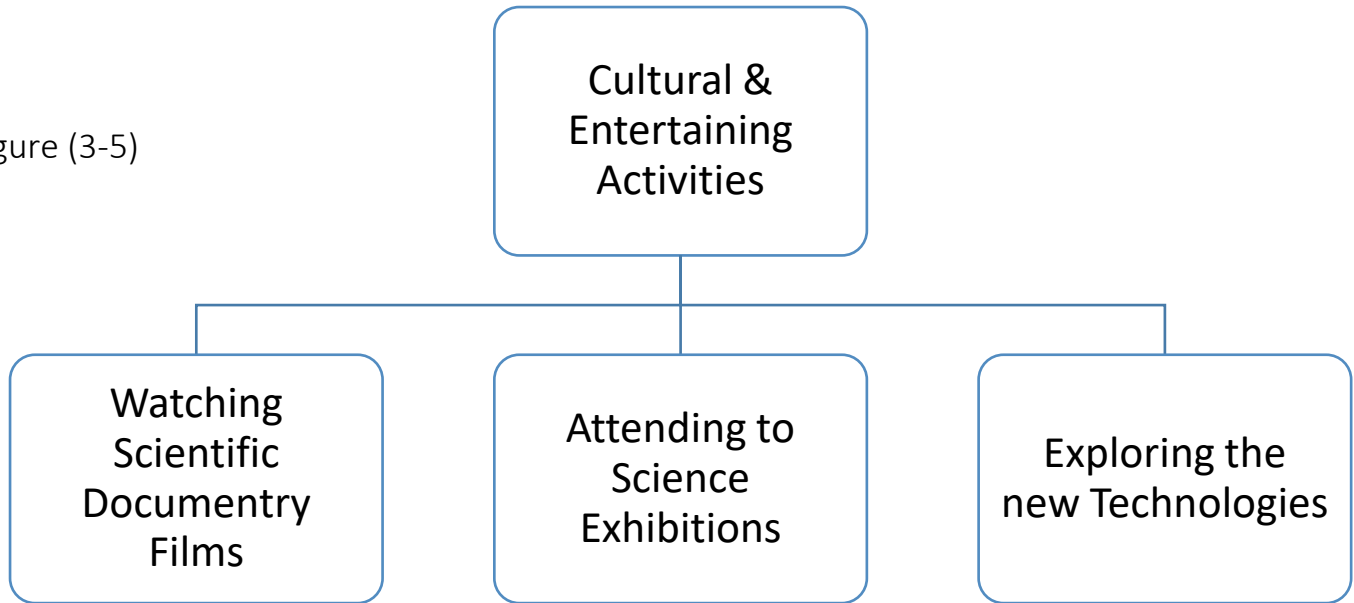

Figure (3-6)

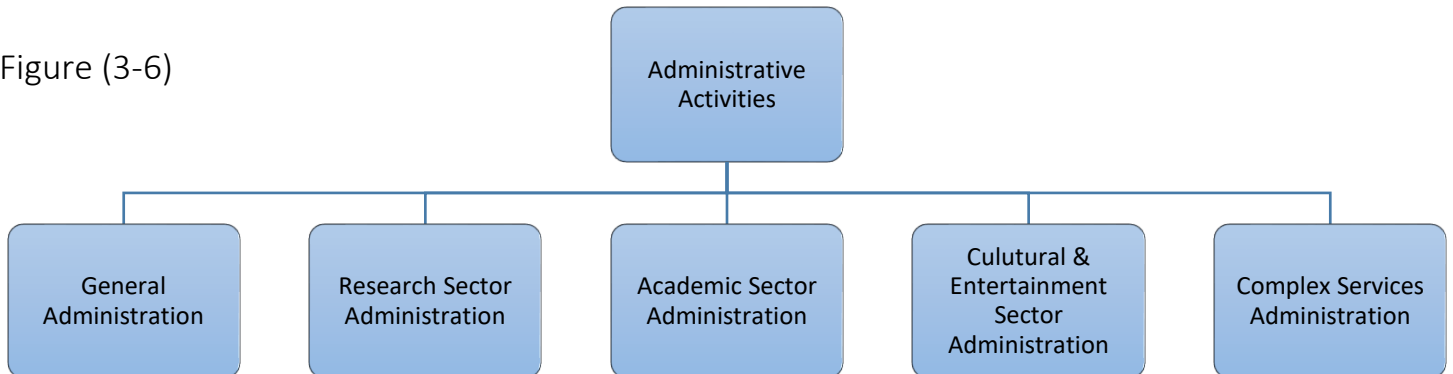
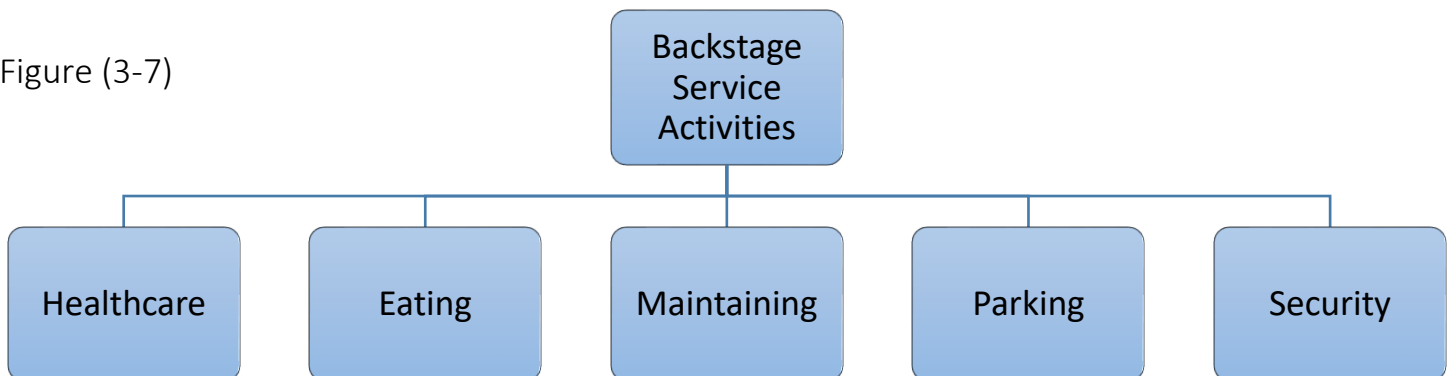
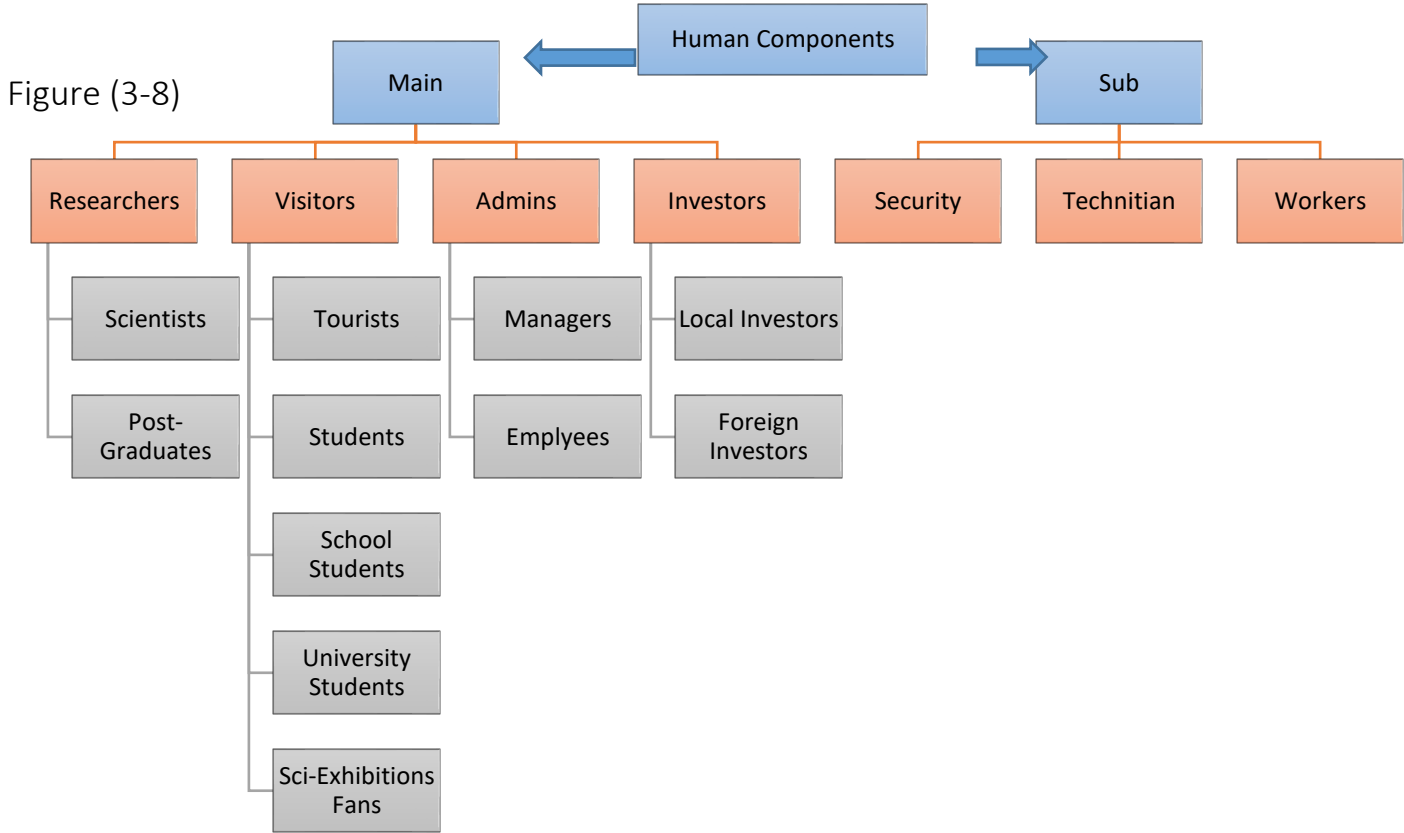

Figure (3-7)



### 3-1-2 | Human Components Diagram



### 3-1-3 | Space Components Diagram

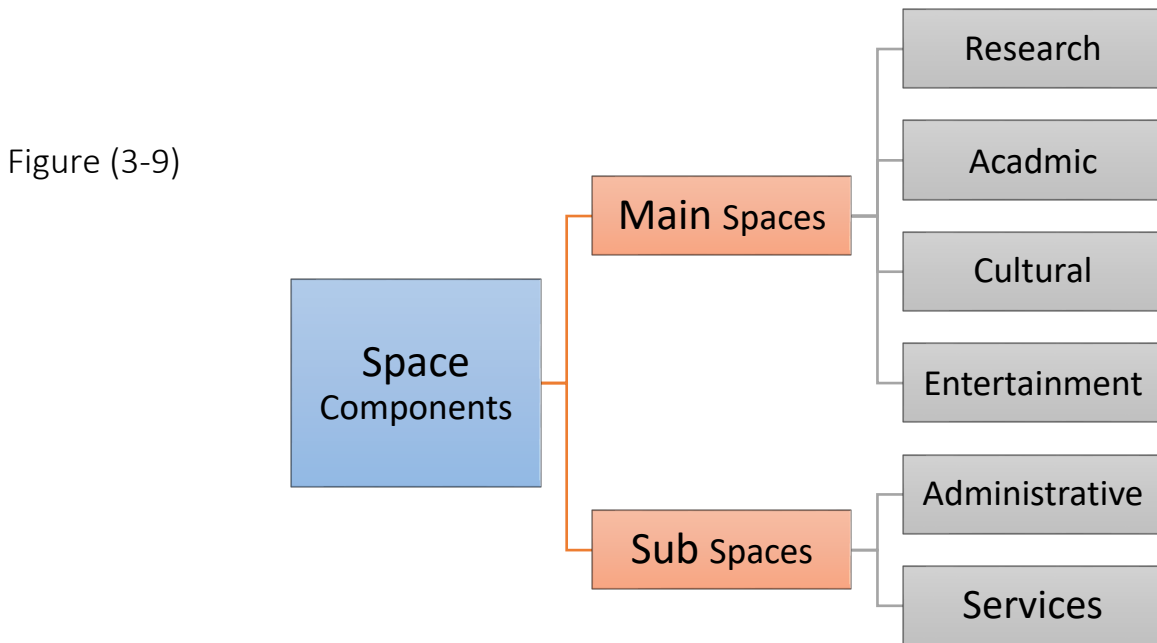

### 3-1-3 | Space Components Diagram

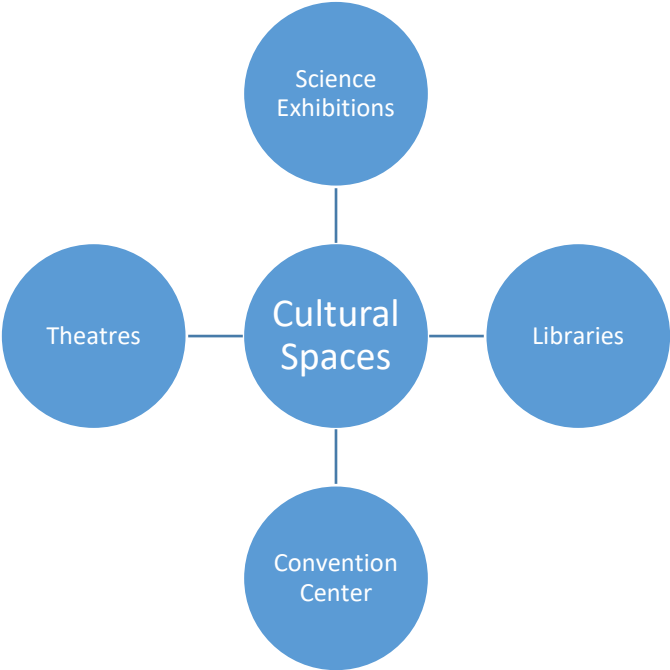
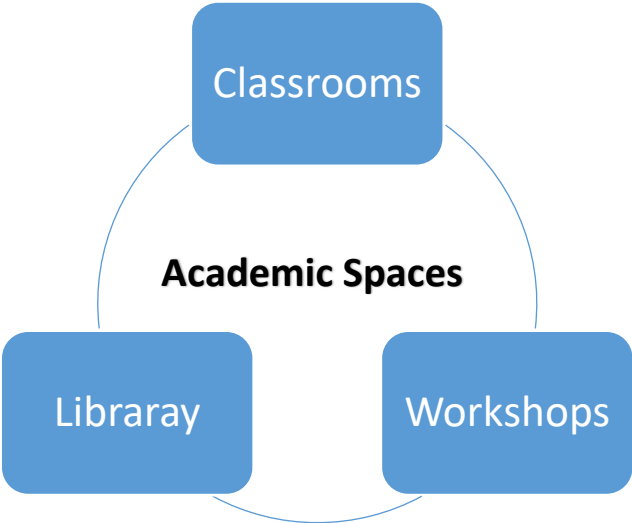

### 3-2 | Architectural Function Diagrams

Figure (3-10)

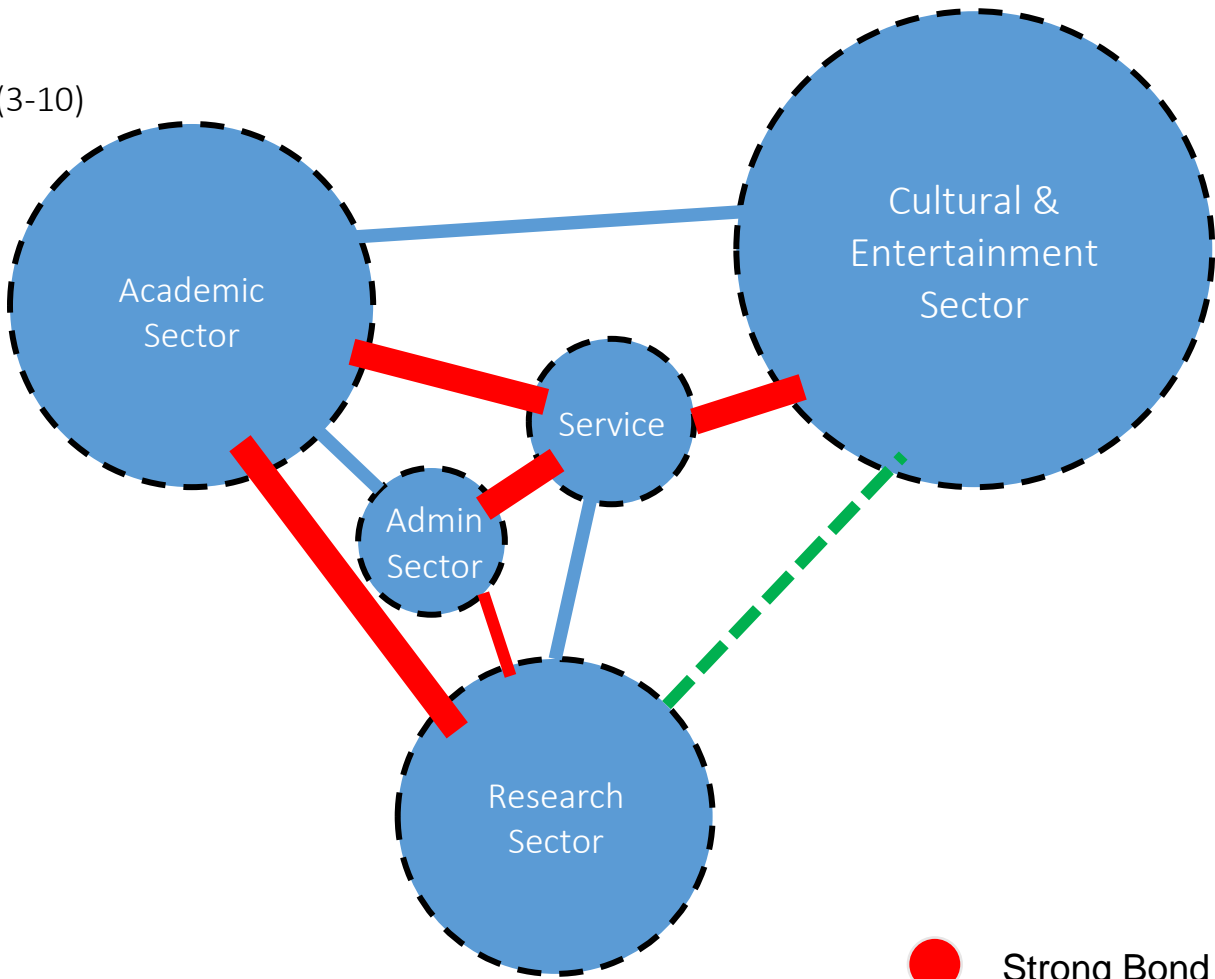
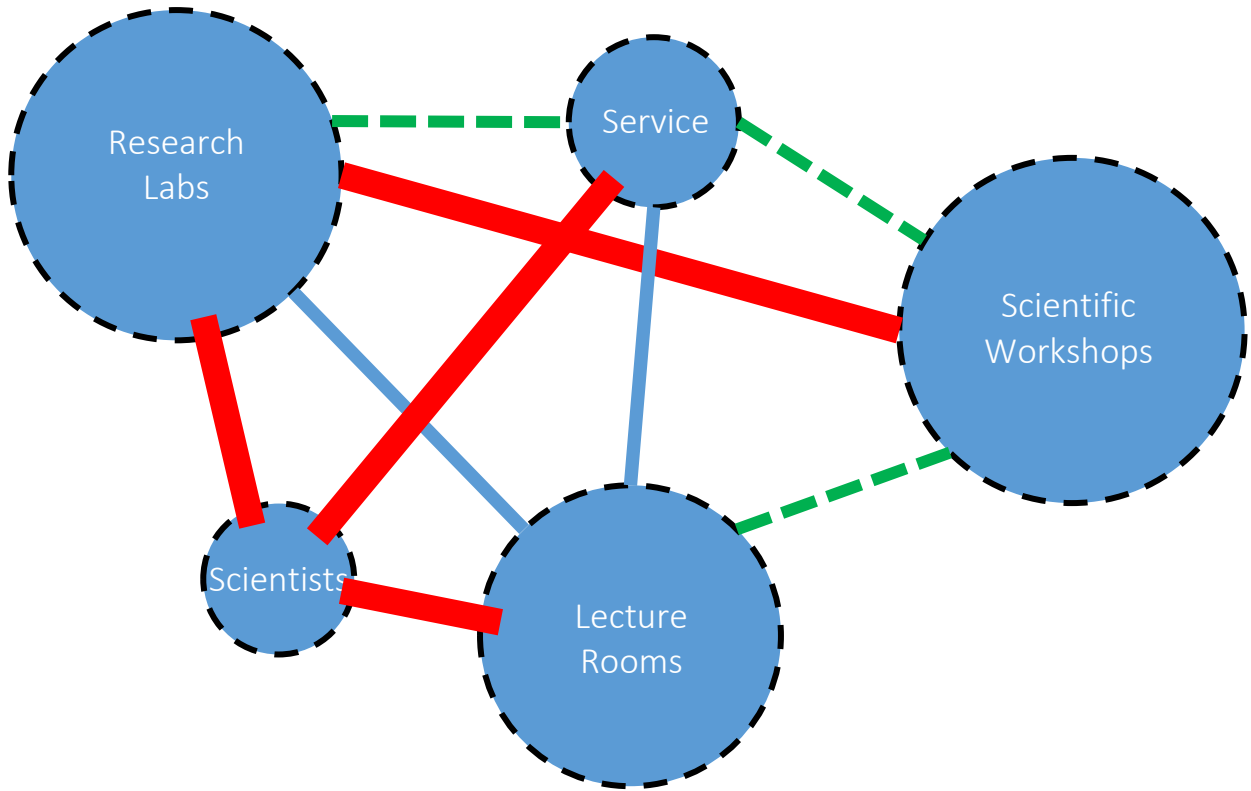

Figure (3-11)

- Strong Bond
- Medium Bond
- Weak Bond

General Activities	
Research Activities & Spaces	
Academic Activities & Spaces	● ● ●
Cultural Activities & Spaces	● ● ● ● ●
Administrative Activities & Spaces	● ● ● ● ● ● ● ●
Serving Activities & Spaces	● ● ● ● ● ● ● ●

### 3-2 | Architectural Function Diagrams



- Strong Bond
- Medium Bond
- Weak Bond

Research Activities	
Physics & Chemistry Labs	
Computer Labs	<span style="color: green;">●</span>
Nano Technology Labs	<span style="color: red;">●</span> <span style="color: red;">●</span> <span style="color: red;">●</span> <span style="color: green;">●</span>
Information Technology Labs	<span style="color: red;">●</span> <span style="color: red;">●</span> <span style="color: red;">●</span> <span style="color: green;">●</span> <span style="color: blue;">●</span>
Advanced Technology development Labs	<span style="color: red;">●</span> <span style="color: red;">●</span> <span style="color: blue;">●</span> <span style="color: blue;">●</span> <span style="color: blue;">●</span> <span style="color: red;">●</span> <span style="color: blue;">●</span>
Communication Technology Labs	<span style="color: red;">●</span> <span style="color: blue;">●</span> <span style="color: blue;">●</span> <span style="color: blue;">●</span> <span style="color: red;">●</span> <span style="color: blue;">●</span> <span style="color: green;">●</span> <span style="color: blue;">●</span>
Researchers Offices	<span style="color: blue;">●</span> <span style="color: red;">●</span> <span style="color: green;">●</span> <span style="color: green;">●</span>
Scientific Workshops	<span style="color: red;">●</span> <span style="color: red;">●</span> <span style="color: green;">●</span>
Library	<span style="color: red;">●</span>

### 3-2 | Architectural Function Diagrams

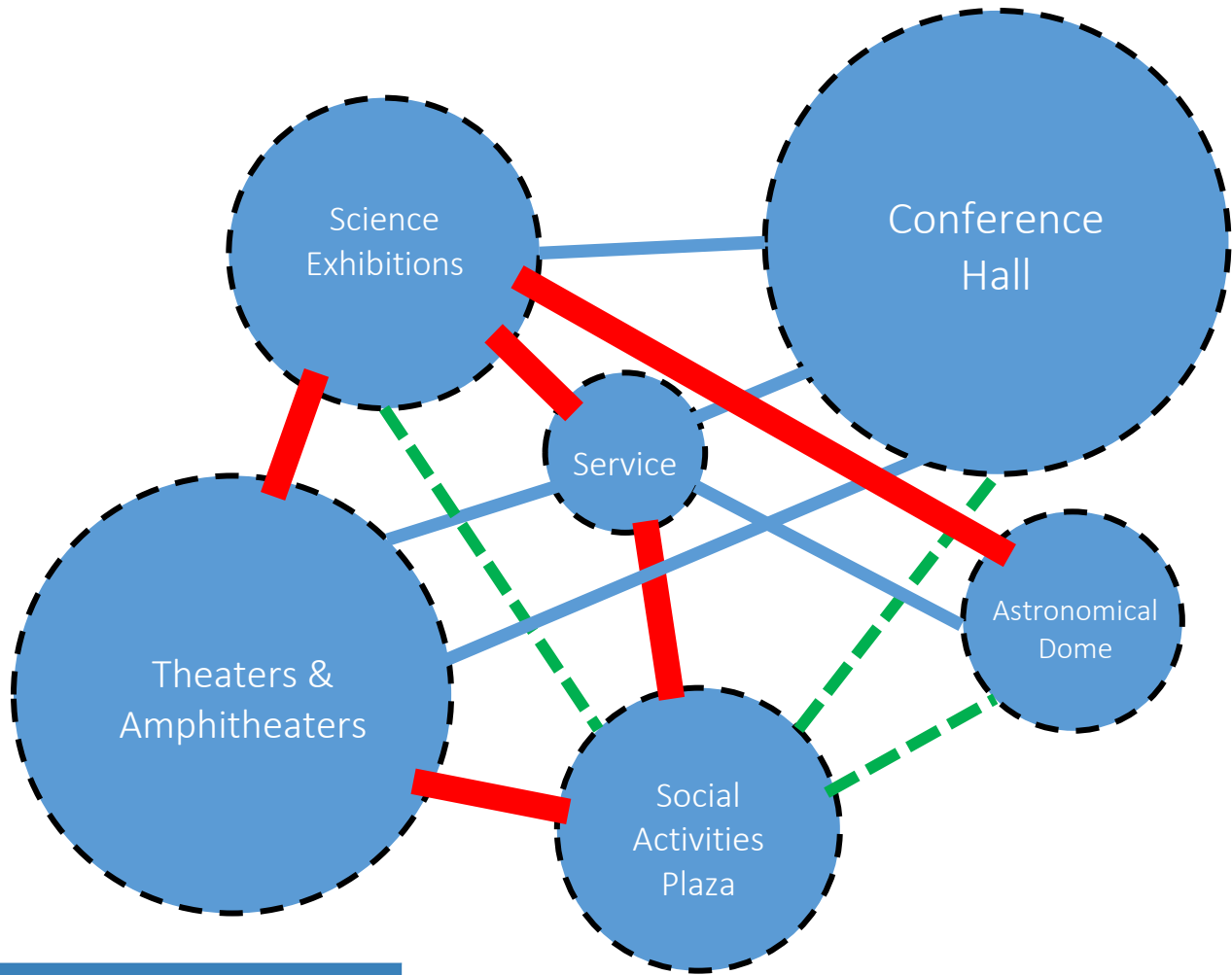

Cultural Activities	
Science Exhibitions	
Convention Center	●●
Theatres	●●●
Library	●
Academic Activities	
Classrooms	
Workshops	●●
Theatre	●●●
Library	●

- Strong Bond
- Medium Bond
- Weak Bond



### 3-2 | Architectural Function Diagrams

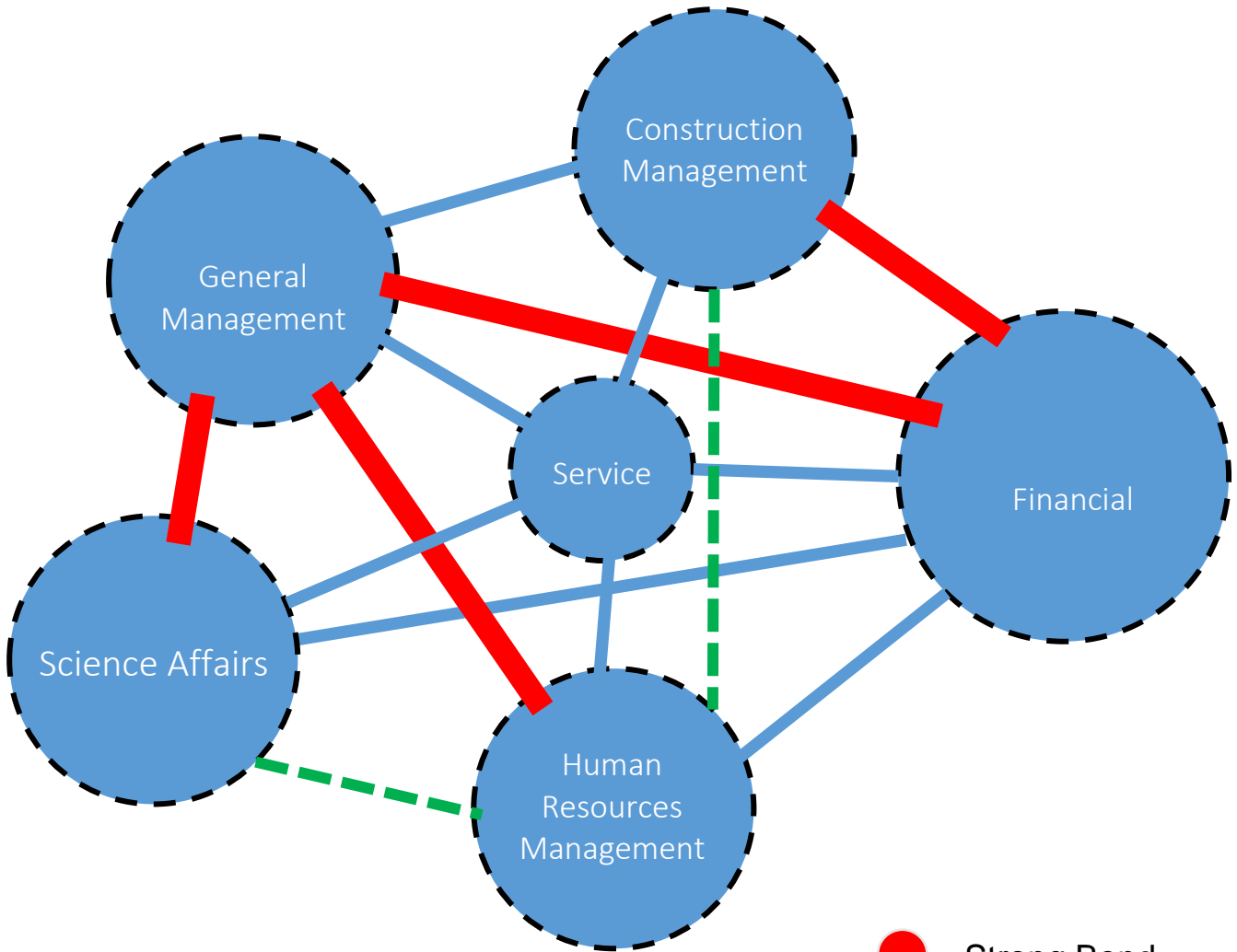

- Strong Bond
- Medium Bond
- Weak Bond

Administrative Activities	
Managers Offices	
Departments Chiefs Offices	●
Employees Offices	● ● ●
Scientists Offices	● ● ● ●
Additional Offices & Rooms	● ● ● ● ●

### 3-3 | Area Calculation Tables

Activity Category	Spaces	Number of Users	Number of Spaces	Area of Space M	Total Area
<b>Administration</b>	General Manager	1	1	40	40
	Secretary	1	8	16	128
	Reception Hall	50	3	200	600
	Executive Manager	1	1	20	20
	Financial Affairs Manager	1	1	25	25
	Projects Manager	1	1	20	20
	Construction Manager	1	1	20	20
	Training Affairs Manager	1	1	20	20
	External Relations Manager	1	1	20	20
	Science Affairs Manager	1	1	20	20
	Meeting Room	12	3	45	135
	Employees Office	10	7	60	420
Archive	-	8	20	160	

## 3-3 | Area Calculation Tables

Activity Category	Spaces	Number of Users	Number of Spaces	Area of Space M	Total Area
<b>Scientific</b>	Physical Researches Labs	10	2	100	200
	Chemical Researches Labs	10	2	100	200
	Computer Researches Labs	15	3	100	300
	Nano Technology Researches Labs	12	2	120	240
	Information Technology Researches Labs	20	3	100	300
	Advanced Technology Development Labs	10	3	180	540
	Communications Technology Labs	20	3	100	300
	Scientific Workshops	25	8	200	1600
	Scientists Office	4	8	25	200
	Lecture Room	40	3	200	600
	Scientific Conference Hall	120	1	1200	1200

## 3-3 | Area Calculation Tables

Activity Category	Spaces	Number of Users	Number of Spaces	Area of Space M	Total Area
<b>Cultural</b>	Science Exhibition	140	3	1500	4500
	Conference Hall	500	1	2500	2500
	Theatre	300	2	1400	1400
	Astronomical Dome	200	1	1100	1200
	Aquarium	100	1	1000	1000
<b>Academic</b>	Classroom	40	6	200	1200
	Workshop	25	4	200	800
	Library	300	1	1100	1100
	Scientific Experiment Lounge	140	1	1500	1500

Activity Category	Spaces	Number of Users	Number of Spaces	Area of Space M	Total Area
<b>Sci - Entertaining</b>	Imax Theater	100	2	600	1200
	Amphitheater	300	1	1600	1600
	Interactive activities Hall	200	1	2000	2000

### 3-3 | Area Calculation Tables

Activity Category	Spaces	Number of Users	Number of Spaces	Area of Space M	Total Area
<b>Service</b>	Restaurant	60	3	480	1440
	Cafe	40	2	120	240
	Warehouse	-	3	150	450
	Mosque	60	2	120	240
	Lavatories	6	20	30	600
	Maintenance Workshop	10	4	120	480
	Security Office Check Point	3	6	20	120
	Parking	600	600	25	15000

#### - Total Sectors Area

Sector	Total Area m <sup>2</sup>
Research Sector	7,120
Cultural Sector	13,000
Academic Sector	8,600
Entertainment Sector	6,200
Administrative Sector	1,860
Service Sector	5,570
Parking	15,000
<b>Total Built Area</b>	<b>57,350</b>

## - Area Percentage Diagram

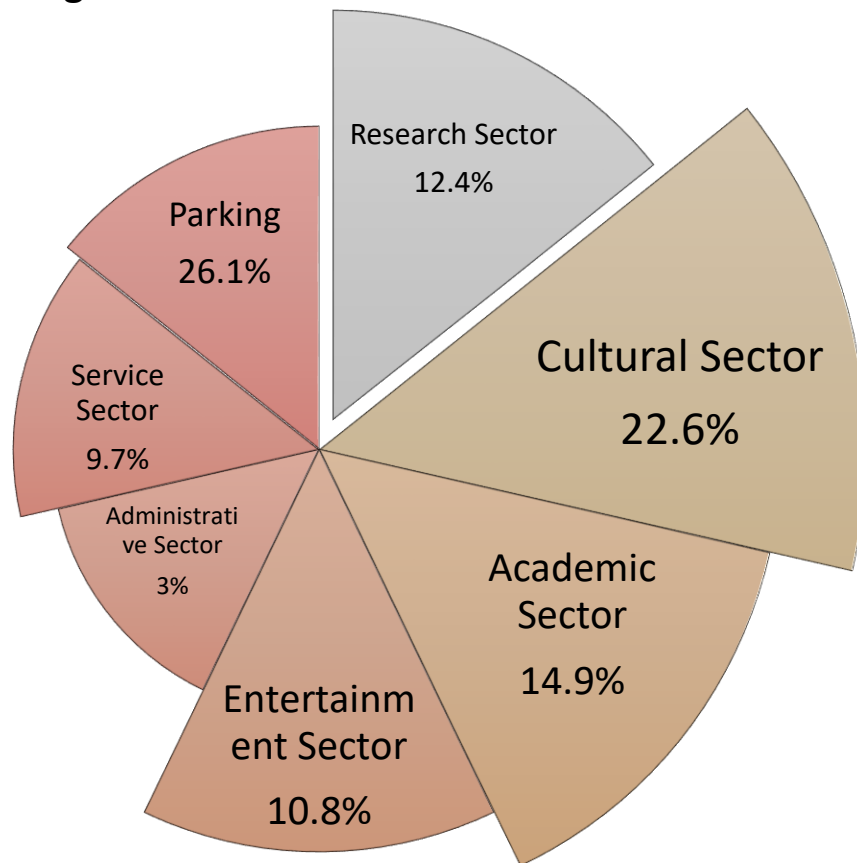

The Percentage Diagram Shows the percentage of the total area of each sector from the proposed built area

40% of the total Area is added as an outdoor landscape and 20% of it is added for the amphitheater and the outdoor pools living us with a total area of 91,760 m<sup>2</sup>

3-4 | Users Circulation Diagrams

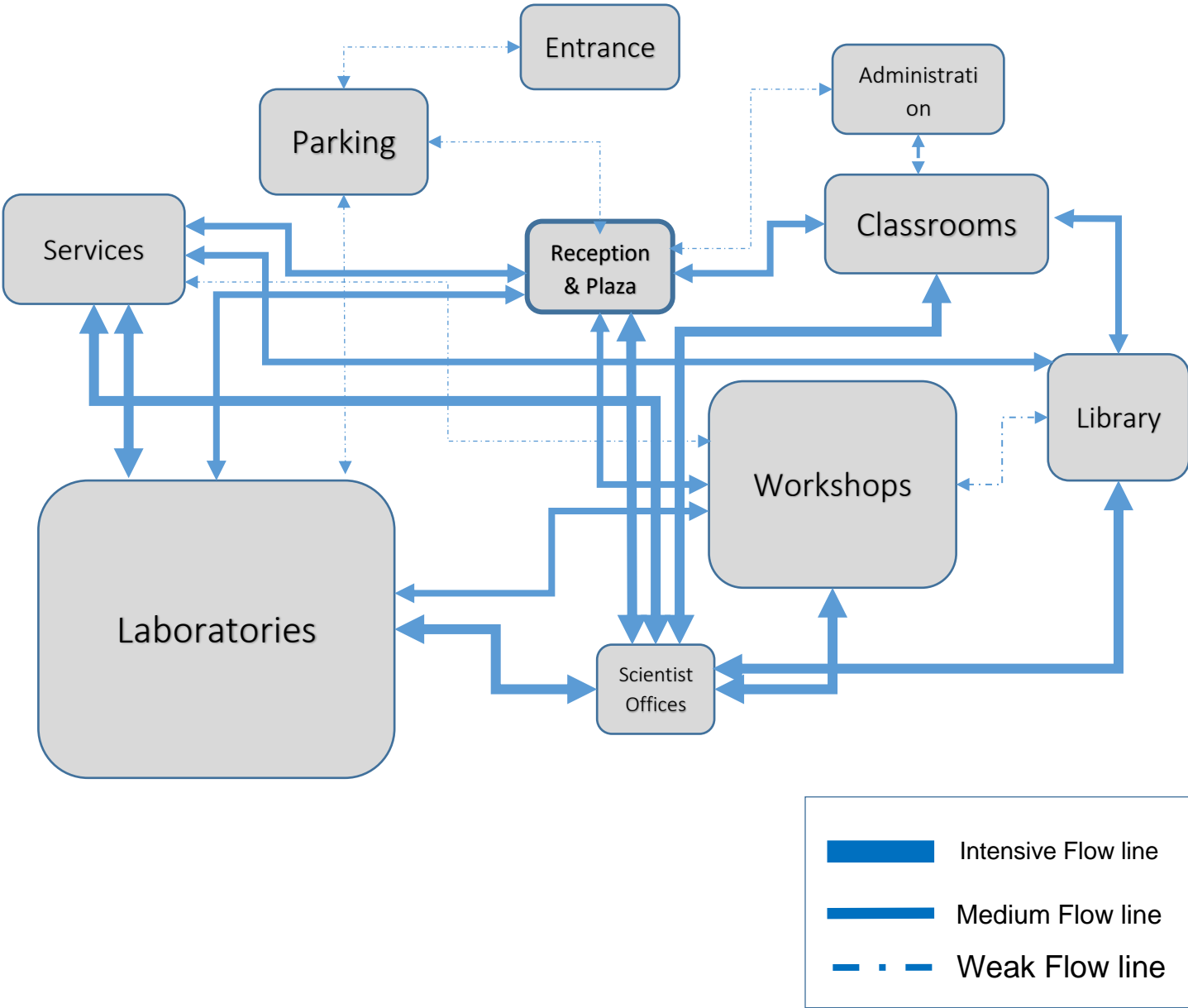

### 3-4 | Users Circulation Diagrams

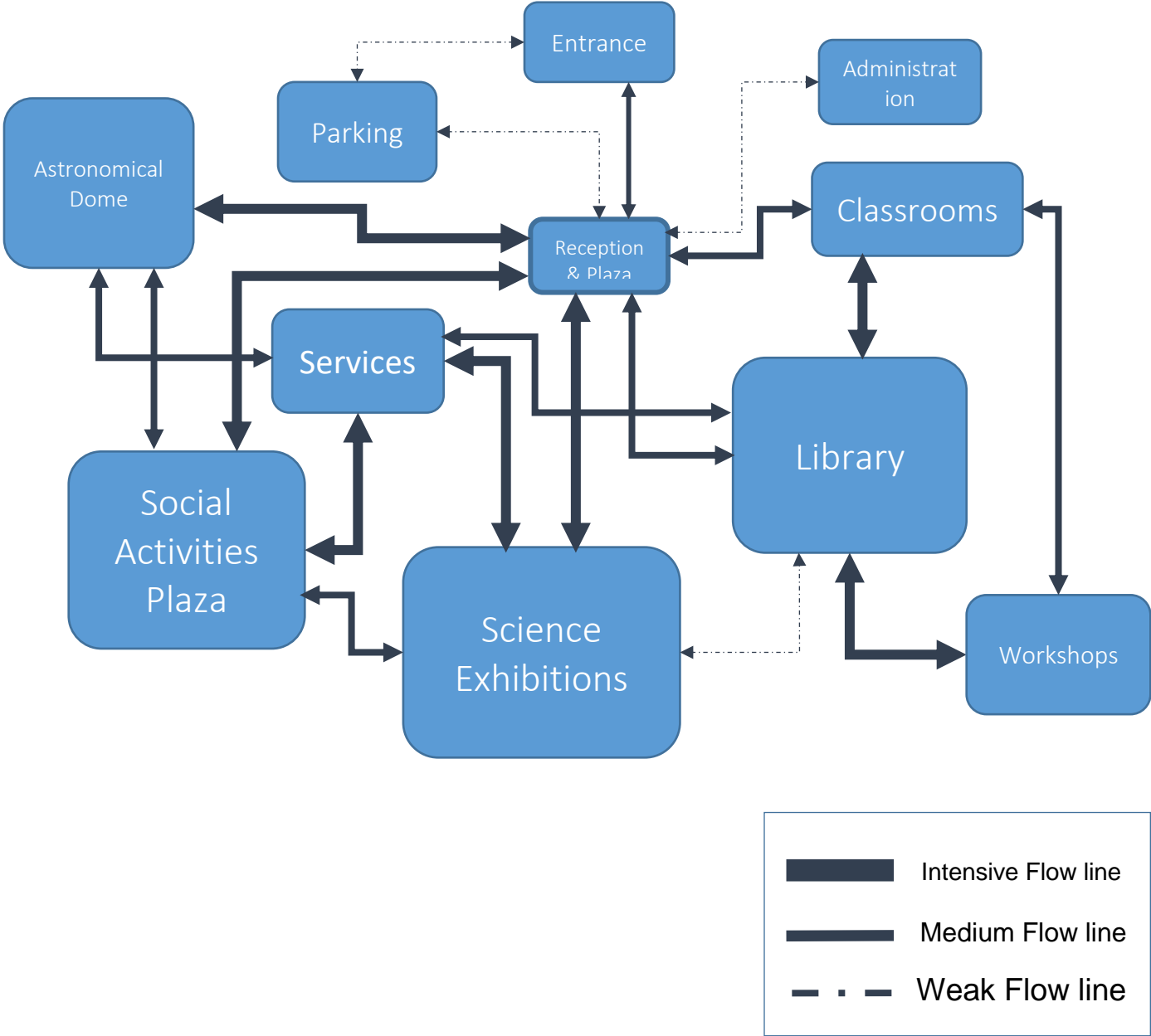



### 3-4 | Users Circulation Diagrams

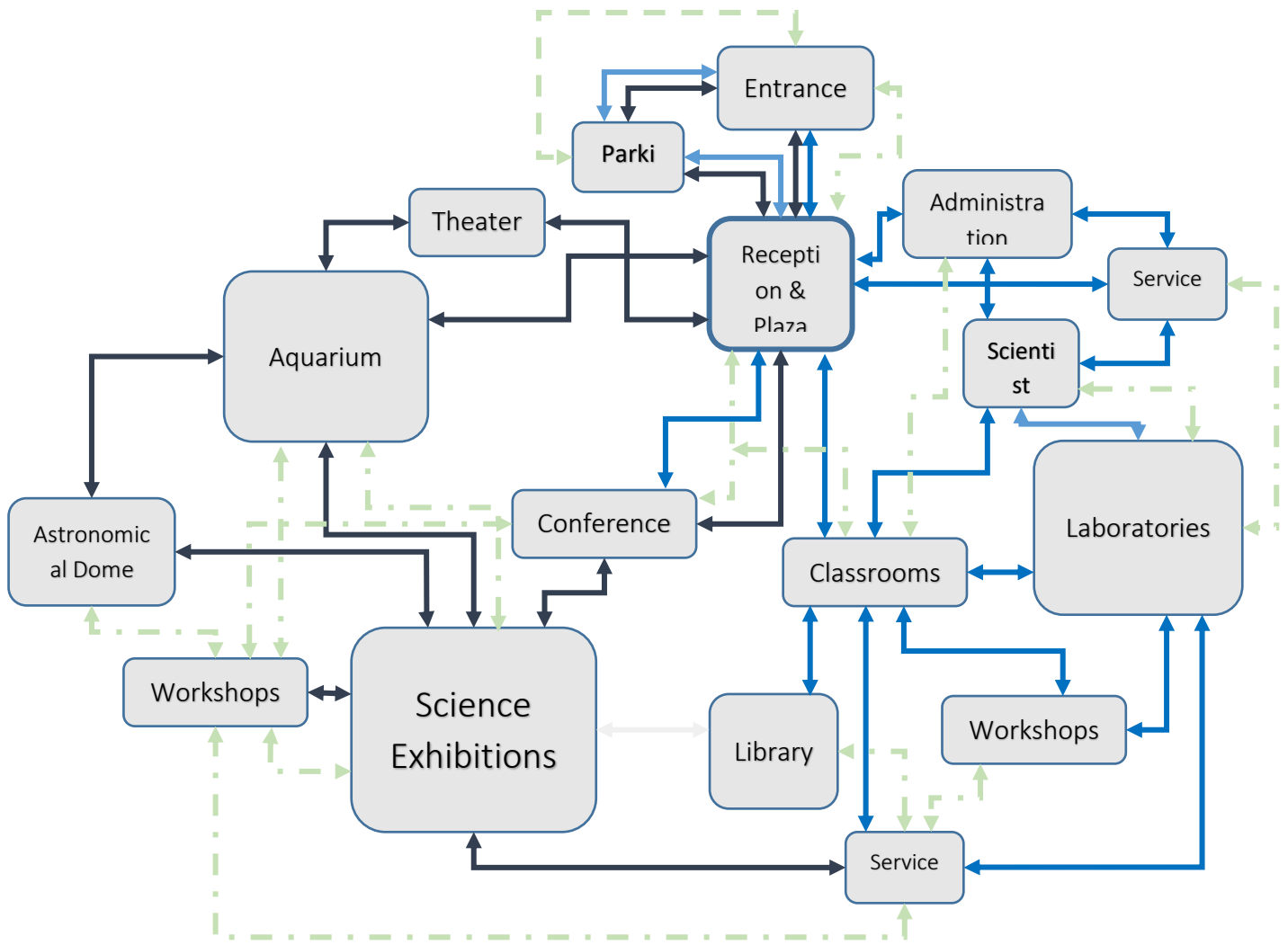

### 3-5 | Proposed Location Overview

**Proposal No. 1** Site is located in Khartoum State – Khartoum City at Soba Al-Hilla Area the coordinates are (15°29'37.1"N 32°39'18.3"E).

Near the Proposed Africa Science City. The Accessibility of the Location is from Madani Highway Street With a total Area of (136,763 m<sup>2</sup> – 13.67 Hectares) and about 13.32 km from the center of the city.

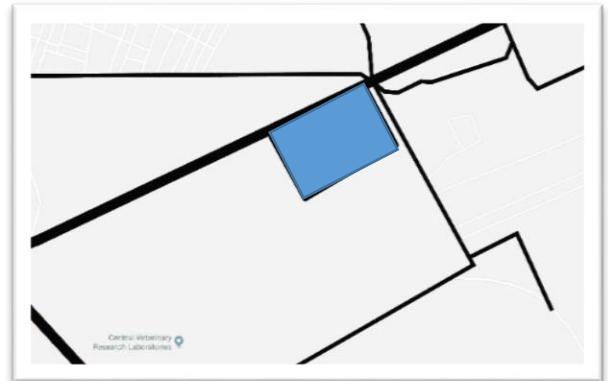

**Proposal No. 1**

**Proposal No. 2** Site is located in Khartoum State – Omdurman City at Salha District the coordinates are (15°30'46.2"N 32°25'03.8"E). Near Al-Dbaseen Bridge.

The Accessibility of the Location is from Salha Street With a total Area of (102,518 m<sup>2</sup> – 10.25 Hectares) and about 15.60 km from the center of Khartoum city and 10.00 km From Omdurman City.



**Proposal No. 2**

**Proposal No. 3** Site is located in Khartoum State – Khartoum City at Near Umm Dawm Area the coordinates are (15°31'23.7"N 32°39'48.2"E). In front of the Blue Nile River.

The Accessibility of the Location is from Al-Manshia Bridge Street South Highway Street With a total Area of (126,753 m<sup>2</sup> 12.67 Hectares) and about 10.46 km from the center of the city.



**Proposal No. 3**

### 3-5 | Proposed Location Overview

- Comparison Table

Standard	Percentage %	Percentage of the Proposed Sites		
		Proposal 1	Proposal 2	Proposal 3
Site Total Proposed Area	20%	15%	17%	19%
Site Functionality	15%	10%	12%	9%
Location Accessibility	10%	9%	8%	5%
Neighbors and Surroundings	10%	8%	10%	6%
Environmental Surrounding Effects	15%	12%	14%	10%
Location Infrastructure Availability	15%	11%	15%	8%
Property Cost	5%	4%	4%	3%
Cultural Value to the Area	10%	7%	9%	5%
Total Score	100%	76%	89%	65%

**Proposal No. 2** Site is located in Khartoum State – Omdurman City at Salha District the coordinates are (15°30'46.2"N 32°25'03.8"E). Near Al-Dbaseen Bridge.

The Accessibility of the Location is from Salha Street With a total Area of (102,518 m<sup>2</sup> – 10.25 Hectares) and about 15.60 km from the center of Khartoum city and 10.00 km From Omdurman City.



### 3-6 | Site Environmental Analysis

The sun path Diagram above shows that angles of the sun are almost vertical with 80 degrees at midday in June with a day period of 13 hours and 50 degrees at December with a day period of 11 hours.

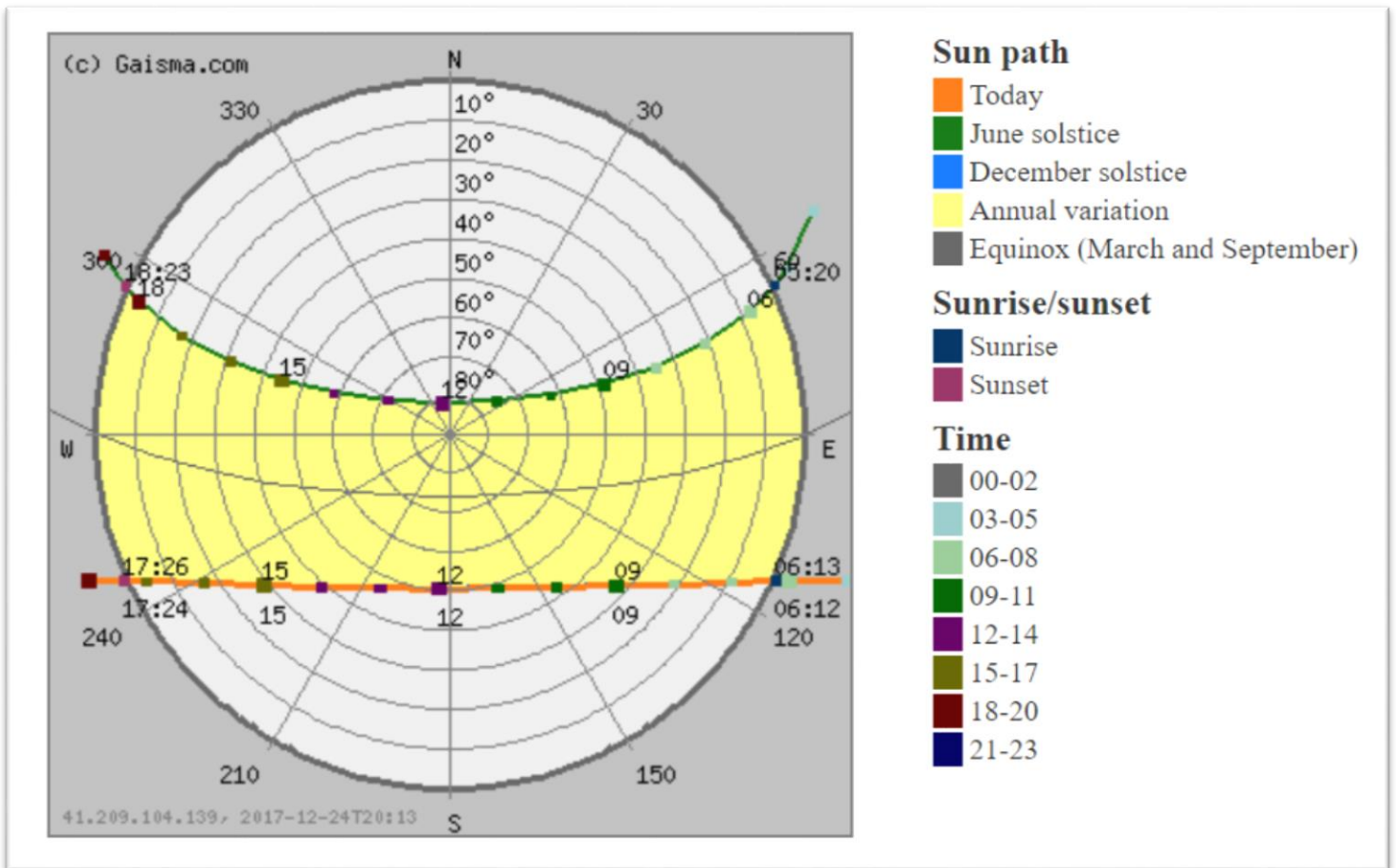
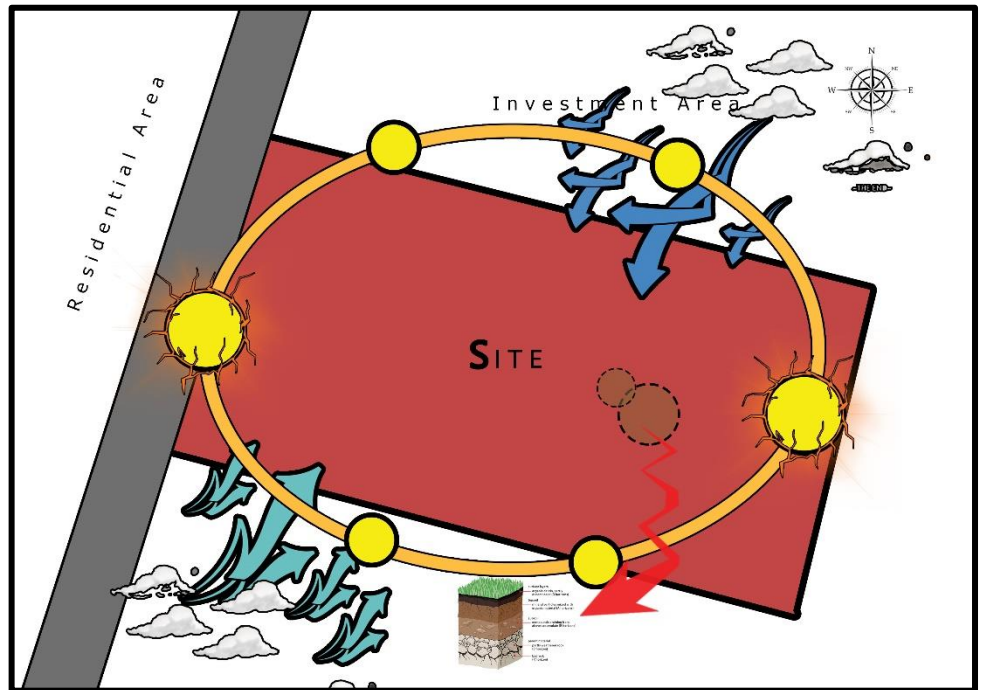

### 3-6 | Site Environmental Analysis

**Temperature** the Diagram next shows the temperature ratios of Khartoum with above 40° most days of April, May, June and September and 35° in half of Mar, July, August and November

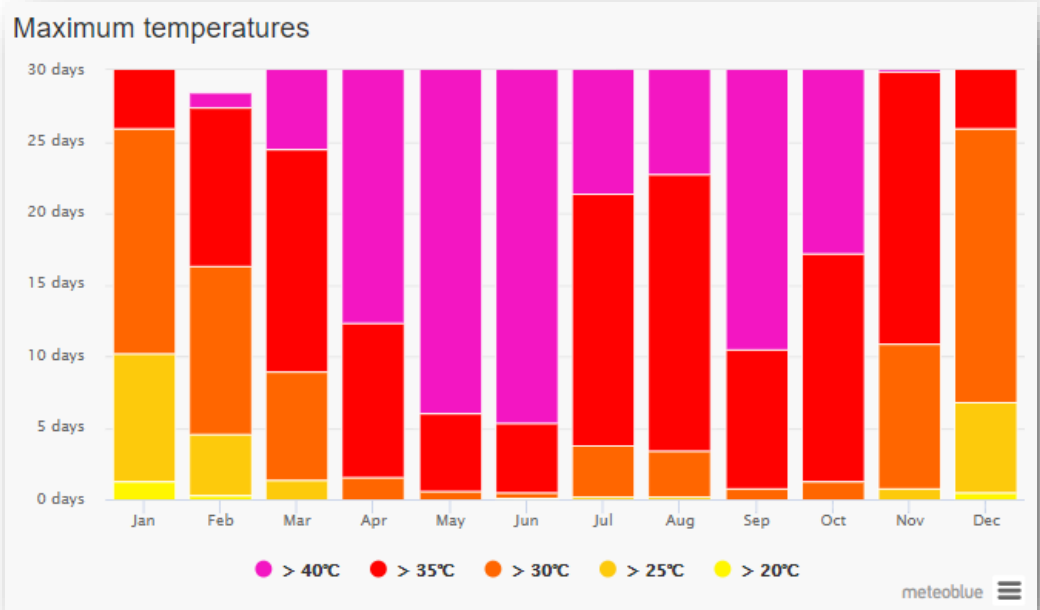

**Overcast** the Diagram next shows the state is sunny most of the year except the rainy months July, August and September which appears to be part cloudy most days of July and August

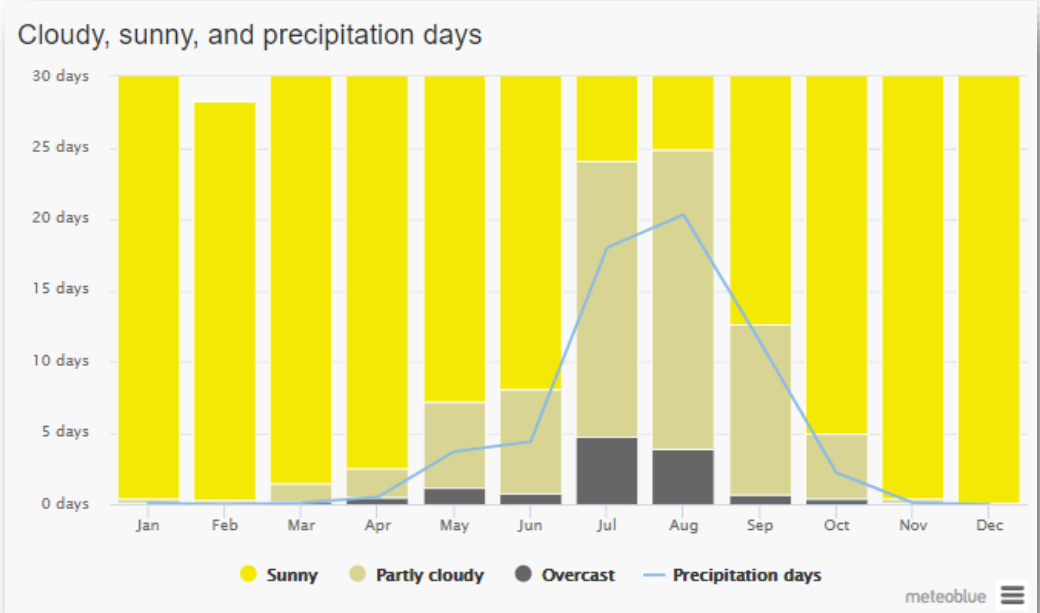

### 3-6 | Site Environmental Analysis

**Precipitation** the Diagram above shows the state is dry most of the year with a little amount of precipitation in July, August and September in a range of 11-20 days which is 2-5mm at minimum and 10-20mm at maximum

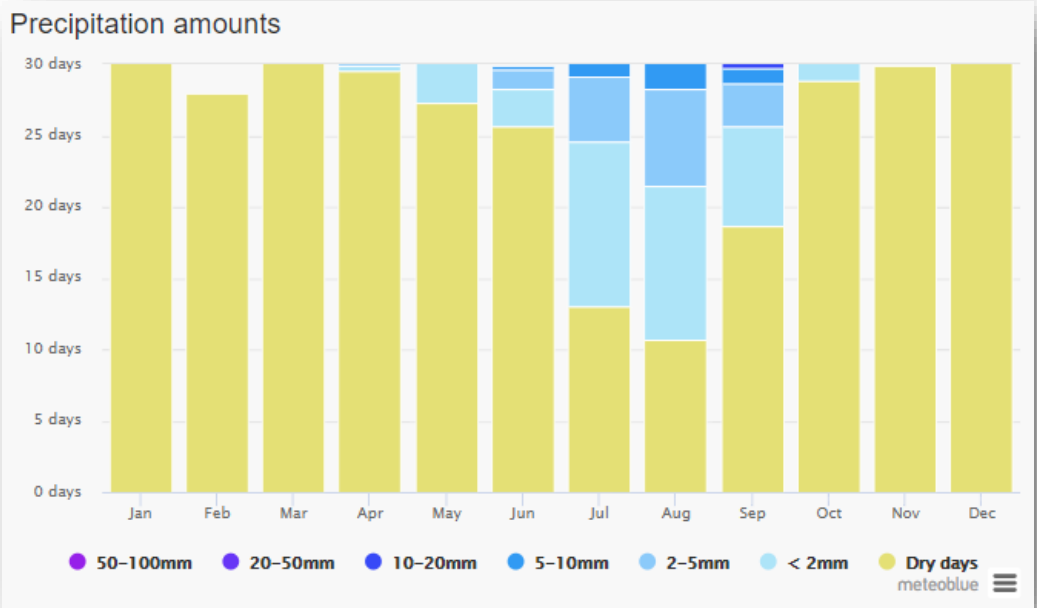

**Wind** the Wind Rose Diagram of Khartoum shows that the northern winds and the NNW have the

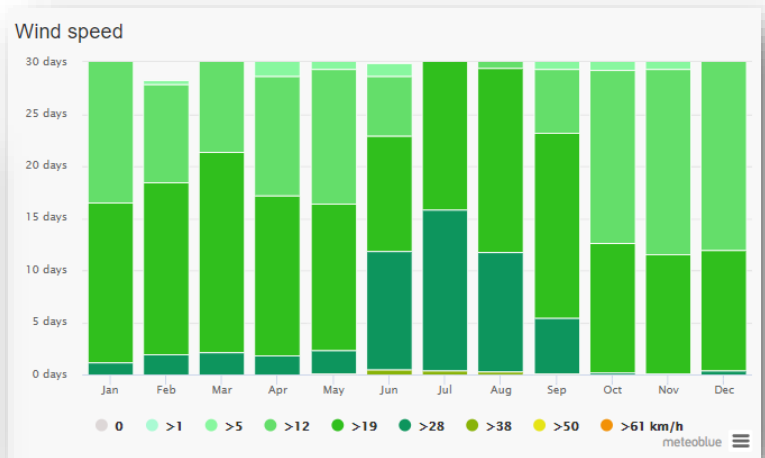
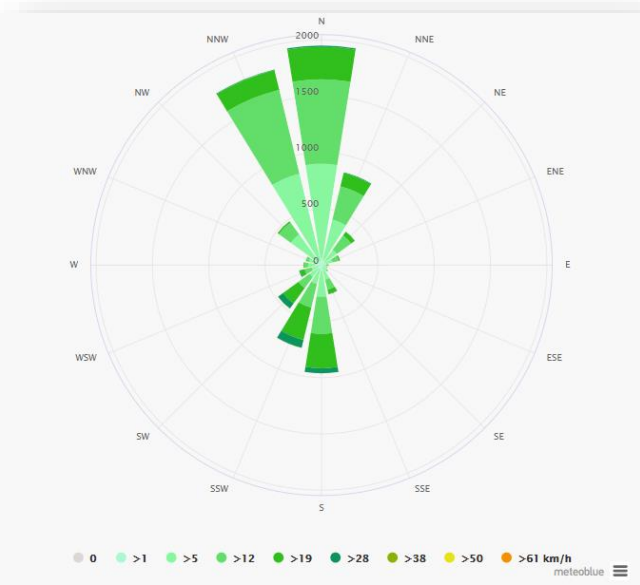

most durability with an average of 793.5 h/y and a speed average of 15.5 km/h. comes in second the Southern Winds with a durability of 317.5 h/y and An Average of Speed 11.5 km/h.

The diagrams also shows that there is almost no blowing wind from east and west.

### 3-7 | *Design Guide Lines*

- ⊙ All the sensitive spaces such as labs and scientific workshops should be protected and isolated from air dust and dirt.
- ⊙ The spaces should be thermal isolated using heat reflectors and thermal isolation materials.
- ⊙ The public spaces should be ventilated and lighted naturally.
- ⊙ Noise blocking materials should be considered in the process of constructing the buildings of the facility.
- ⊙ Any quiet space should be isolated and zoned away from the noisy zones.
- ⊙ The services should be well distributed throughout the whole area of the site to cover almost all the zones.
- ⊙ The circulation between the zones should be considered looking at the nature of the projects from the public zones to the private staff only zones.
- ⊙ The parking area should be isolated for clean environment away from the heavily crowded areas.
- ⊙ The design should be flexible and should consider the future expansion of the facility in any sector.
- ⊙ The building design should be adapting to the new tech, which will be developed and invented in the complex.
- ⊙ Looking at the nature of the project and the amount of users the spaces must be designed to be semi-opened if it's not fully opened to give the user the feel of comfort and take away any feel of crowdedness.

3-8 | Design Zoning

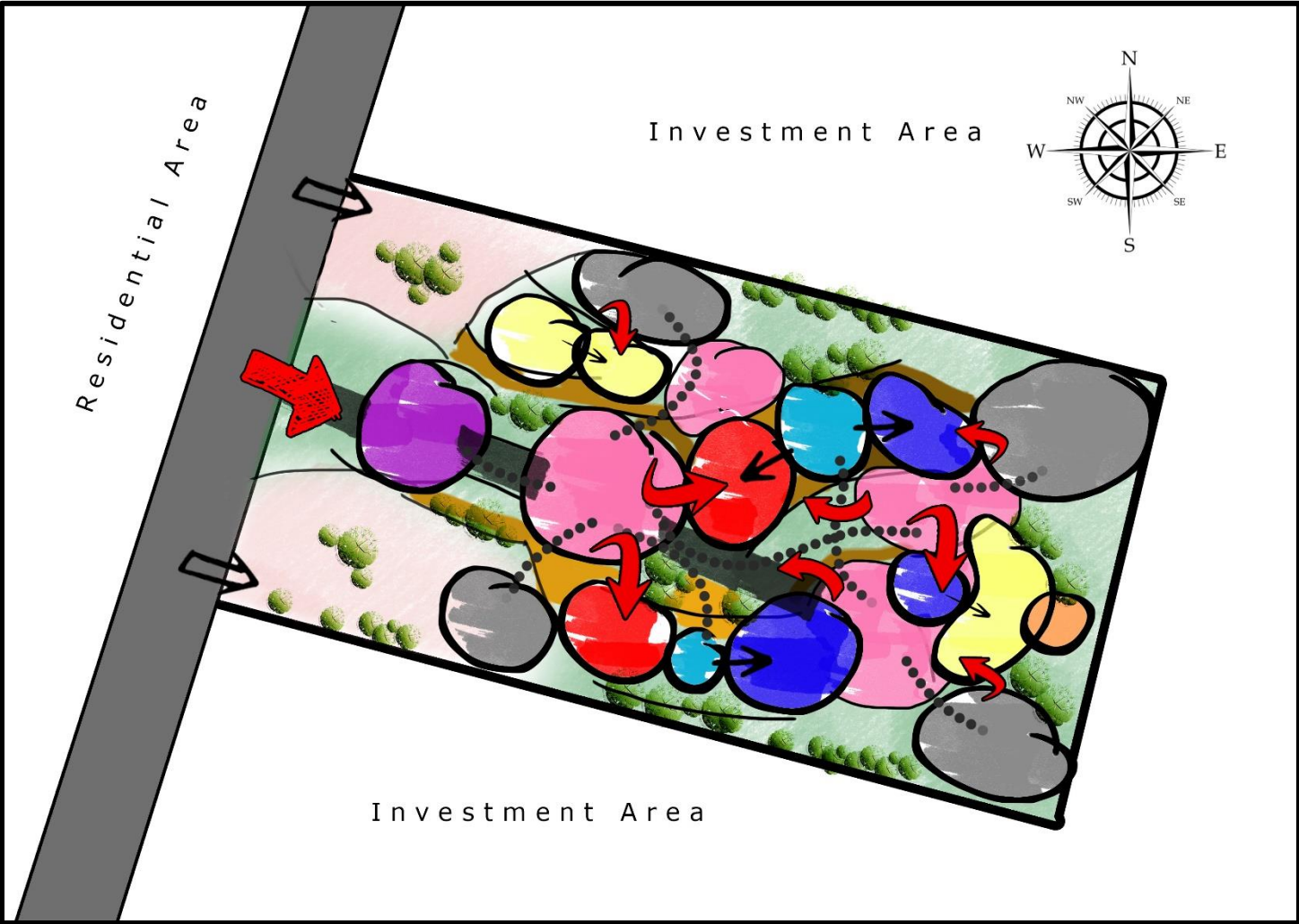

The Zoning above shows the main sectors of the complex as an activity.

- Academic
- Entertainment
- Entrance
- Landscape
- Research
- Open Plaza
- Service
- Parking
- Cultural



# Khartoum Complex of Science and Technology

K C S T

## Chapter Four *Project Design*



## Project Design

In this chapter, the phases of the design will be explained and discussed from the conceptual idea to the development of the concept and finally ending with the final presentation of the project.

### 4-1 | Complex Design Concept

Khartoum complex of science and technology mainly as a definition is a multiple buildings that serve students and researchers. So the concept was depending on providing an interactive community and environment so they can practice their activities separately, and also having

The complex contains four main activities and they are the educational, the cultural, the research and the entertainment sector and they are all connected though the public outdoor spaces from plazas and what so similar.

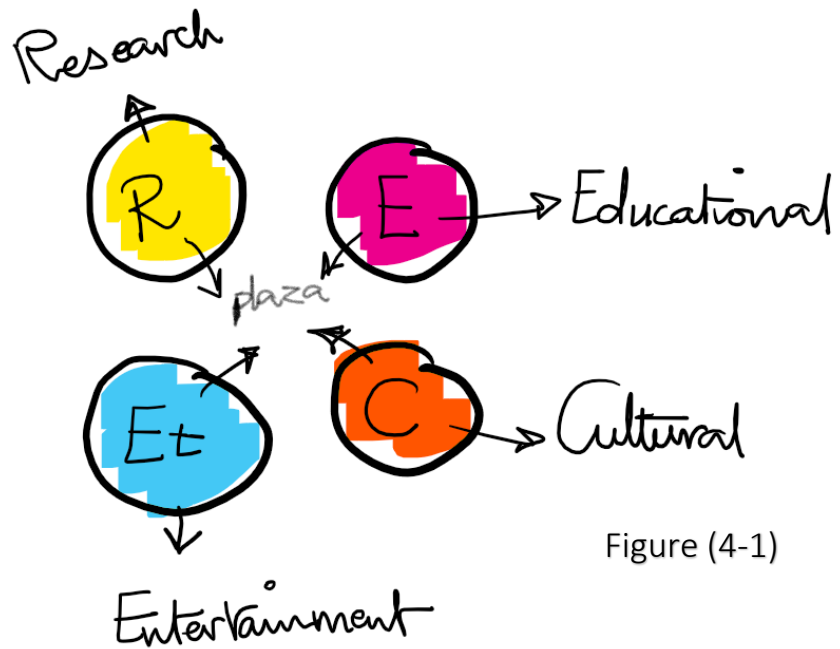

Figure (4-1)

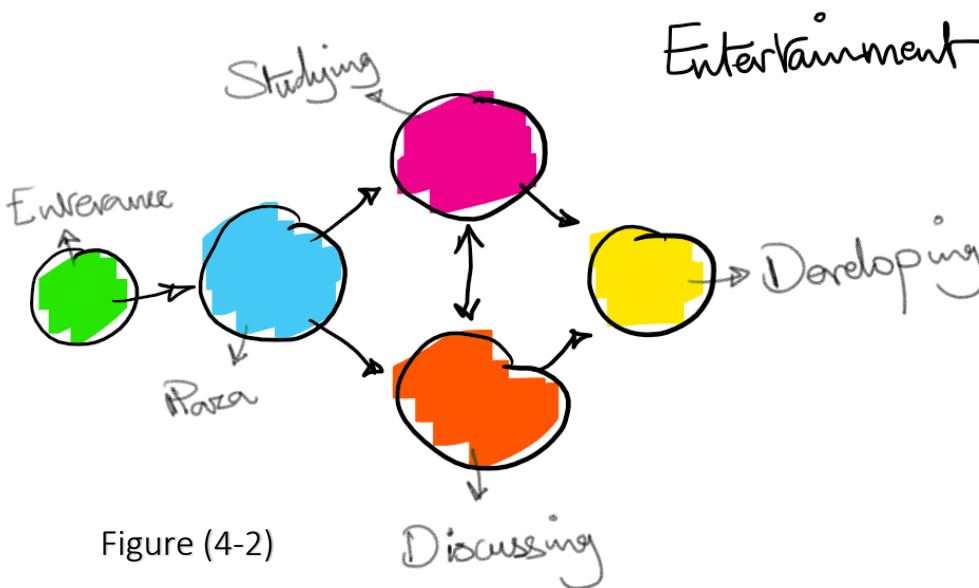

Figure (4-2)

The process of making anything begins with studying followed by discussing with other colleagues these studies and then researching and developing the results in order create or invent anything.

### 4-1 | Complex Design Concept

The journey of creating or inventing anything Begins with

Studing → Discussing → Developing

The simple journey of inventing and creating anything in the human life

Arranging the process according to the proposed zoning and have a clear view of all of the components from the eye of the visitor inside the complex environment.

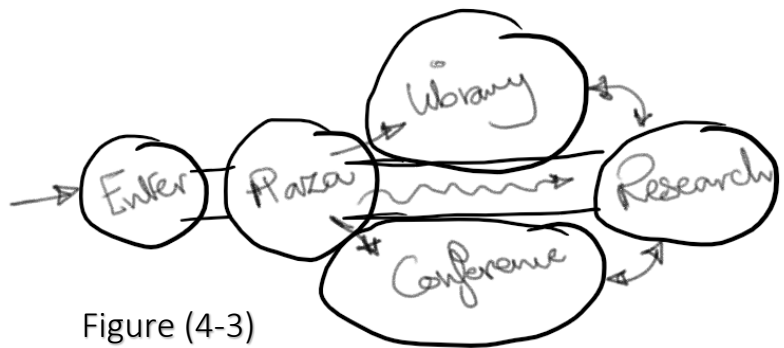

Figure (4-3)

Everything in this universe has a center or heart that do the main part of keep the wheels on moving and this is the cycle of the life of anything it keep working through this process.

So mainly the concept of the complex design was inspired from the life itself and everything in it and its nature.

Everything has a heart or centre

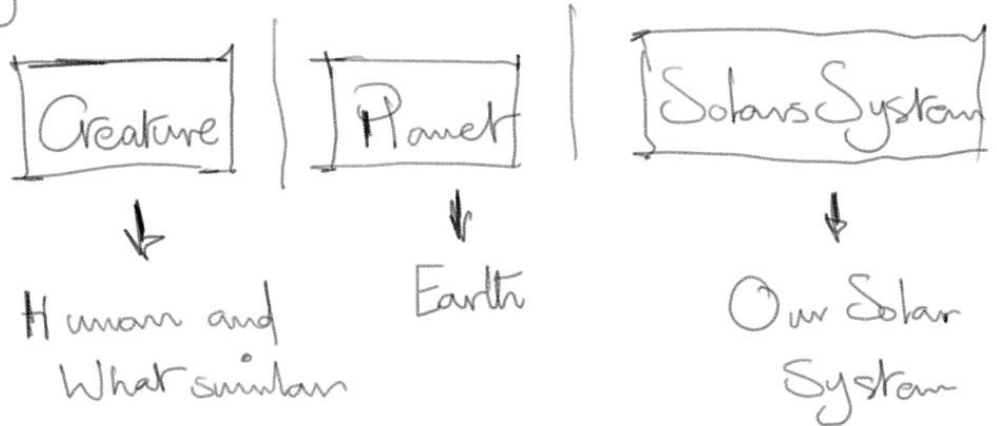
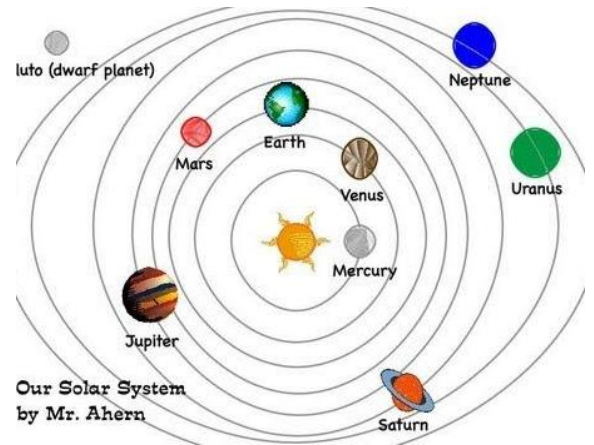
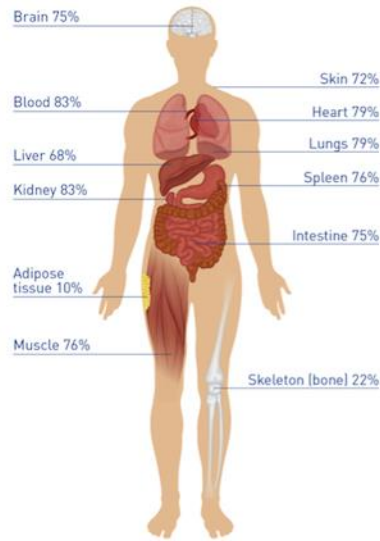

Figure (4-4)

### 4-1 | Complex Design Concept

It is a simple equation as it has been explained before.



Centre + Other Organs

Human → Heart, liver, lungs... etc

Plant → Roots, trunk, leaves... etc

KCST → library, Conference, Research...

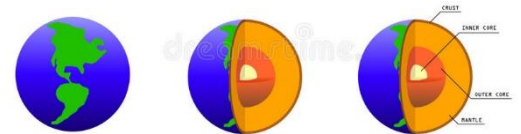

Figure (4-5)

The complex contain multiple buildings and they are all almost equal to each other in their importance but as it was mentioned, everything has a center and the center and purpose of the whole project is development and inventing. This is shaped in the research sector, which will contain the research facility and the exhibition of the products, which are invented there.

To give it this importance through architecture it has been taken as a landmark for the complex which will be supported with the other components of the complex just like the tree.

### 4-1 | Complex Design Concept

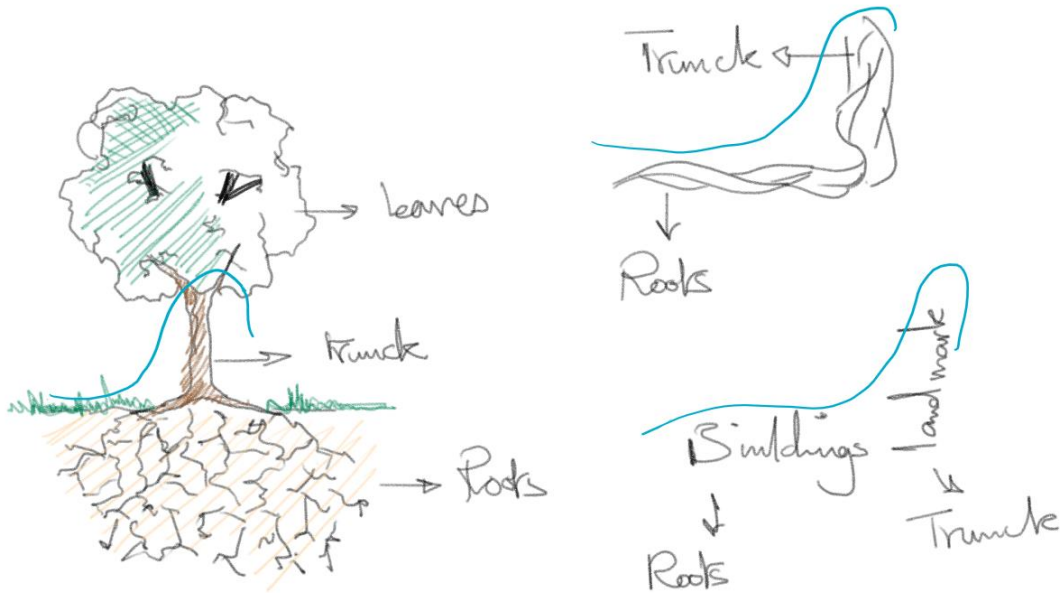

Figure (4-6)

The roots supply the tree with nutrition and support it and this is how the complex work.



Figure (4-7)

### Conceptual Elevation

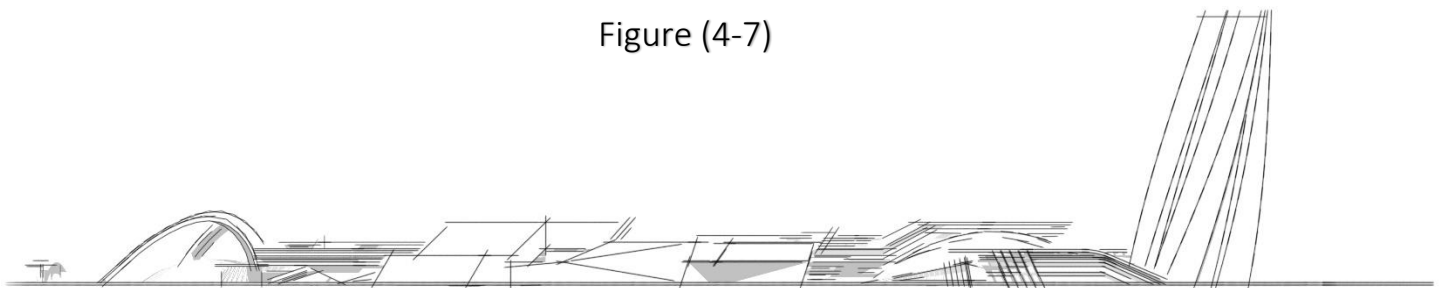

Figure (4-8)

## 4-1 | Complex Design Concept

The next figure shows a hand sketch of the site plan and the concept result as it was explained in the previous diagrams.

The site contains four buildings, the library, conference center, additional exhibitions and the research center.

The figure down below explain the sketch with the concept diagrams and the components of the site.

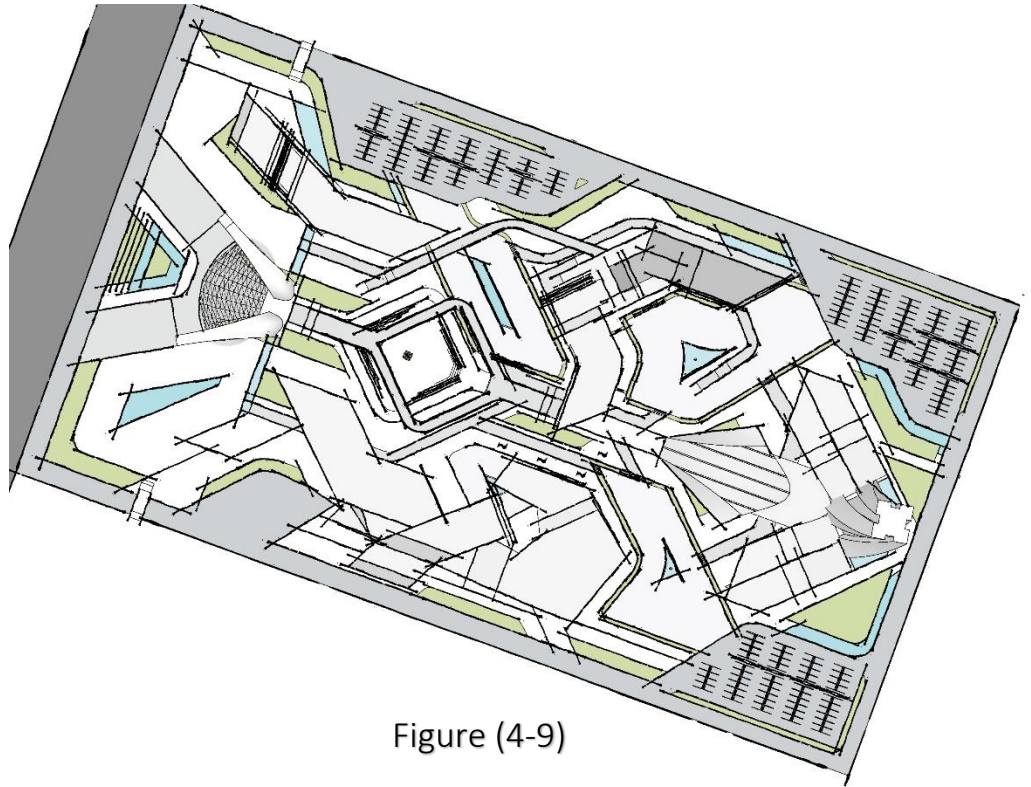

Figure (4-9)

### Site planning

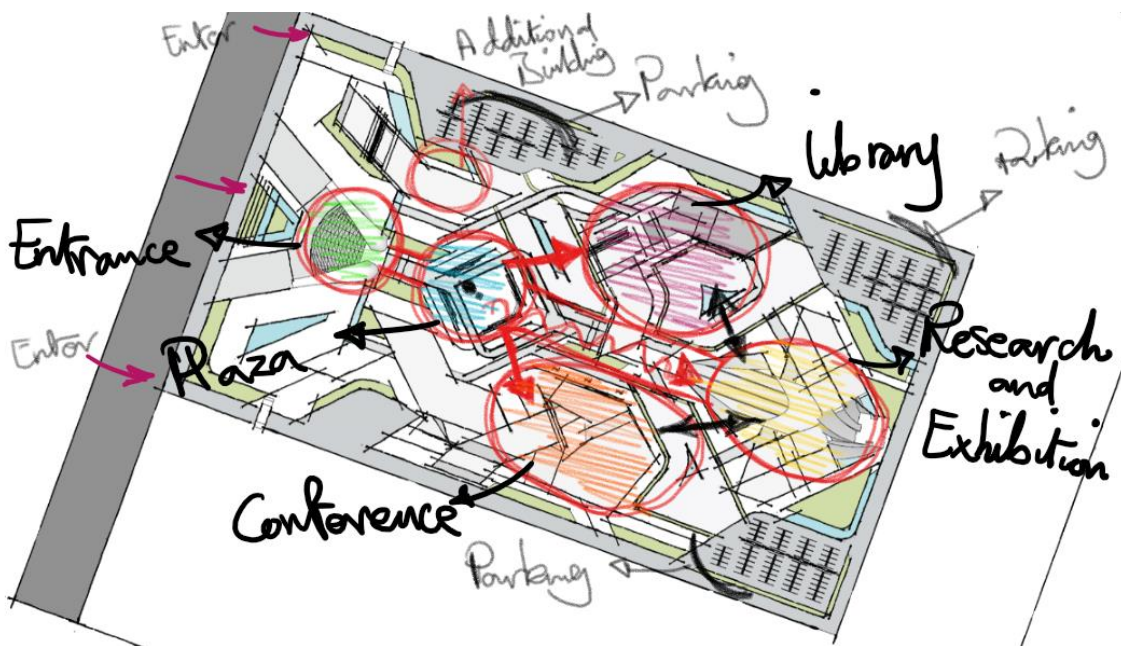

Figure (4-10)

### 4-1 | Complex Design Concept

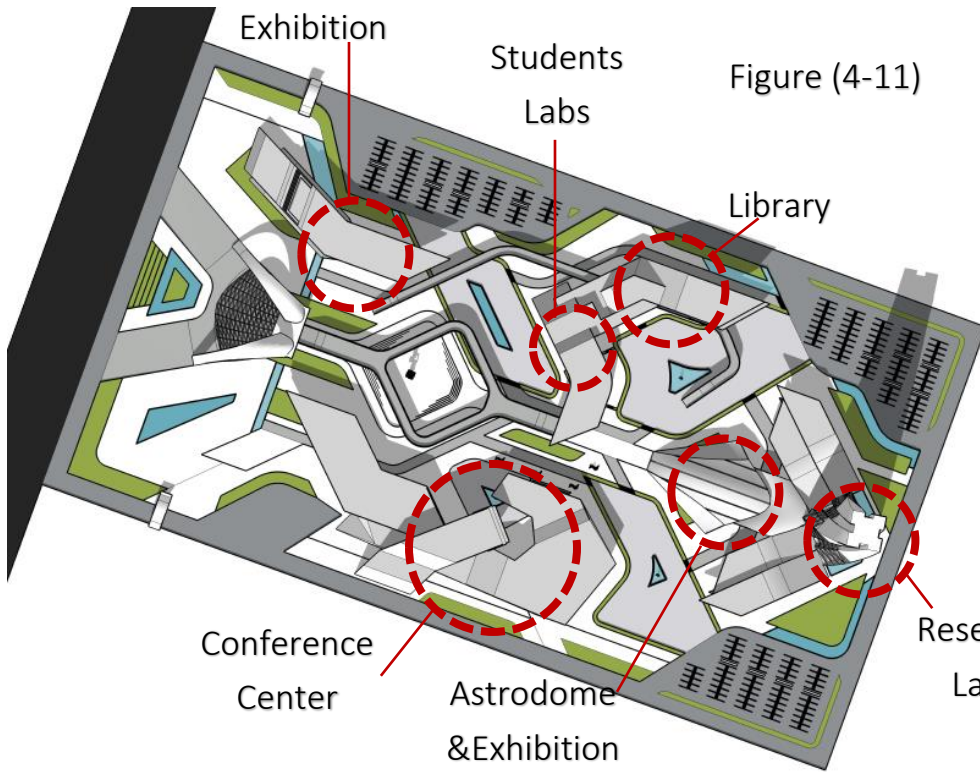
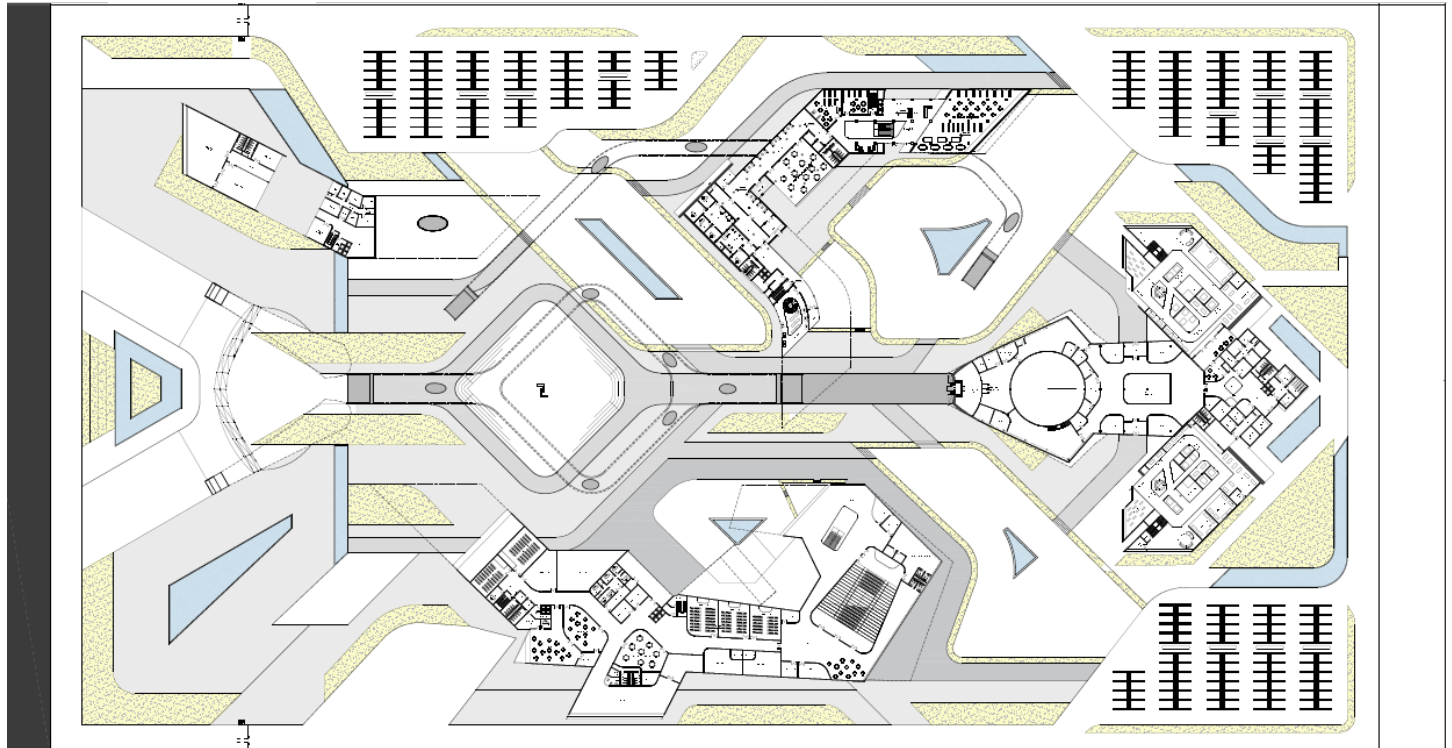

Figure (4-11)

Khartoum Complex of science and technology site plan.

The figure shows the final planning of the complex and the distribution of the buildings and the outdoor and landscape.

The next figure shows the master plan of the complex with all the buildings.



Complex Ground Floor Plan

Figure (4-12)

### 4-1 | Complex Design Concept

Figure (4-13)

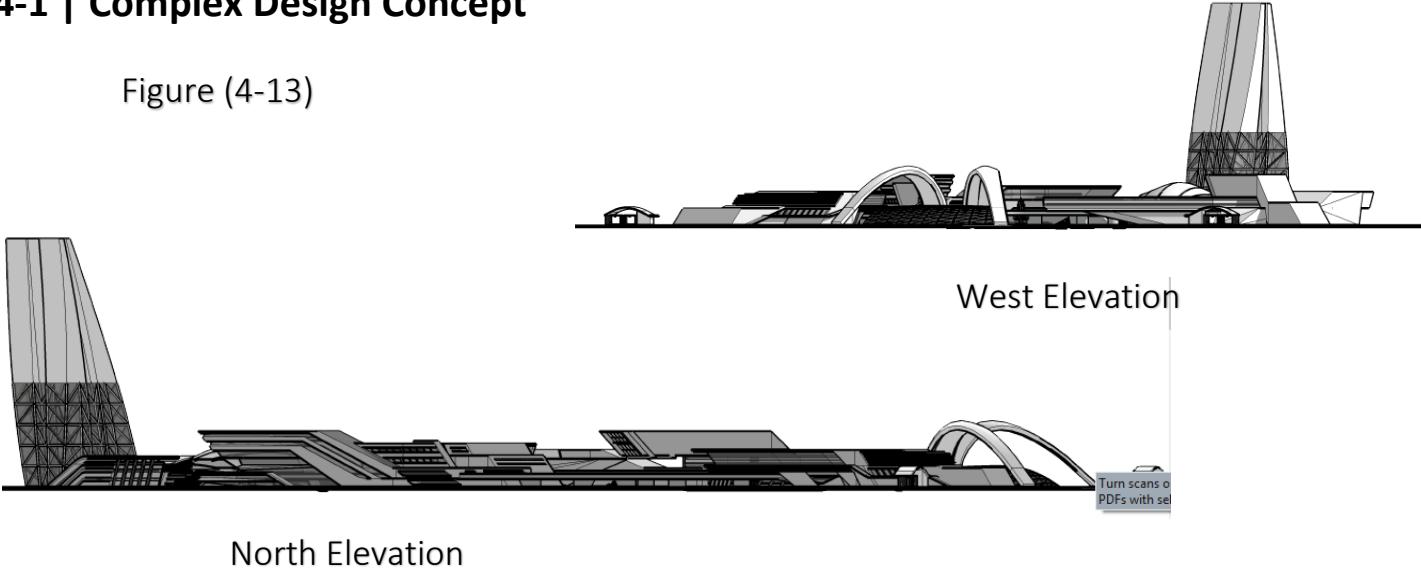

North Elevation

West Elevation

Figure (4-14)

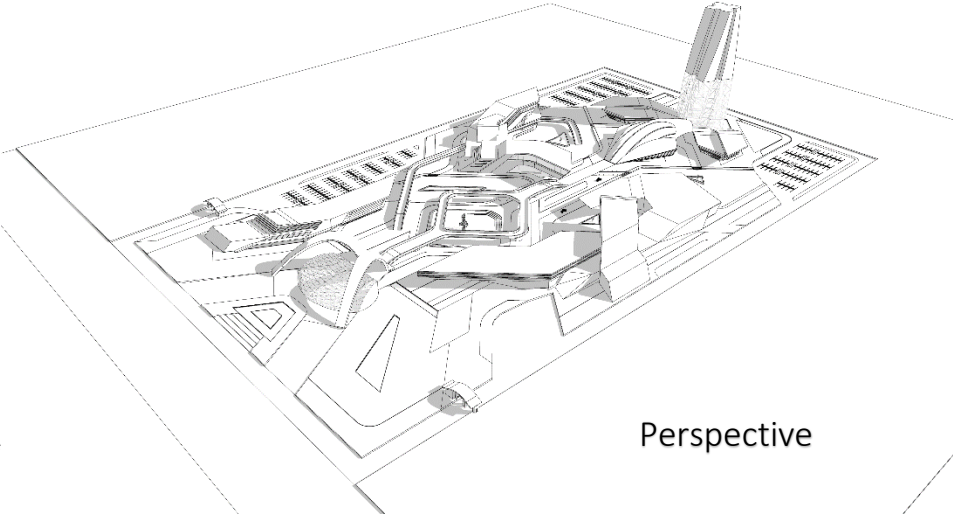

Perspective

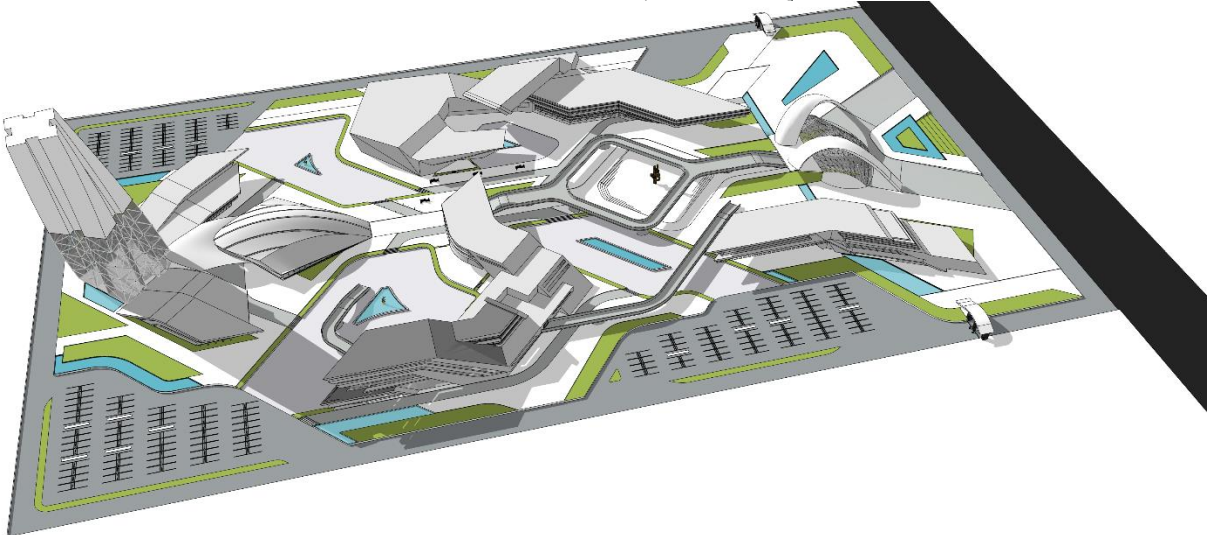



## 4-2 | Library Building Design

### 4-2-1 | Library Concept Diagrams

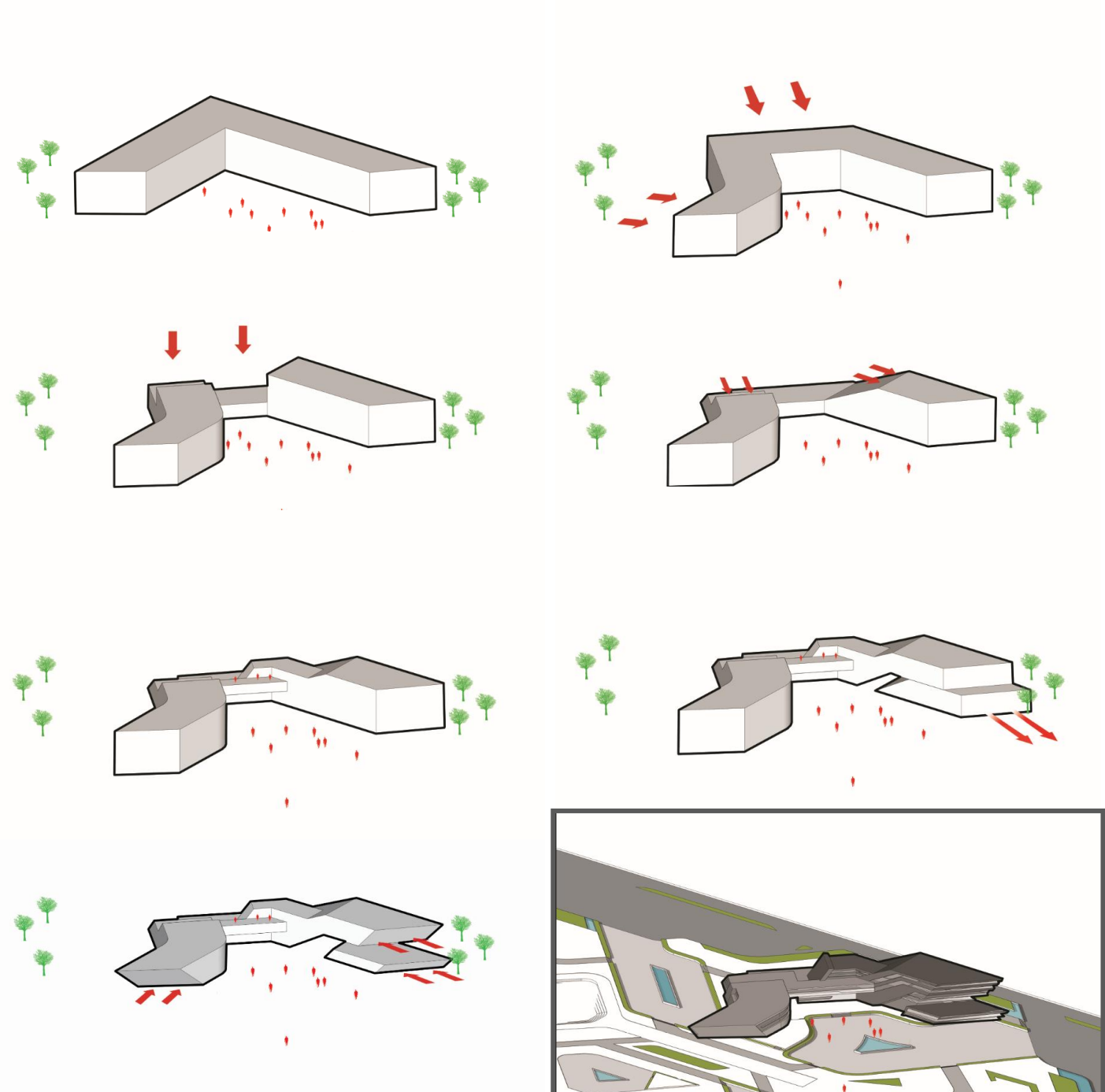
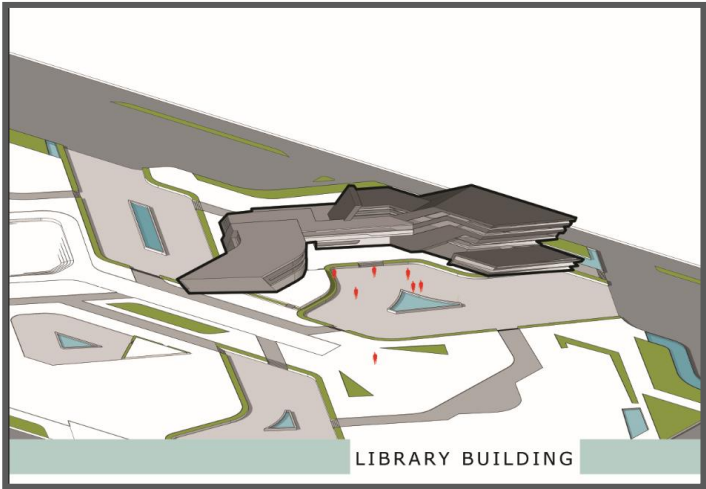

Figure (4-15)



## 4-2-2 | Library Concept Sketches

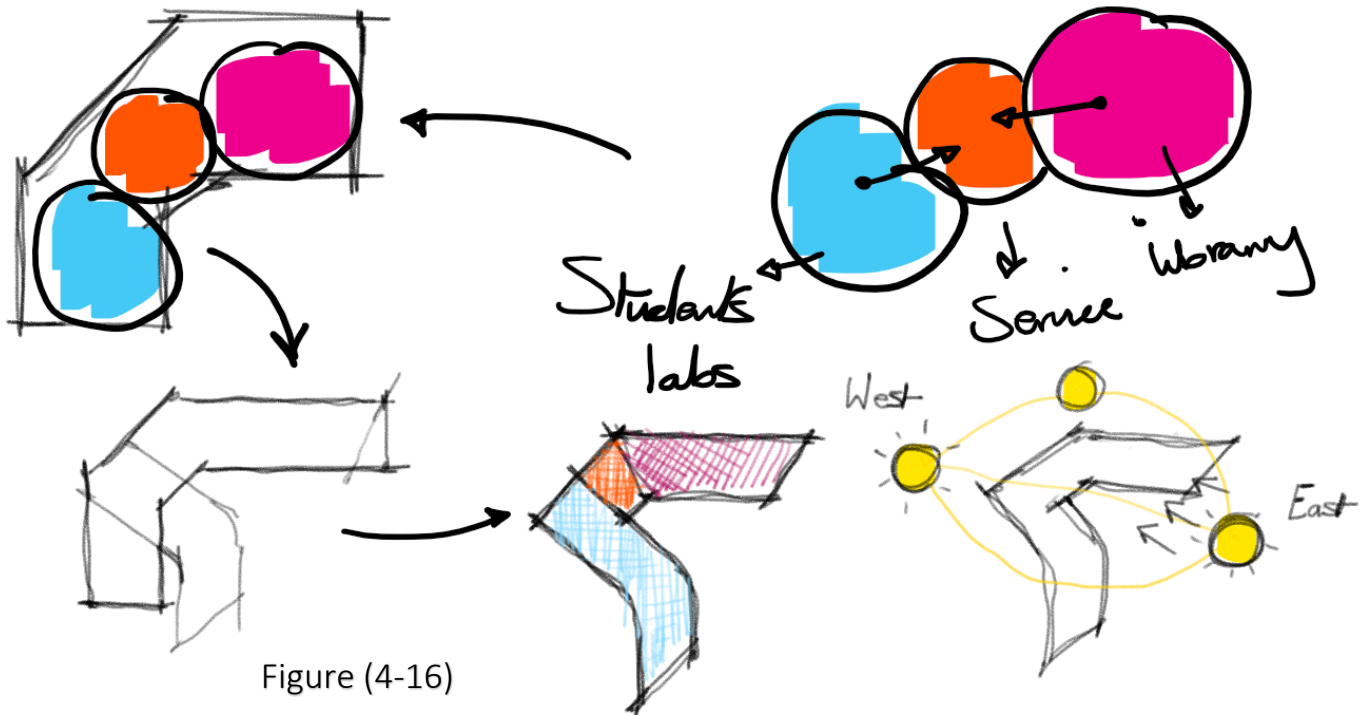

Figure (4-16)

### Brief

The library building is divided into three main zones, which shaped the form, and they are the reading and library zone, Public service area and the student labs.

The develop of the concept main depended on giving the library area as much natural light as possible and minimizing the amount of the day light for the other used zones. To the building the feel of welcoming and containing, it was angled at the fronting plaza which is attached to it.

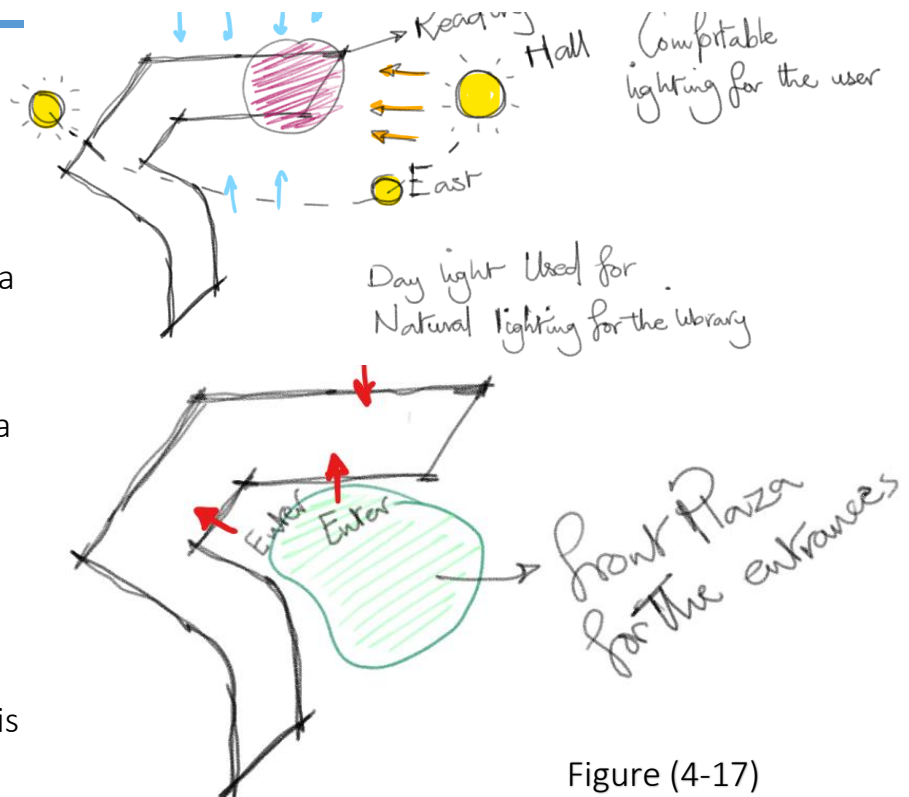
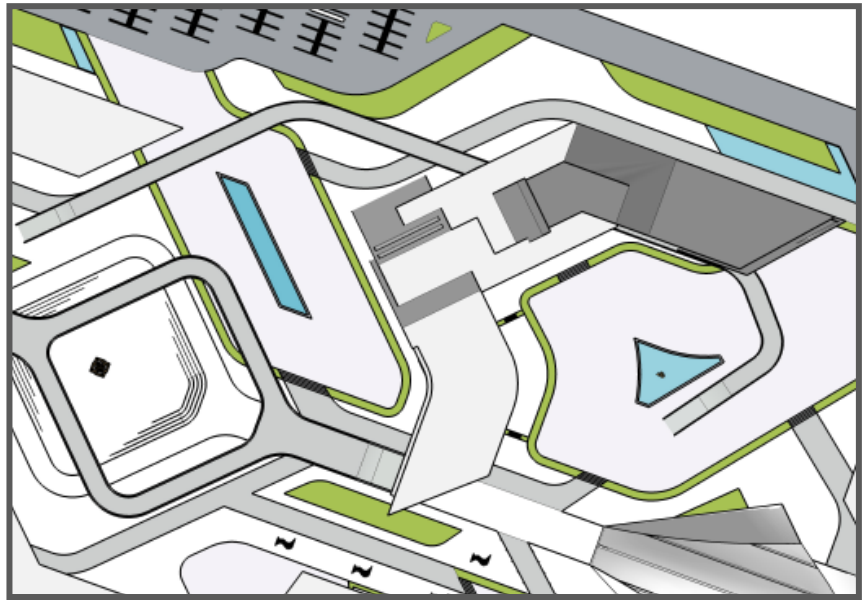

Figure (4-17)

### 4-2-3 | Library Design

The next figures show the architectural drawing set of the library building from plans, section to views

Figure (4-18)



Site Plan

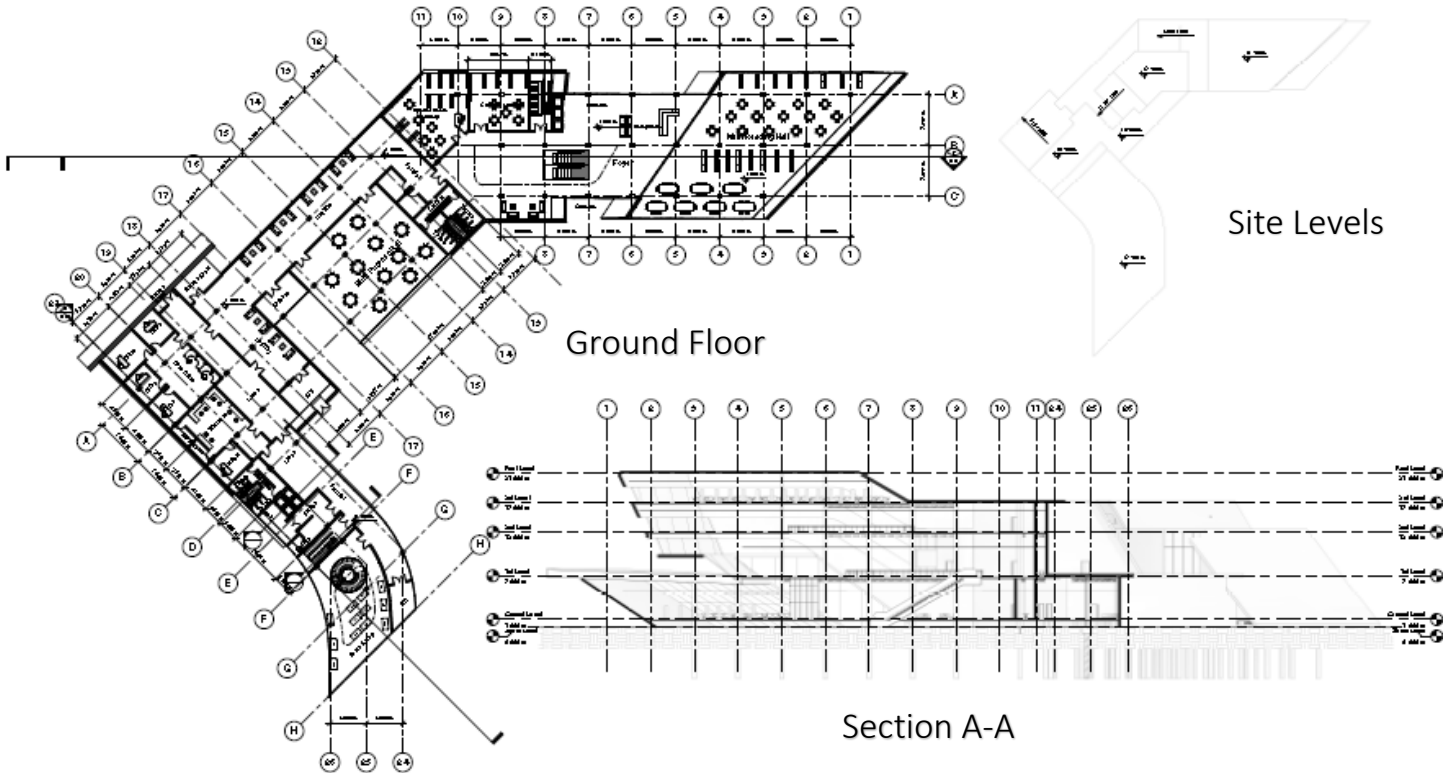
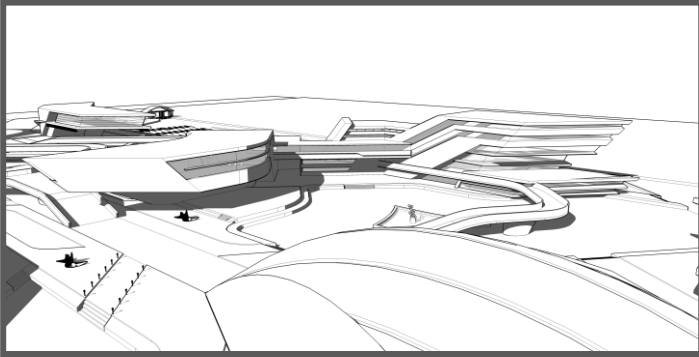
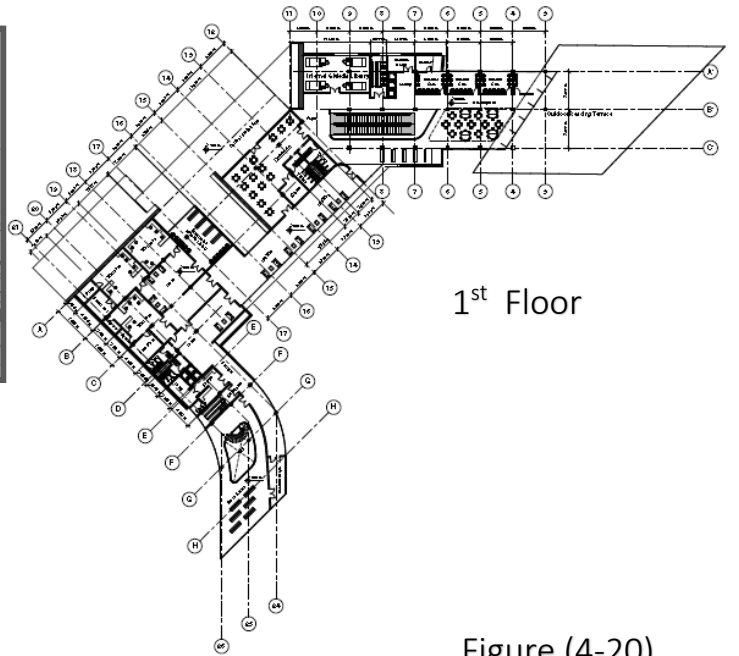

Figure (4-19)

4-2-3 | Library Design



Perspective View



1<sup>st</sup> Floor

Figure (4-20)

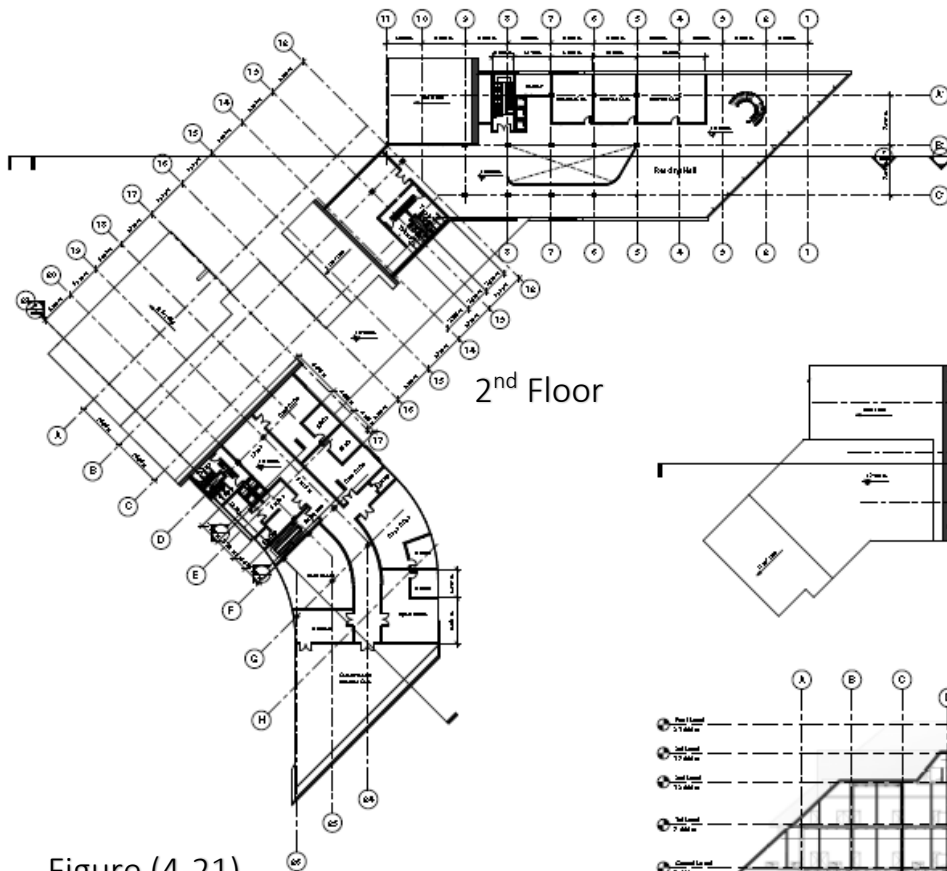

2<sup>nd</sup> Floor

Figure (4-21)

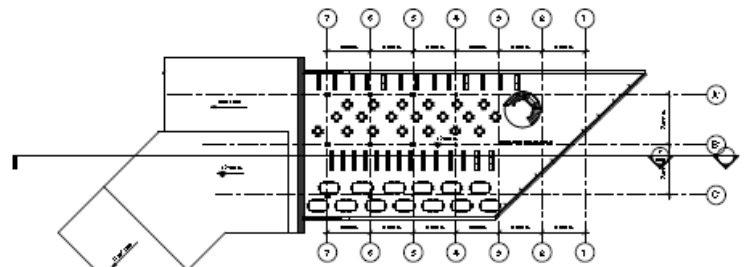

3<sup>rd</sup> Floor

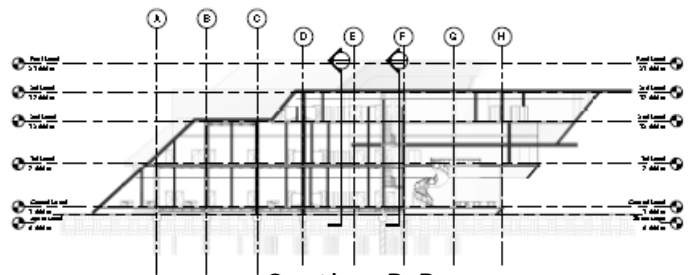

Section B-B

### 4-3 | Conference Center Building Design

#### 4-3-1 | Conference Center Concept Sketches

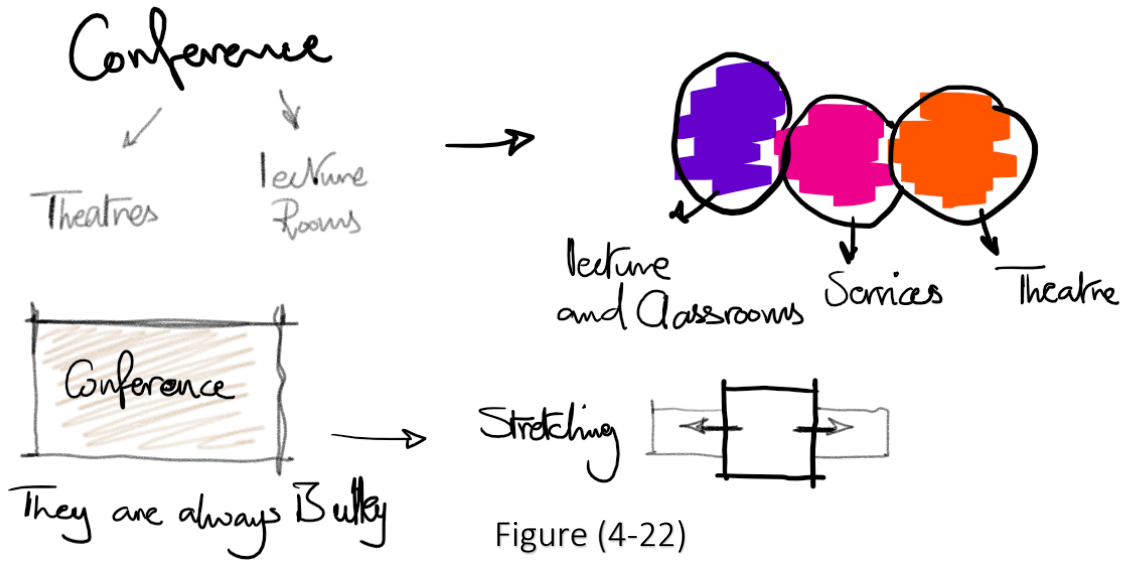

The design of the conference halls and theatres are always referred to be bulky, which suits the nature of the function, but in this situation looking at the fact it will be located as one of the buildings in the complex. This will give the feeling of crowdedness, this why the volume has been stretched a little to be linear and then angled the volume to break the feel of long corridors.

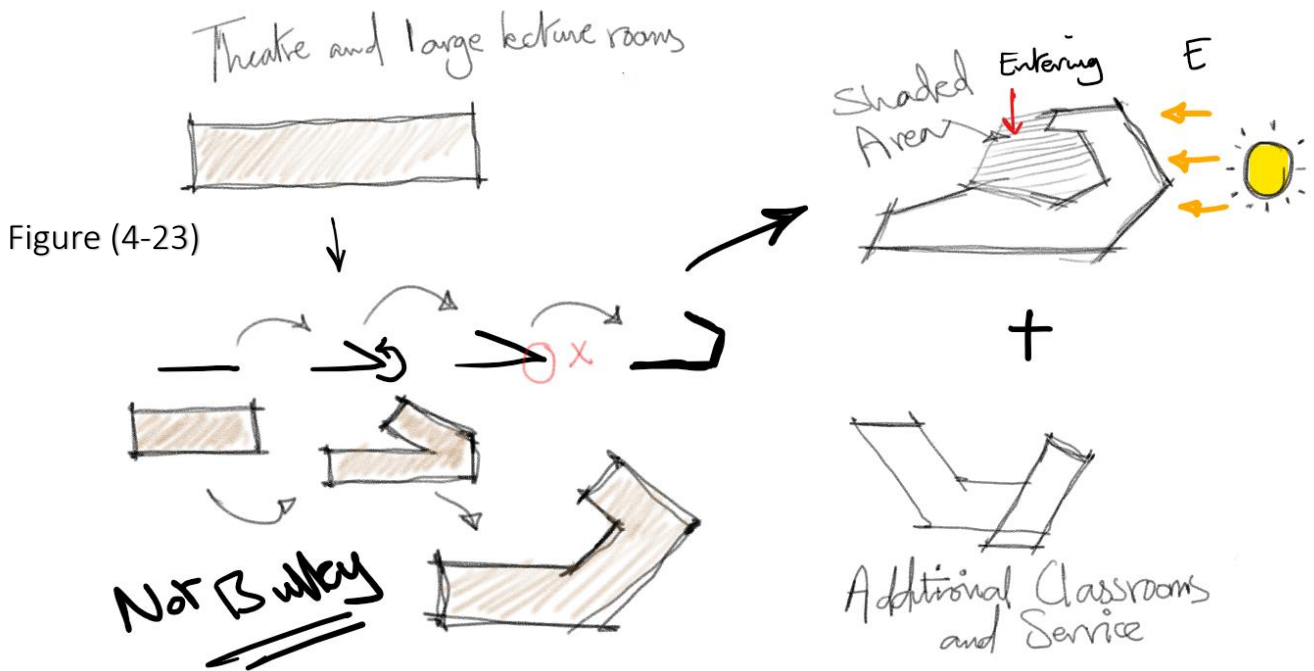

### 4-3 | Conference Center Concept Sketches

Shaping the volume in this way added some shade to the front yard of the main reception of the building. The reason behind manipulating the shape of the volume in this way with these strange parts and geometry is to create an out of the ordinary building to the eye of the person, the user, the one who will experience and live in this environment.

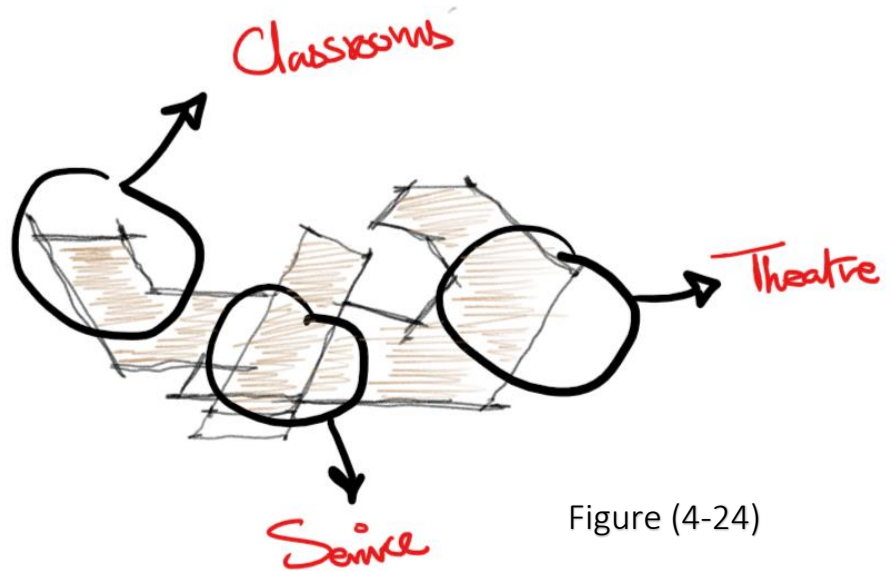

Figure (4-24)

The geometry contains abnormal cantilever and surfaces that will be amusing to the eye and makes the mind wonder how it was constructed.

The design does not affect the nature of the spaces inside the volume in anyway.

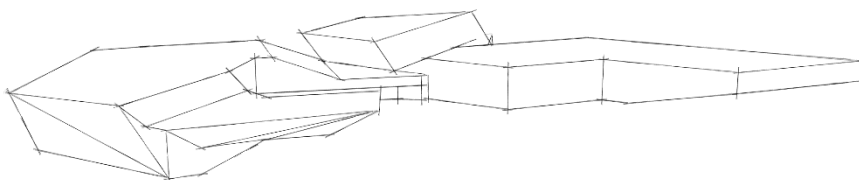
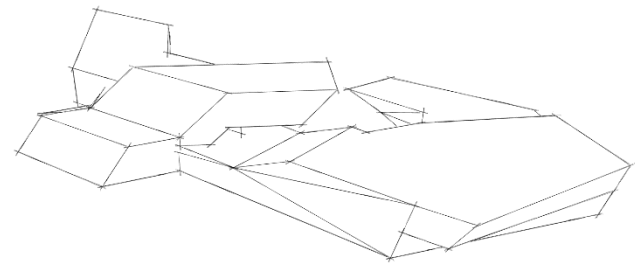
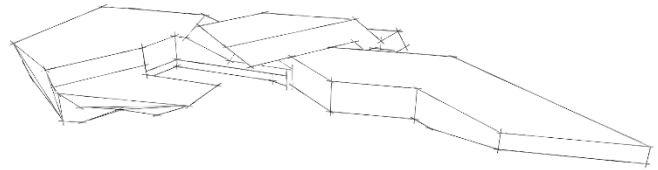
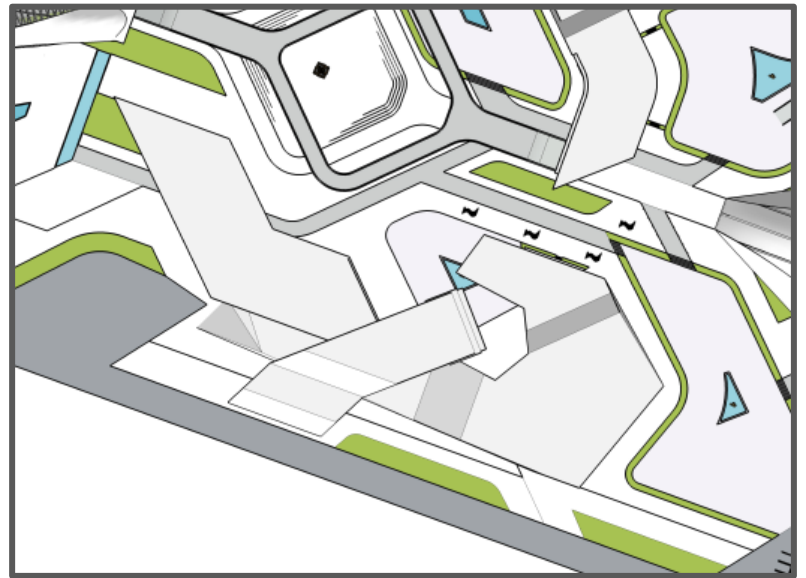

Figure (4-25)

### 4-3 | Conference Center Building Design

The next figures show the architectural drawing set of the Conference building from plans, section to views

Figure (4-26)



Site Plan

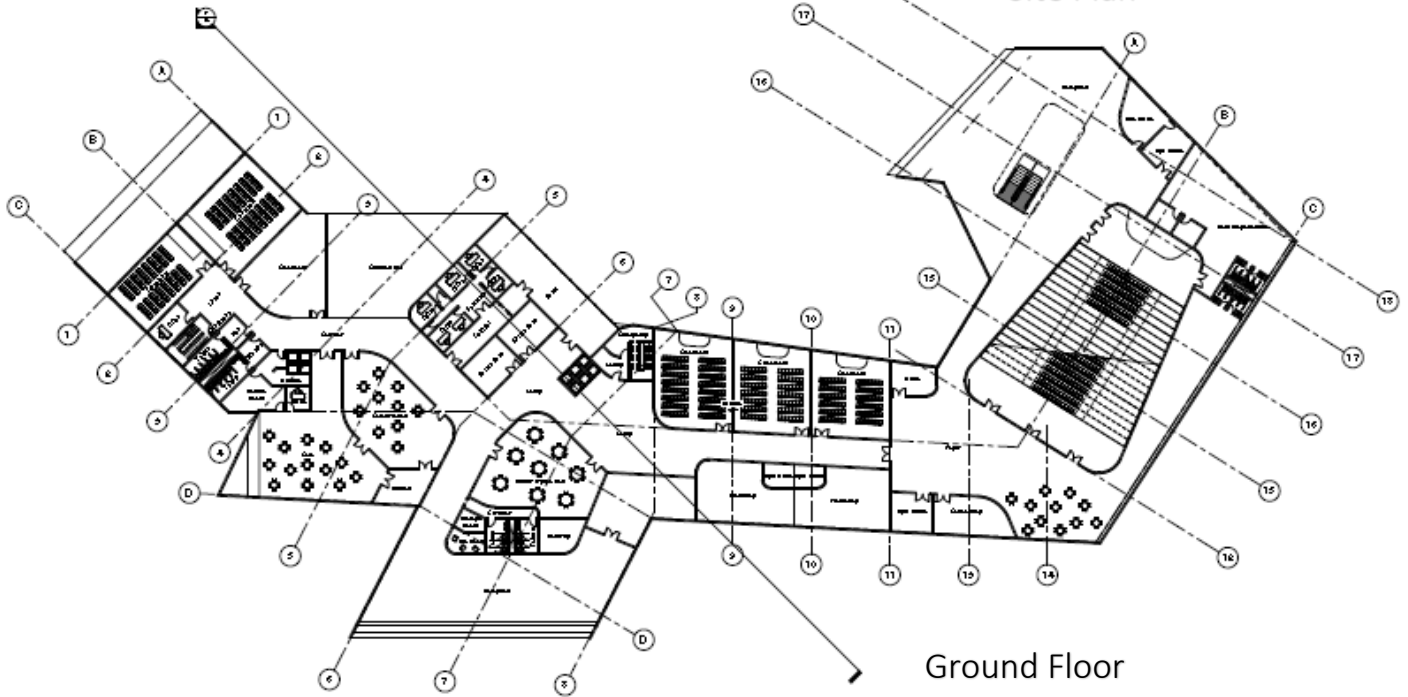

Ground Floor

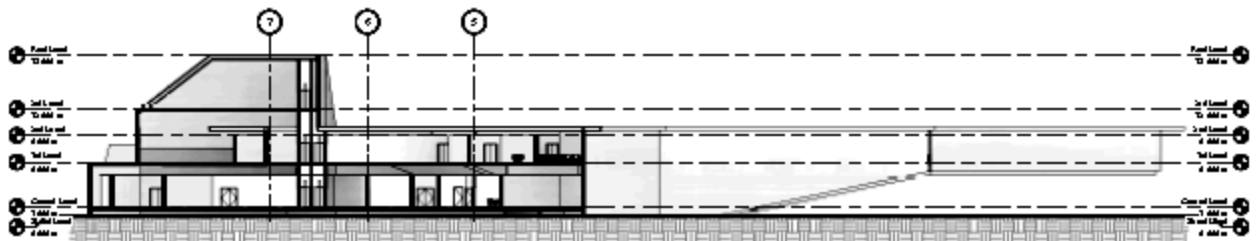

Figure (4-27)

Section

### 4-3 | Conference Center Building Design

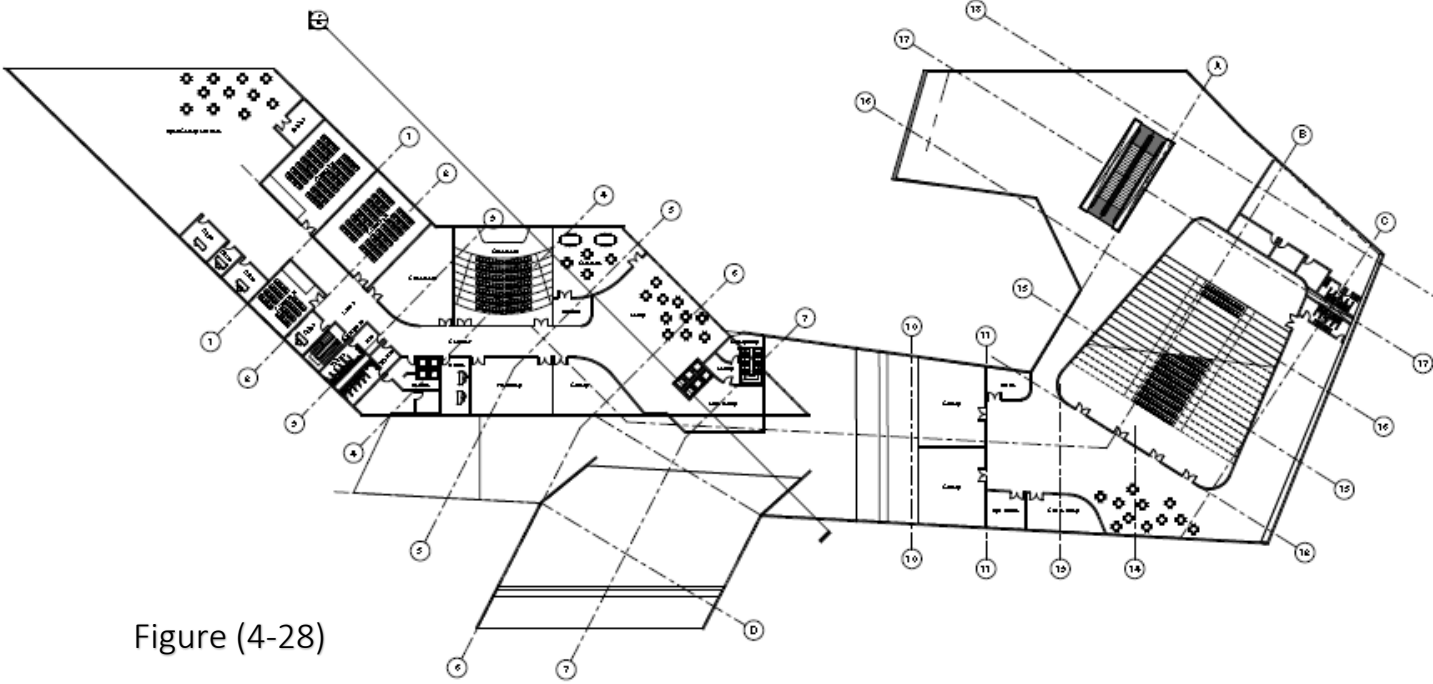
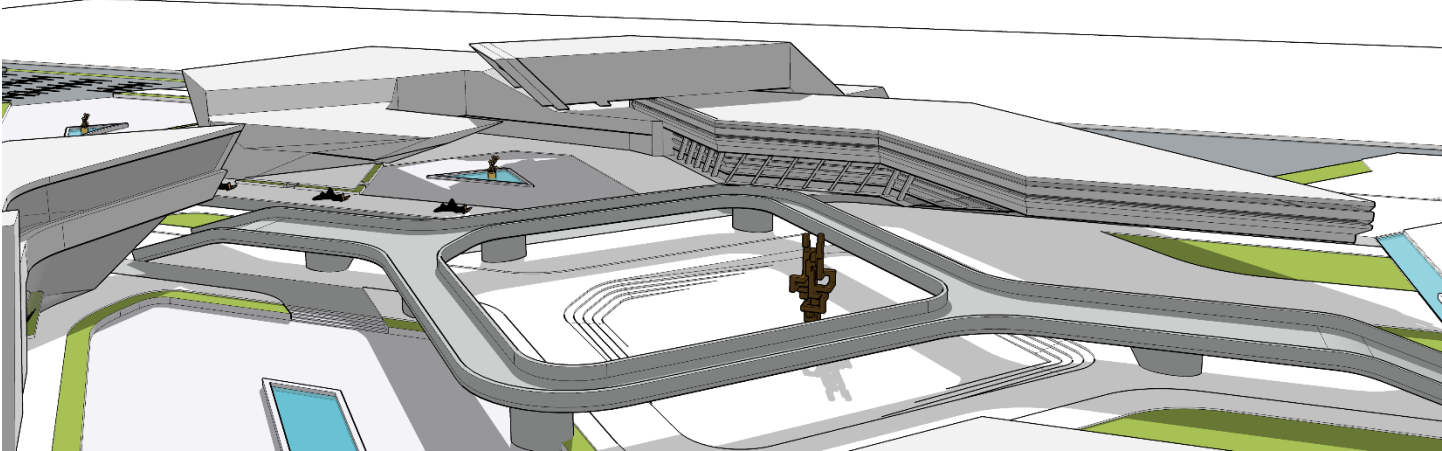

Figure (4-28)





#### 4-4 | Research Labs & Astrodome Design

The next figures show the architectural drawing set of the Conference building from plans, section to views.

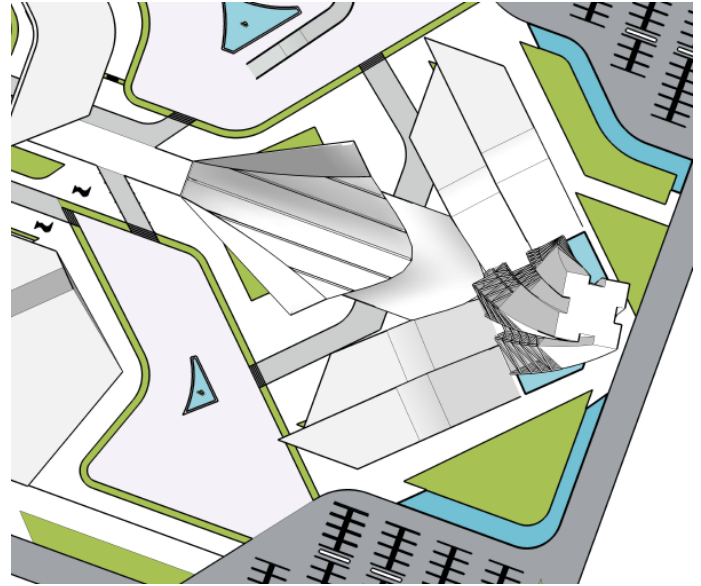

Site Plan

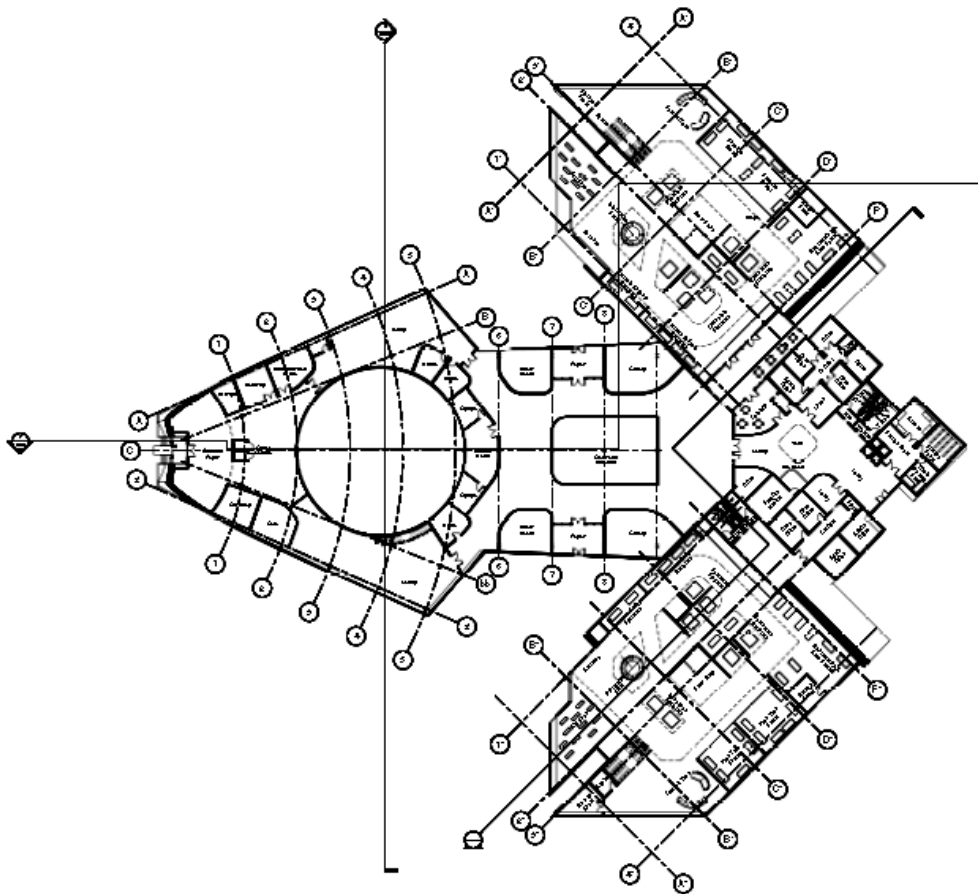

Ground Floor Plan

### 4-3 | Research Labs & astrodome Design

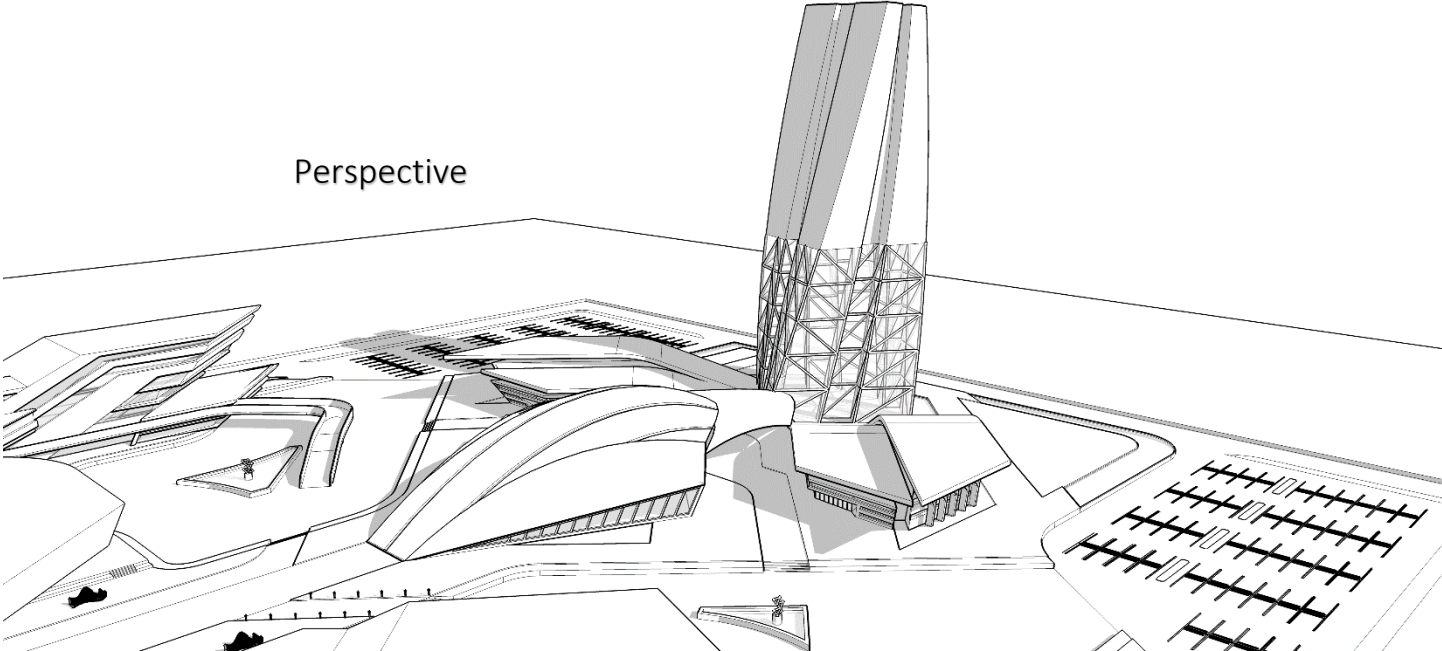
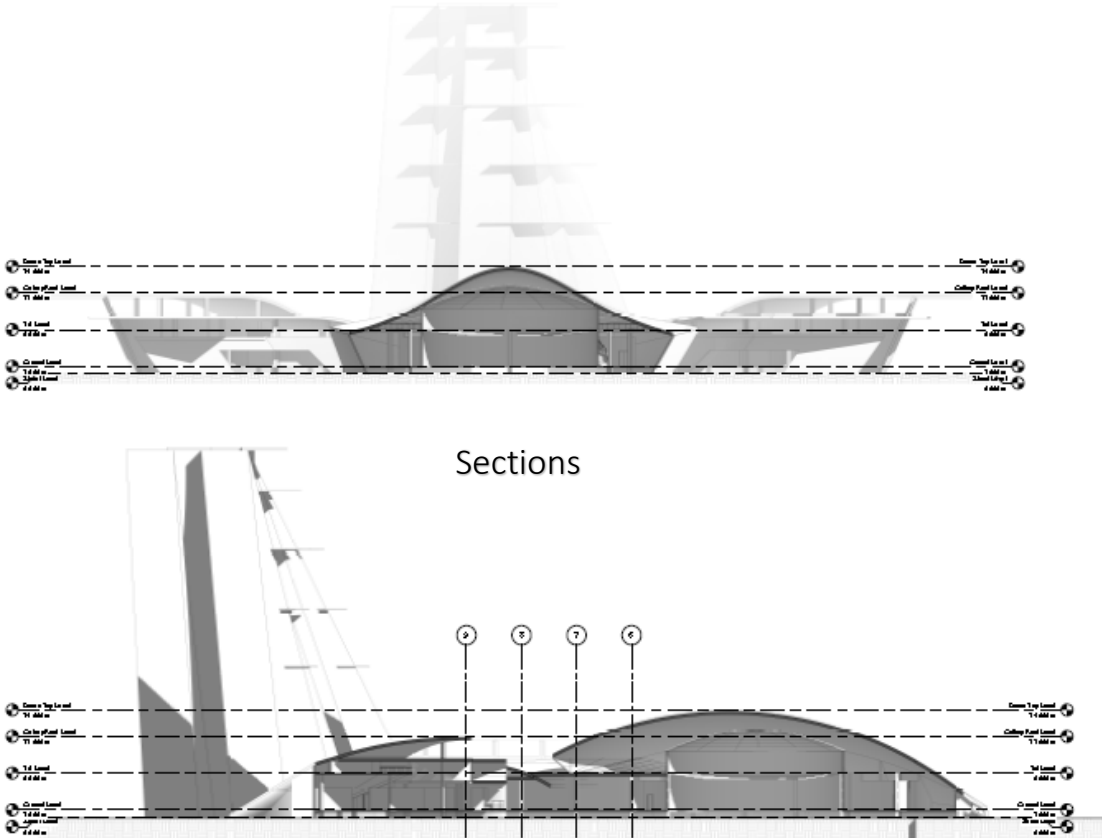

# Khartoum Complex of Science and Technology

K C S T

## Chapter Five

*Structure and technical solutions*



## Structural and Technical Solutions

In this chapter the whole project will be previewed for the general technical solutions that are proposed and then the library and student labs will be taken as a scope of work looking at the similarities between the building in general in the technical solutions.

### 5-1 | Structural System

The design of the buildings in the complex Contains a bit unusual shapes and volumes from the ordinary due to that, most of the building structure is steel, looking at the non-usual volumes and masses from large interior spans to the existing of long cantilevers.

So mainly, there are couple of main structure systems, and then there are some part of the buildings that contains some special details.

#### 5-1-1 | the structural foundations

The pier and beam foundation is the most suitable to use looking at the location of the site property near the White Nile Bank and the clay soil properties which makes the ground unstable to use raft foundation. Figure (5-1).

The foundation must be isolated so any water or so do not affect it.

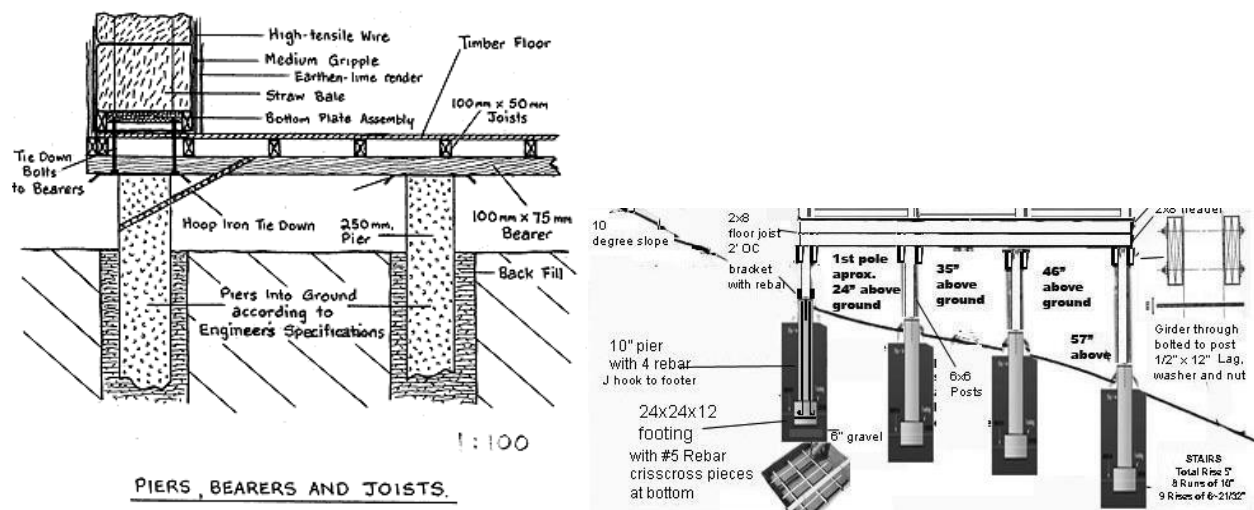

Figure (5-1)

### 5-1-2 | Structural columns

The proposed structural columns are the steel universal I section columns, for its ability to handle large long spans, which are considered and used in this type of buildings (exhibition & Galleries). Moreover, they are easier to connect to the steel flooring. Figure (5-2).

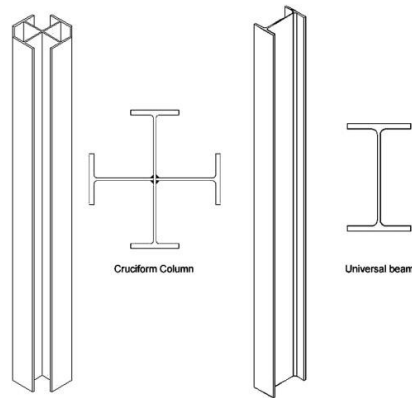

Figure (5-2)

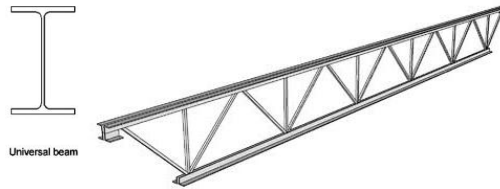

Figure (5-3)

### 5-1-3 | Structural Floors

The floors of the building are loaded over primary open web steel joist beams, which give long spans, and are supported with universal I section beam. Figure (5-3) & (5-4).

One of the advantages, it is easier to construct any type of HVAC ducts or electrical wires and any pipes that are need for the services of the building. Figure (5-4).

As for the floor deck, the ribbed steel decking is used which reduce the overall depth that gives a lighter floor weight. Figure (5-5).

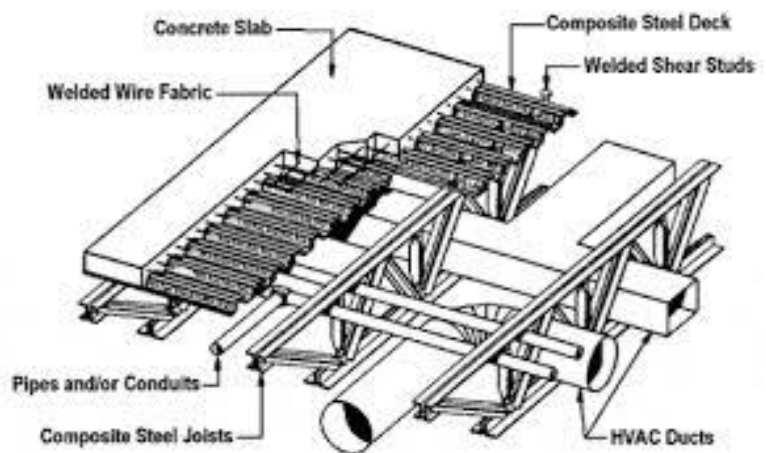
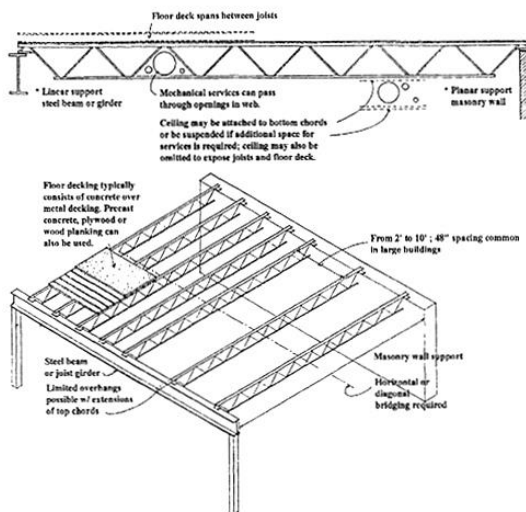

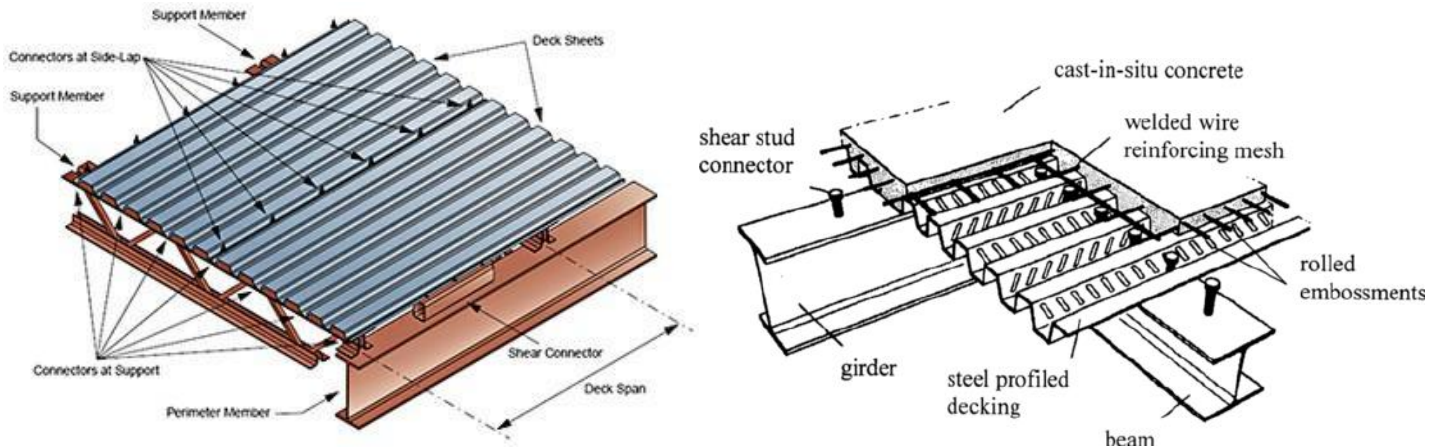

Figure (5-5)

### 5-1-4 | Roof Structure

The main exterior roof structure is a complex form of spaceframe, which now, is commonly used in modern organic and deconstruction architecture.

In addition, it is preferred in this project looking at the concept design of volumes. Figure (5-6).

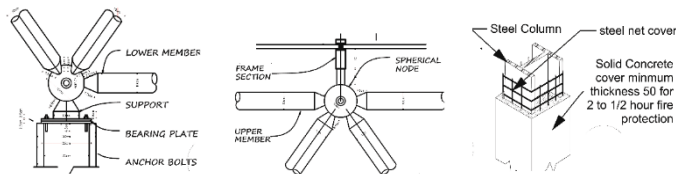
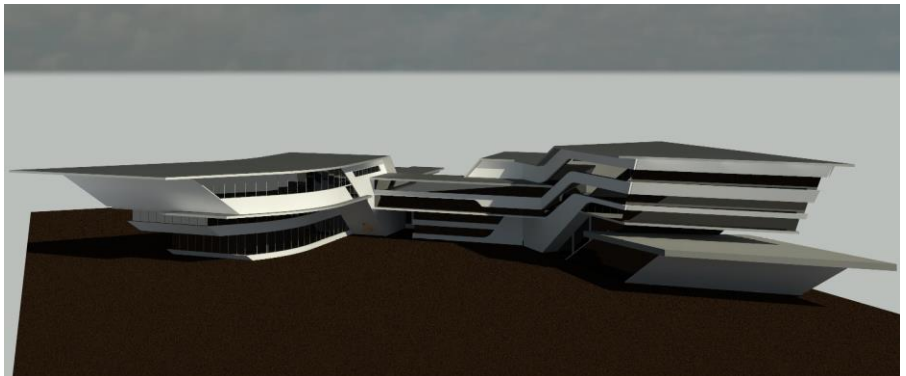

Figure (5-6)

### 5-1-5 Expansion joints

The building is considered long that it need expansion joints at some of its parts to prevent any collapse at any rate.

The figure below show the library building and its volume shape and the next figures will show the structural plan and the 3D of the structure and an exploded axonometric view for it.



## 5-1-6 | 3D structure Model

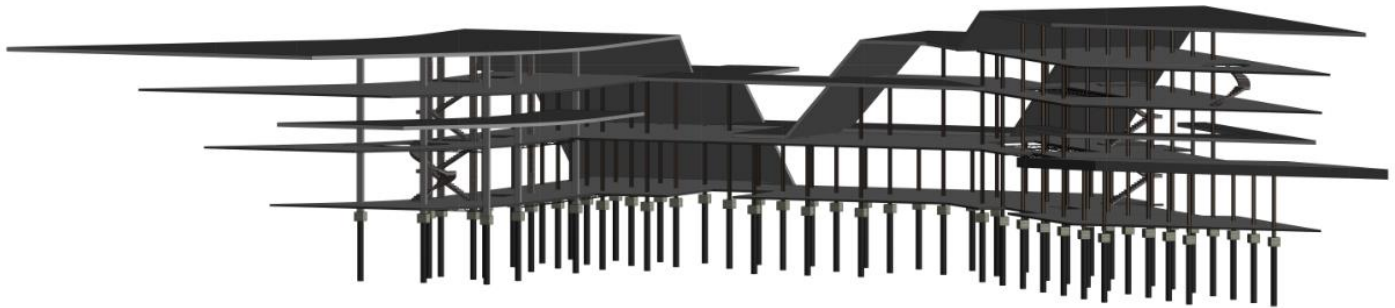

### Exploded Axonometric

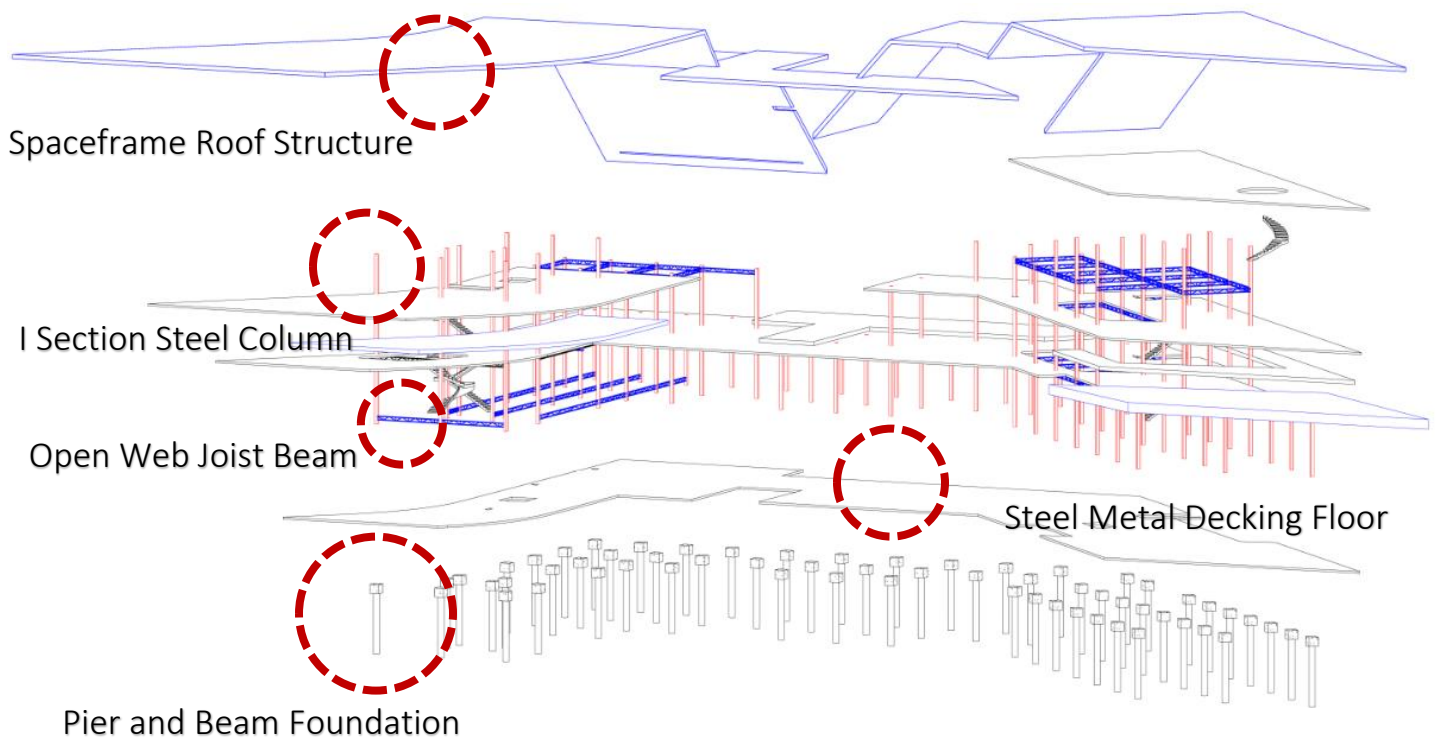

The figures above show the structural elements of the building from foundation, columns, and floors to roof.

## 5-2 | *Finishing Solutions*

- The project outdoor and landscape contains different parts, levels and components, so the determination of finishes will depend on the function and use of the sector.

- **Asphalt** (for the parking).

- **Brick pavement** (in the pathways and corridors). Bricks were chosen because it can handle the different weather elements and the friction caused by the high number of users in the project. Figure (5-7)
- **Cement tiles** (in the slab around the buildings). Figure (5-8)
- **Grass.**
- **Trees** to supply the needed shade and shadow for the project.
- **Fountains** and water elements.
- **Composite slabs** (in the buildings of the project) which consists of White concrete layer, c/s mortar, 3 insulation layers of D.P.C., zinc sheet, steel beams.
- **Aluminum sheets** (in the cultural building) which has the following layers beneath it: Insulation layer, Air space, Insulation layer, steel purlins, steel beams, portal frame girder, steel purlins and beams, aluminum frame for the false ceiling, false ceiling elements 60cmx60cm.

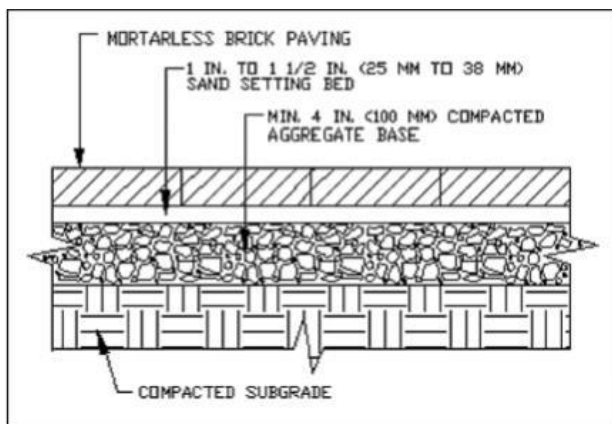

Figure (5-7)

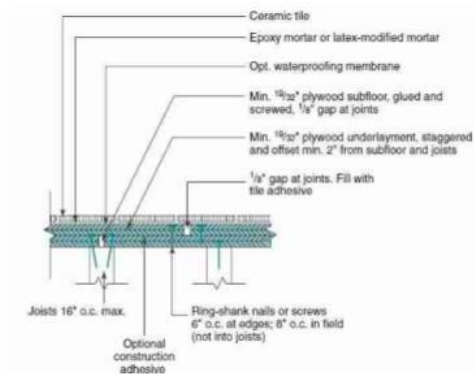

Figure (5-8)

## Interior Finishing includes the floors, walls and ceiling.

### Floors

- Porcelain tiles 90cmx90cm in the main corridors and in the receptions.
- Carpet in some of the offices to reduce the noise in these spaces.
- Wooden floors in the production offices & meeting rooms to give the luxurious look.

### Walls

- White paint with some stripes of other colors to motivate the designers and inspire them more.
- For the studios, gypsum isolation walls were used.



### Ceilings

- Gipsom board false ceiling 60cmx60cm.
- White paint with some colored stripes.



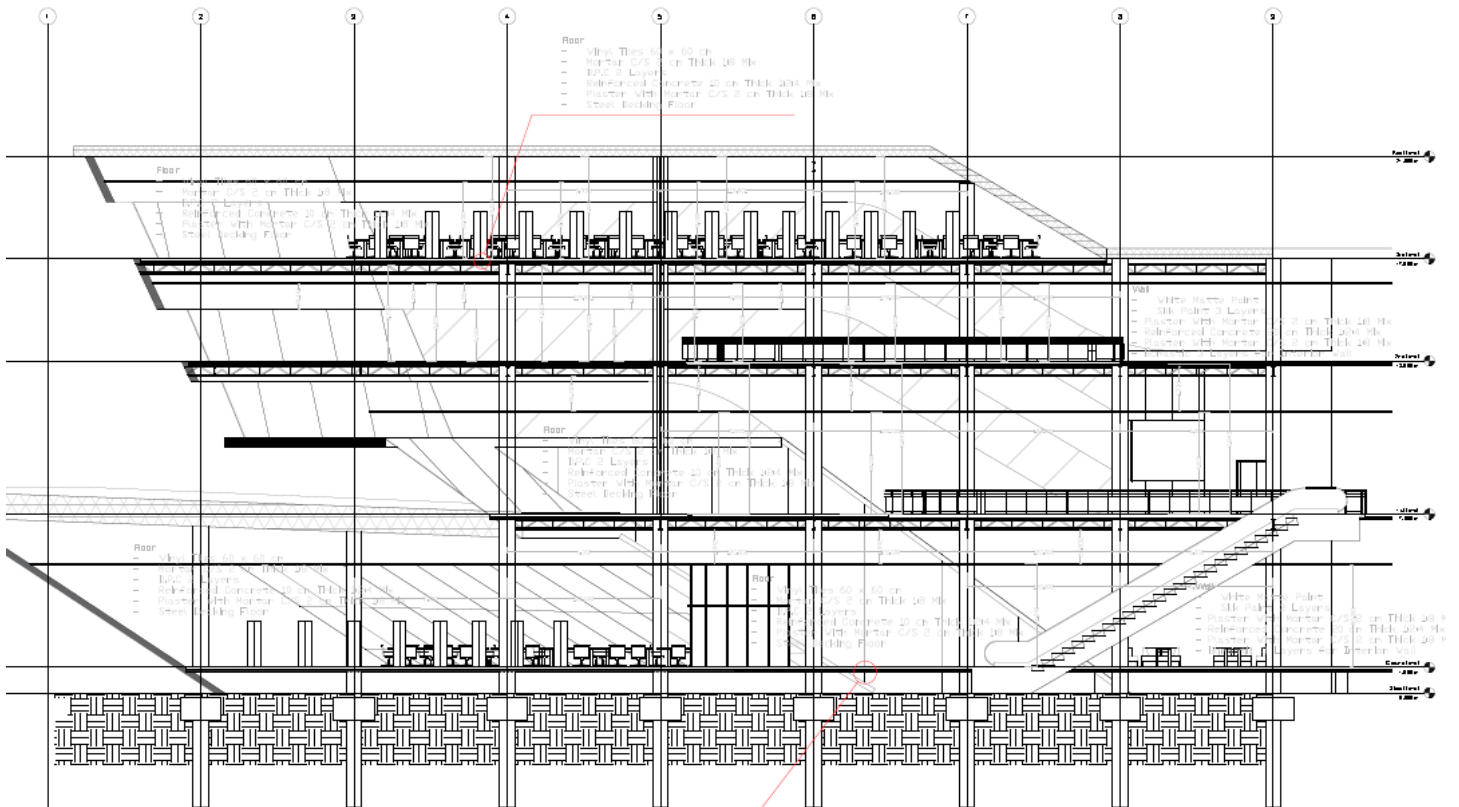

### 5-3| Site Electrical Supply

The electrical supply is from the main Omdurman city electrical grid, it enters the site from the western side of the property with a voltage of 33,000 volt and then to the main transformer that transform it to 11,000 Volt, to 3,000 volt and then to 415 volt.

The wires are connected to the main control room of the site, which are distributed after that to the main control boards of each building in the site through ground wire system.

#### Cables and Conductors

Isolated cables are used in order to supply the building from the city electrical grid. The cables will be in trenches at a proper depth. As for the conductors in the building, they are put in pipes, which are mounted in walls and floors.

#### Main Supply Circuit

It works with an automatic system that runs in case of the public electrical grid went off, and the generators usually are replaced in the basement of the building.

## Lighting System

Taking an advantage of the sun and the property of the country the outdoor landscape will use the solar lights with ground batteries that charge during the day and work at night, and the exteriors of the building will use spotlights and LEDs.



## 5-4 | *Water supply*

Looking at the public network, and the low pressure that is provided by it, the used system is the indirect supplying system, which use an underground water tank and a roof cistern.

The acquired quantity of water = Daily water use + Fire protection water.

Daily water use = Daily water use per person + Landscape water use.

The daily use of water depends on the building function and the number of users within the building, which can be taken from the analysis and project study.

Building purpose	Storage/person/24 hrs	
Boarding school	90 litres	
Day school	30	
Department store with canteen	45	(3)
Department store without canteen	40	(3)
Dwellings	90	(1)
Factory with canteen	45	
Factory without canteen	40	
Hostel	90	
Hotel	135	(2) (3)
Medical accommodation	115	
Office with canteen	45	
Office without canteen	40	
Public toilets	15	
Restaurant	7 per meal	

The selected building is the library and the tech workshops building which serve 550 User and the number of the minimum quantity of water per person per day in gallons = 12.

Which means:  $650 \times 12 = 7,800$  gallons   $7,800 \times 3.8 = 29,640$  Liters/day.

Opening hours are 10 hours, which mean the daily use of gallons is 12,350 Liter.

The landscape is excluded.

The capacity calculations depends on the user's use, which depends on the disruption of water current from the public network, which about %25 - %100.

*Disruption of water current* is 8 hours on average

The daily use =  $12,350 \times \%33 = 4,075.5$  Liters

Cistern capacity =  $12,350 + 4,075.5 = 16,425.5$  Liters

Tank Capacity (Litres)	Tank Capacity (Gallons)	External Diameter (mm)	External Height (mm)	Site/Hole Diameter (mm)
5,400	1,200	2,000	2,450	4,000
13,500	3,000	3,250	2,400	5,250
22,500	5,000	3,900	2,250	5,900
27,000	6,000	4,300	2,550	6,300
34,000	7,500	5,100	2,400	7,100
45,000	10,000	5,700	2,250	7,700
52,000	11,500	5,750	2,550	7,750
95,000	21,000	7,800	2,550	9,800
144,000	32,000	9,500	2,550	11,500
400,000	90,000	15,600	2,650	17,600
500,000	111,000	15,700	3,050	17,700
600,000	133,000	15,700	3,600	17,700
700,000	155,000	15,700	4,200	17,700

As standards in libraries and workshop the sanitary appliance are:

- 3 toilets for every 60 males and 1 toilet for every 40 females
- 1 handwashing sink for every 60 males and 1 for every 40 females
- The toilet pipe is 4 inches diameter S shape for the ground floor toilets and P For the upper floors, and the tank size is 13.5 liter capacity

The flow rate of the sanitary appliance are:

WC cisterns flow rate is 0.11 liter/sec

Hand basin flow rate is 0.15 liter/sec

- The public water supply pipe is 8 inches radius (PPR).
- The entering pipe to the site property is (4-6) inches radius (PPR).

- The water pipe is connected to the underground water tank.

The public water supply pipe is 8 inches radius (PPR).

- The entering pipe to the site property is (4-6) inches radius (PPR).

- The water pipe is connected to the underground water tank.

Water Supply Pipe Diameter inch	Number of supply branched pipes diameter in inches								
	0.50	0.75	1.0	1.25	1.50	2.0	2.50	3.0	4.0
0.50	1								
0.75	3	1							
1.0	6	2	1						
1.25	10	4	2	1					
1.50	15	6	4	2	1				
2.0	32	12	6	3	2	1			
2.50	56	20	10	6	4	2	1		
3.0	88	32	15	9	6	3	2	1	
4.0	181	66	32	18	12	6	3	2	1

- The exiting pipe from the ground tank is 2'' Diameter and the main water supply vertical pipe for the toilets is 1.25'', and then into every sanitary appliance is 0.5''.

- The Green lawn is supplied with a 2 inches pipe from the main water pipe which branches to a  $\frac{3}{4}$  inch pipes and then to  $\frac{1}{2}$  inch which supply the sprinklers.

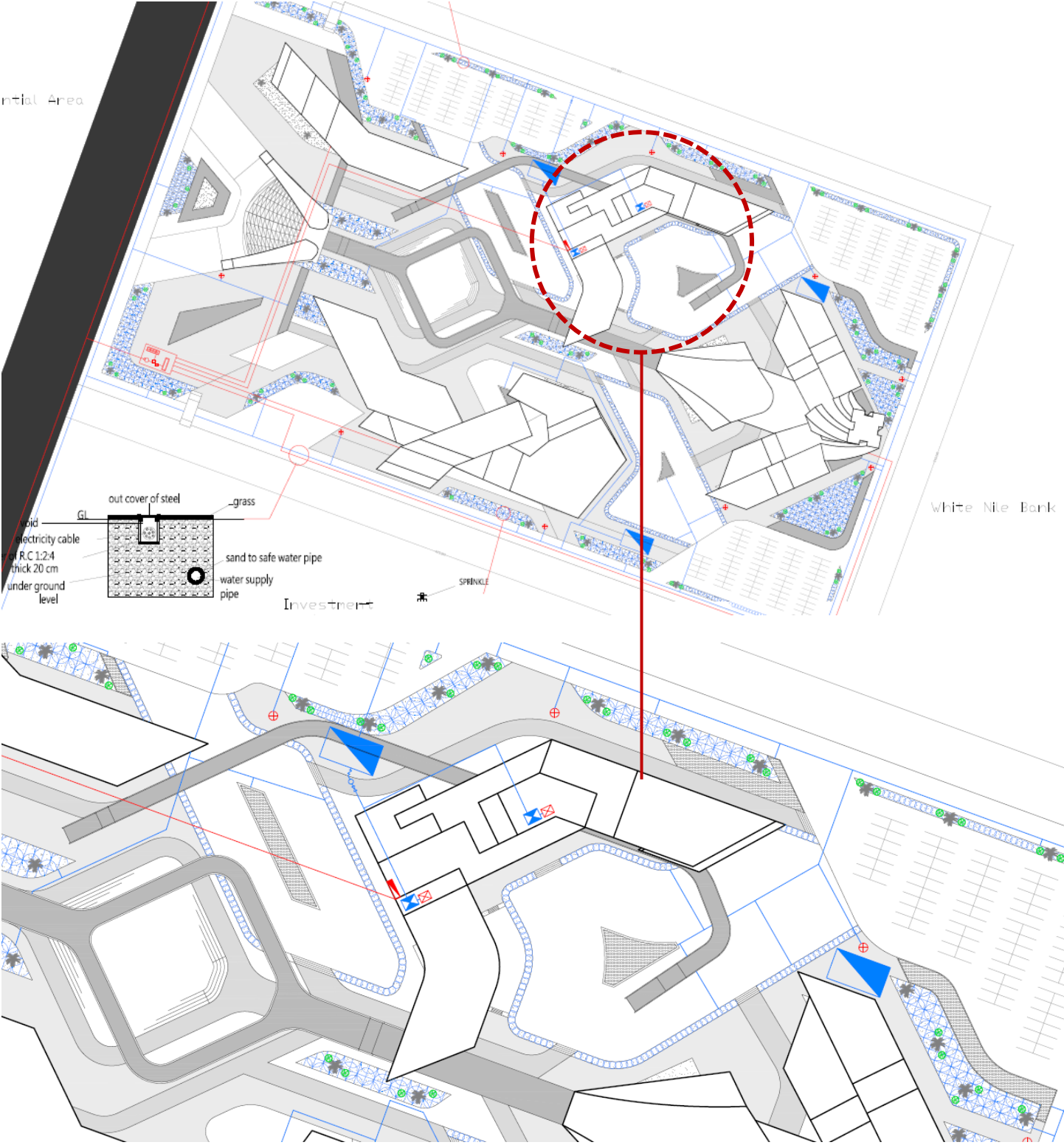

The figure above shows a part plan of the site where the library is located and shows the locations of the water tanks and the piping system, and the electrical conductors.

## 5-5 | Sewage and Drainage System

The used system is the Separate system; this has foul water from the sanitary appliances. Conveyed in a foul water drain to a foul water sewer. The rainwater from roofs and other surfaces is conveyed in a surface water drain into a surface water sewer or a soak away.

### Drainage Systems

#### A | Ground Surface Drainage

The site has different levels within the design of the outdoor and the landscape. Therefore, all the surfaces are drained through trenches and underground pipes, which eject the water to the White Nile River, considering it a clean natural water, which came from rains and any similar sources. The surfaces slope is 1:100.

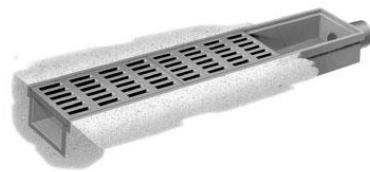

Illustrating Type M frame with grated cover. Standard with 4-inch outside caulk outlet. Can be equipped for inside caulk if specified.

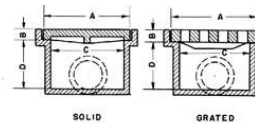

Trench covers are used over areas requiring long drainage assemblies. Can be supplied in a variety of sizes and lengths to meet special needs. For trenches of irregular pattern, arrangements can be made to furnish cover to fit.

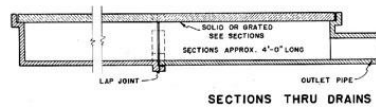

Standard 4-inch outlet at end of drain. Special size outlets are available on special order. Side and bottom outlets optional and furnished only when specified.

Sections: Thru Drains, Type M

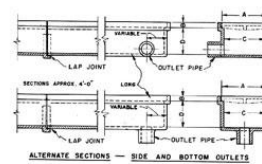

ALTERNATE SECTIONS — SIDE AND BOTTOM OUTLETS

As for the green landscape and lawns all the overflowed water are disposed through lawn drains.

#### B | Roofs Surfaces Drainage

All the flat roof surfaces of the buildings included in the project are drained through a slope, which is considered 2% of the length of the surface as minimum.

As for the pitched roofs they are drained through there slope.

All the water is gathered through concealed gutters, which lead to a concealed downpipe.





### Concealed Gutter & Downpipe

- The standard downpipe dimensions **10 x 10** cm

- The gutter dimension **15.24 x 11.43** cm

### Sewage System

The site property is located in a newly planned area, in south Omdurman in Salha region, at the direction of the new airport. The area does not have any kind of sewer system. Therefore, a water waste treatment plant is added to the site of the project.

The plant will be located at the east side of the property at non ventilated direction.

Norweco's Singular Aerobic Treatment System

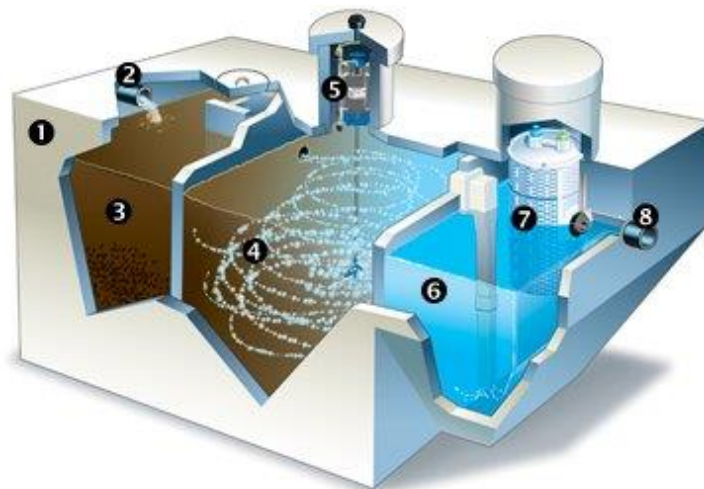

1. **Precast Concrete Tank:** The Singular tank, access risers and covers are reinforced precast concrete manufactured locally by your factory-trained, licensed Norweco distributor.
2. **Inlet:** Untreated wastewater enters the system here.

3. **Pretreatment Chamber:** Wastewater enters at the Singular inlet and is equalized here as anaerobic bacteria and gravity precondition it.
4. **Aeration Chamber:** Safe, living aerobic bacteria convert the wastewater into stable substances.
5. **Singular Aerator:** Our exclusive aerator infuses the fresh air that safe, living microorganisms require to fully digest and treat wastewater inside the aeration chamber.
6. **Clarification Chamber:** Flow equalization enhances the settling of biologically active substances inside the Clarification Chamber.
7. **Bio-Kinetic System:** Our Bio-Kinetic system combines filtration, settling, non-mechanical flow equalization, optional disinfection, adjustable outlet weir and optional DE chlorination features into a single package.
8. **Outlet:** Only a clear, safe and odorless liquid exits the system here for return to the environment.

Designed for domestic wastewater flows ranging from 500 to 1,500 gallons per day, performance of the Singular system is certified by NSF International and the Canadian Standards Association. Sold only through local, licensed, factory-trained distributors, the Singular system is backed by Norweco's fifty-year warranty and exchange program. The Singular system is a trouble-free answer to domestic wastewater disposal and insures a safe, sanitary home environment.

## Manholes

For the whole site property, the manholes are distributed at the main roads inside the project in shape of a public network, which they all lead to the treatment plant at the east side of the property.

The rodding point system is used for each of the building as an inexpensive access at the head of the drain or on shallow drain runs for rodding in the direction of flow.

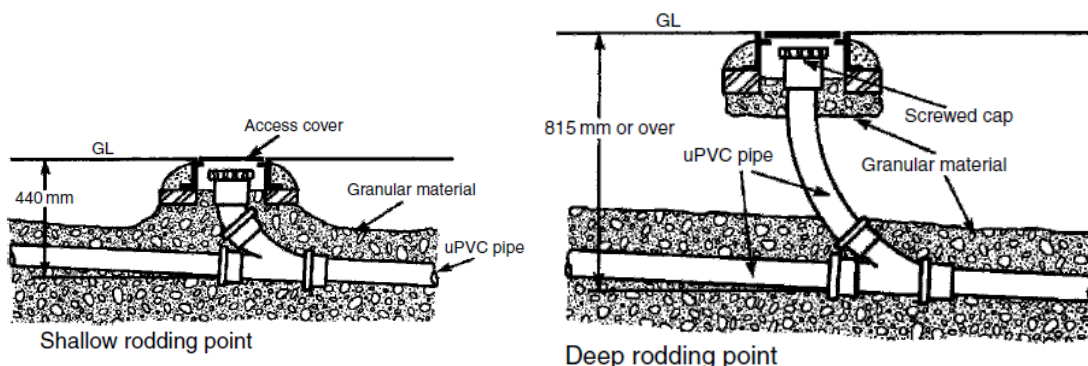

- The diameter of the foul drain is 12 inches

- The fall of the foul drain is 1:120, and the dimension of manholes are listed in this schedule

MANHOLE MARK	DEPTH IN CM	LENGTH IN CM	WIDTH IN CM	WALL THICKNESS IN CM
<b>MH<sub>1</sub></b>	45	45	45	12
<b>MH<sub>2</sub></b>	60	60	45	12
<b>MH<sub>3</sub></b>	70	75	57	24
<b>MH<sub>4</sub></b>	80	75	70	24
<b>MH<sub>5</sub></b>	87.5	75	70	24
<b>MH<sub>6</sub></b>	95	100	75	24
<b>MH<sub>7</sub></b>	105	100	75	24
<b>MH<sub>8</sub></b>	120	100	75	24
<b>MH<sub>9</sub></b>	135	100	75	24
<b>MH<sub>10</sub></b>	150	100	75	24
<b>MH<sub>11</sub></b>	161.25	100	75	24
<b>MH<sub>12</sub></b>	172.5	100	75	24

At the end of the network, there is a backdrop manhole, because of the difference in level between the site and the level where the treatment plant is located in the pavement at the border of the site

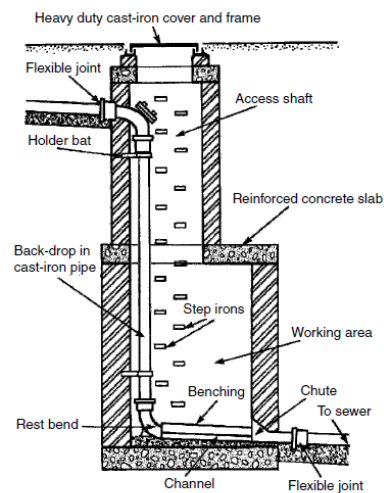

Detail of back-drop

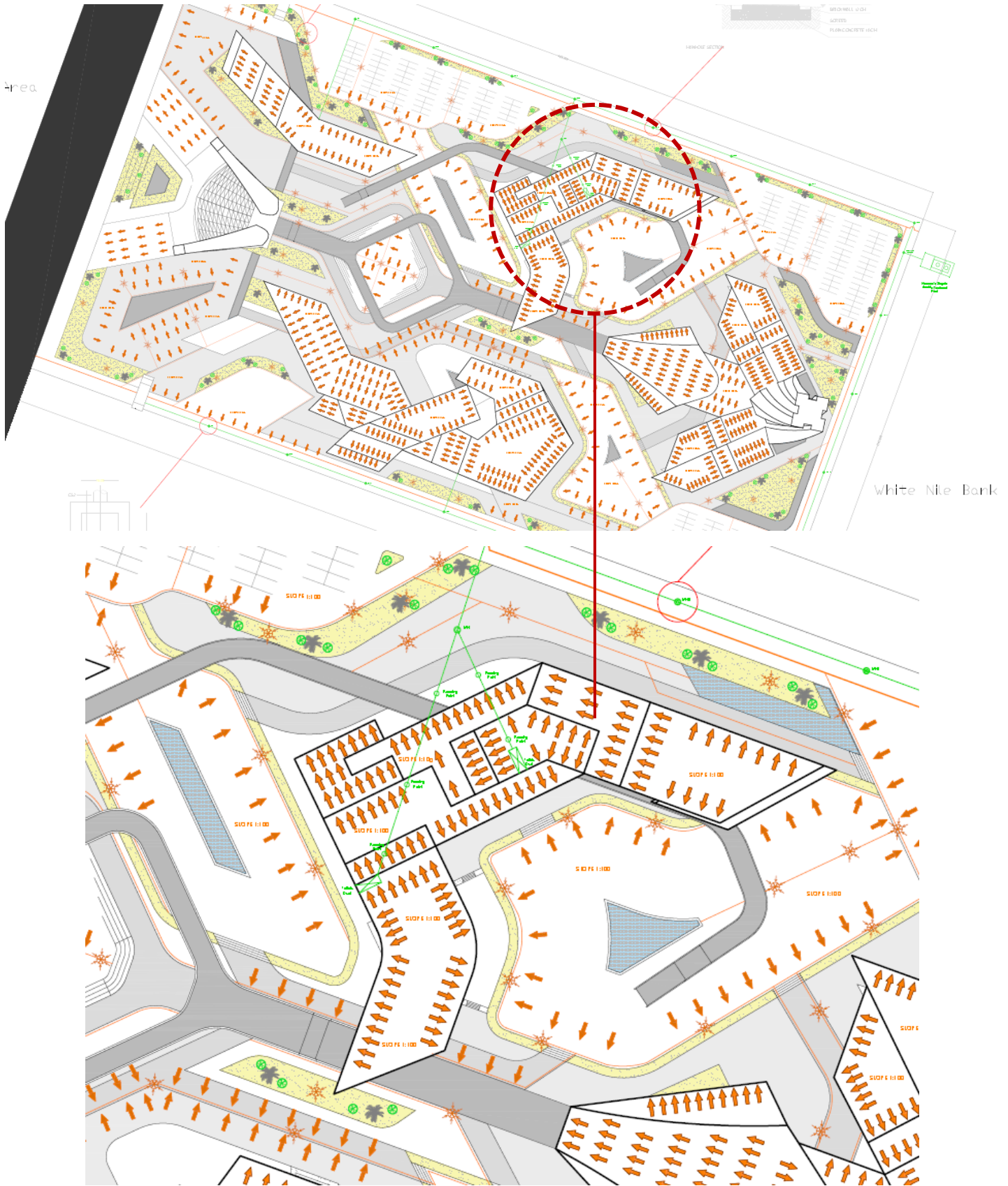

## 5-6 | Air Condition System

The determination of the HVAC system depends on specifying the buildings with its parts and sectors and this will be through the table below.

### Building Specifications & Air Condition System Selection

Space Function Type		Main Use of the AC System		Important Requirements		Less Important Requirements		AC Control System		Spaces Sizes	
*	Large main space	*	Cooling or heating	*	Temperature		Temperature	*	Central	*	Large
*	Multiple Spaces		Cooling or heating big quantities	*	Air recycling		Air recycling		Single space control		small
			Variable temperature	*	Quiet sounding		Quiet sounding				
				*	Humidity		Humidity				
				*	Sterilized Air		Sterilized Air				

(Table No 2)

For the air conditioning system, the all air system (AAS) has been chosen after completing the table No 1 and comparing it to table No 2.

### The Definition of the All Air System

This type of system only use the flow of air in the operation of cooling or heating, the air cycle goes with direction the exhausted air outside, and then supplying the building interior with fresh air that flows through ducts to all the sectors of the building.

### The Components of the (AAS)

1. An outdoor air handling unit (AHU) horizontal type.
2. An interior variable air volume unit (VAV) inlet.
3. Air ducts (squared, Round and flex).
4. Air terminal diffuser.



(2)



(1)

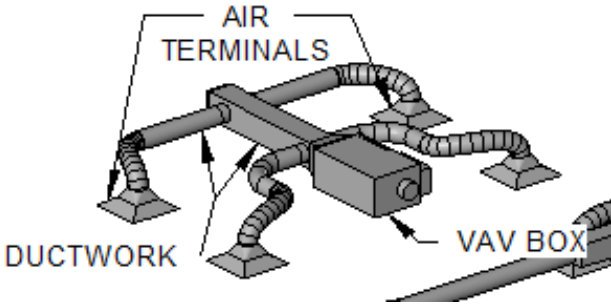

The figure below shows a 3D isometric view of the HVAC system and its assembly in the ground floor plan.

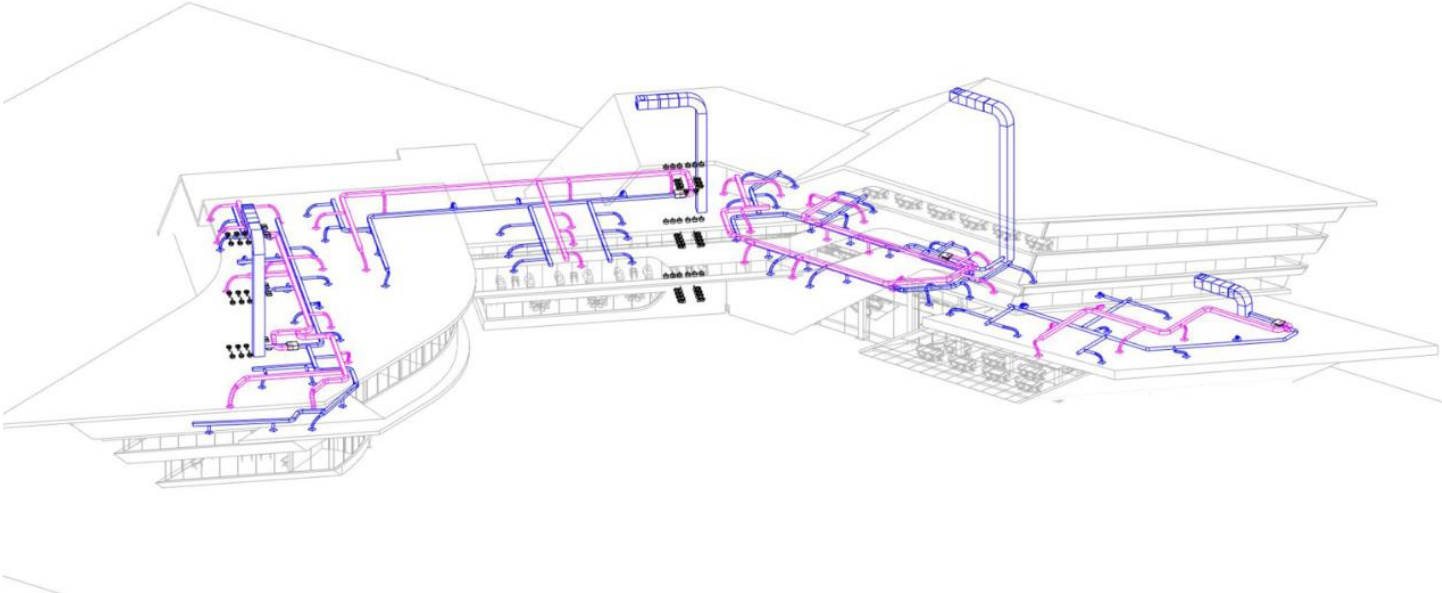

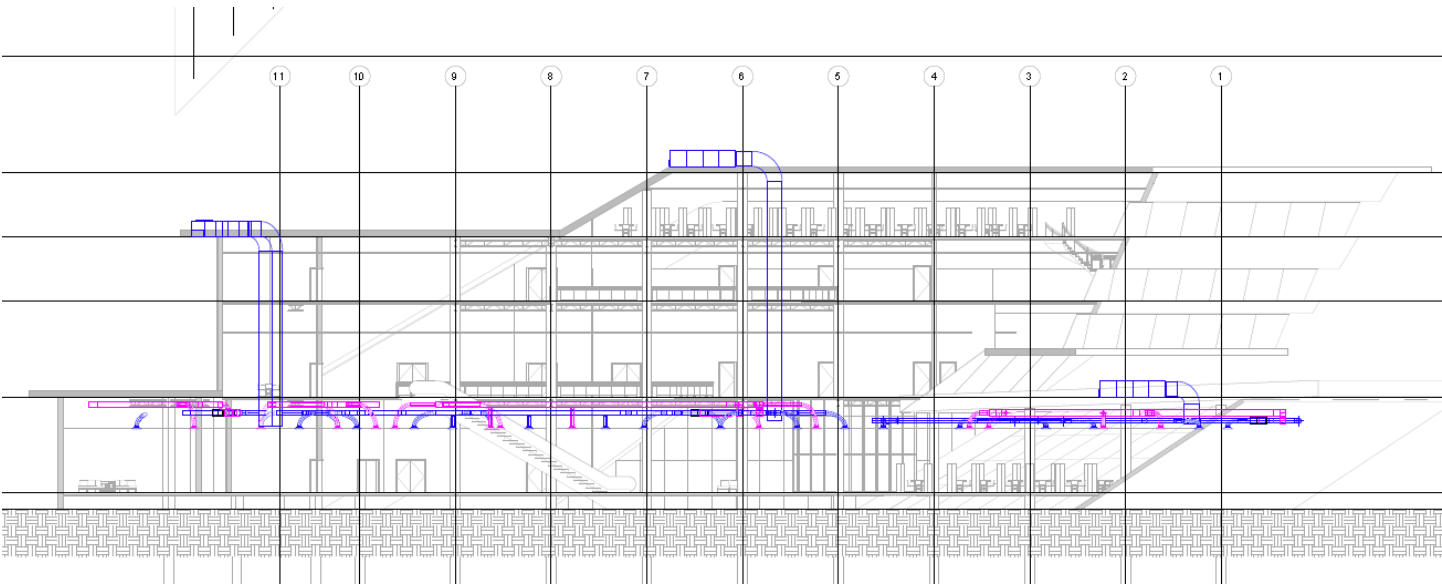
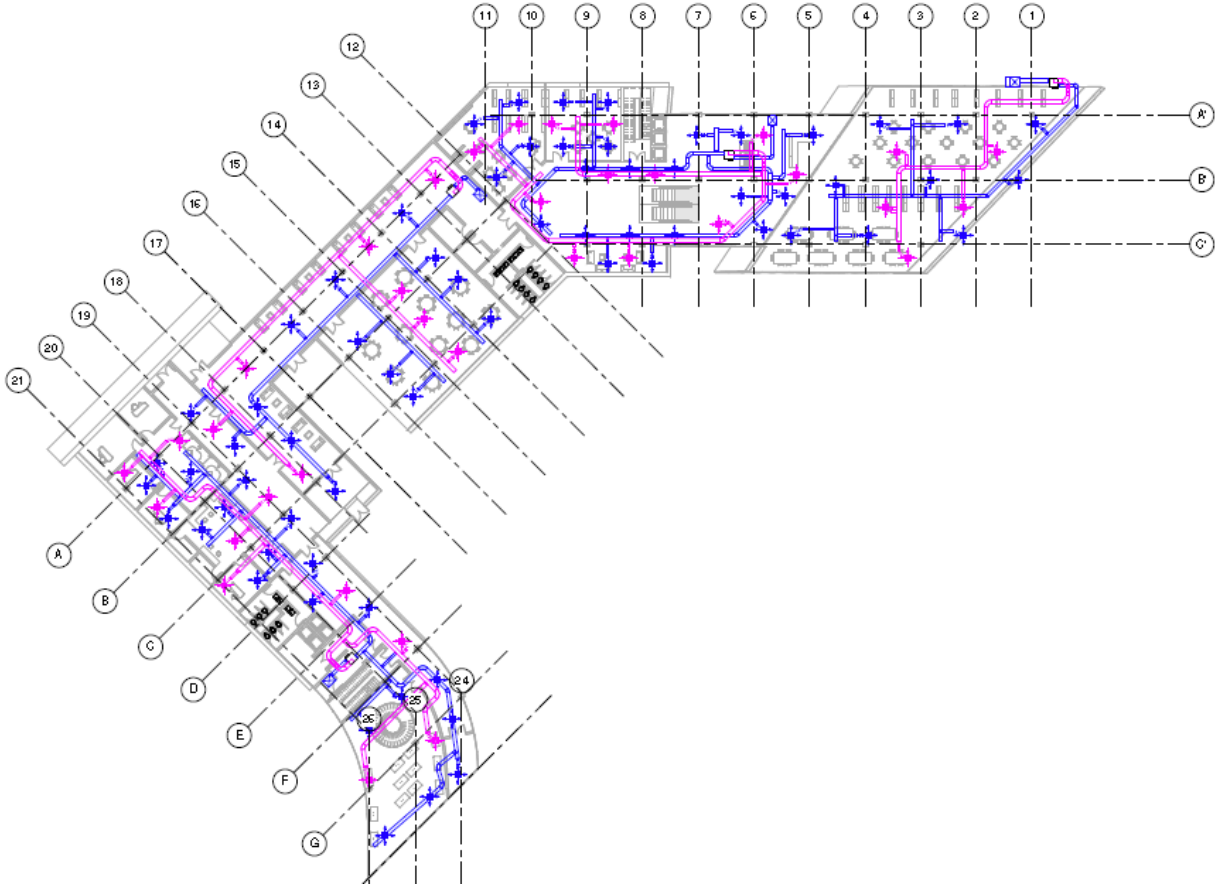

## 5-7 | Fire Fighting System

### Building Specifications

Building Masses		Building Risk Users Rating		Building Risk Components Rating		Space Function		Fire Rating Material Type		Building Dimensions	
*	Single Mass		Theater, Restaurants, Hospitals, Airports		High Hazard		Storing	*	A Hard carbon materials		2 floors with 1000 m <sup>2</sup> of area
	Single main mass + Scattered masses	*	Banks, Universities	*	Ordinary Hazard	*	Education Admin Housing and Hosting		B Flammable Liquids	*	5 Floors (Wet Pipes)
			Schools and Kindergartens		Light Hazard		Quiet sounding		C Electrical Equipments		Above 5 Floors (Dry Pipes)
			Factories				Industry		D Metallic and chemical Materials		
			Laboratories								
			Prisons								
			Commercial Buildings								
			Laboratories								
			Houses and Hotels								
			Warehouses								

After configuring the table above, the used fire protection for the building is the water and powder, looking at the class of the materials in the building and its fire rate.

- Moreover, for the detectors the selected system is the smoke detectors system.
- The fire extinguisher will be located at the entrance of the interior spaces.
- The fire hose reel will be located near the emergency stair.



### 5-7 | Fire Fighting System

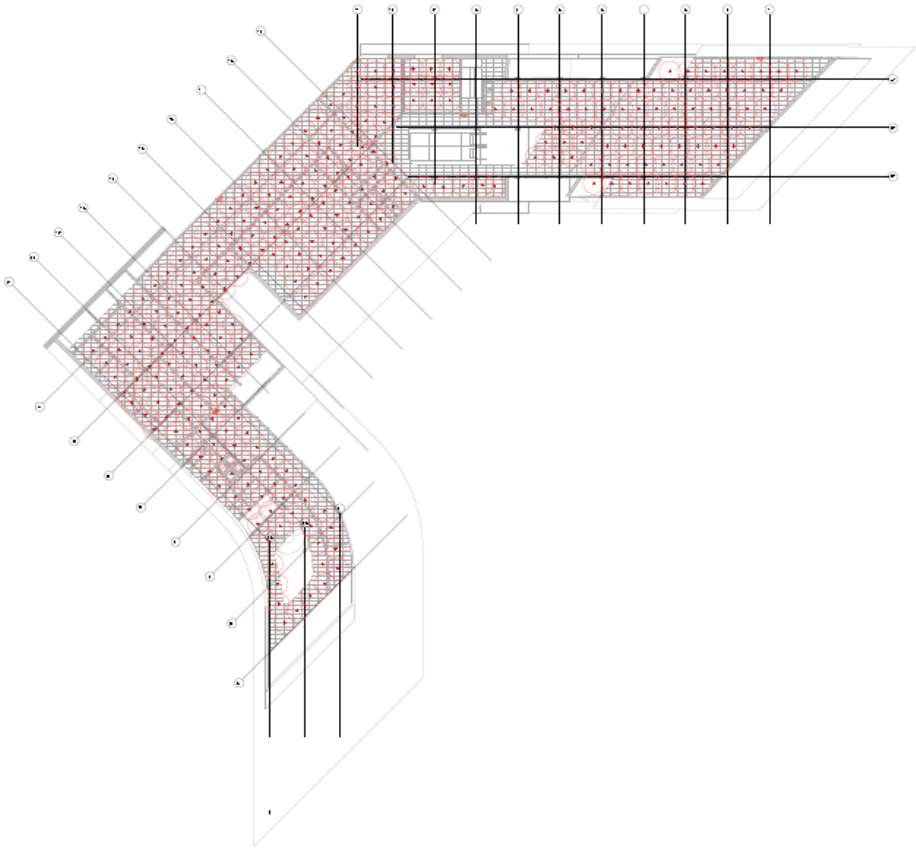

## 5-8 | Vertical Circulation System

### Vertical Circulation System Selection

<i>Small Homes &amp; Health Centers</i>	<i>Medium Size Apartment Building &amp; Small Hotels</i>	<i>High Rise Residential Building &amp; Office Buildings</i>	<i>Large Buildings with special Sectors</i>	<i>Crowded Buildings 6 floors maximum</i>
<i>Internal control system lifts</i>	<i>Down Aggregation Lifts</i>	<i>All Aggregation Lifts</i>	<i>Lifts allocation system</i>	<i>Escalator System</i>

### Initial Estimating of lifts Number

No of Lifts	Service Rate
1 every 3 stories	Good
1 every 4 stories	Acceptable
1 every 5 stories	Low

For the vertical circulation in the building looking at his specs both **Lift allocation system** and **Escalator system** had been chosen.

- The capacity of the lifts will be five persons per lift.
- The number of lifts is five lifts for the public and two for the services.

The figures below shows the part plans of the elevators and the stairs in the building from plans to section.

### Part Section of lifts and stairs

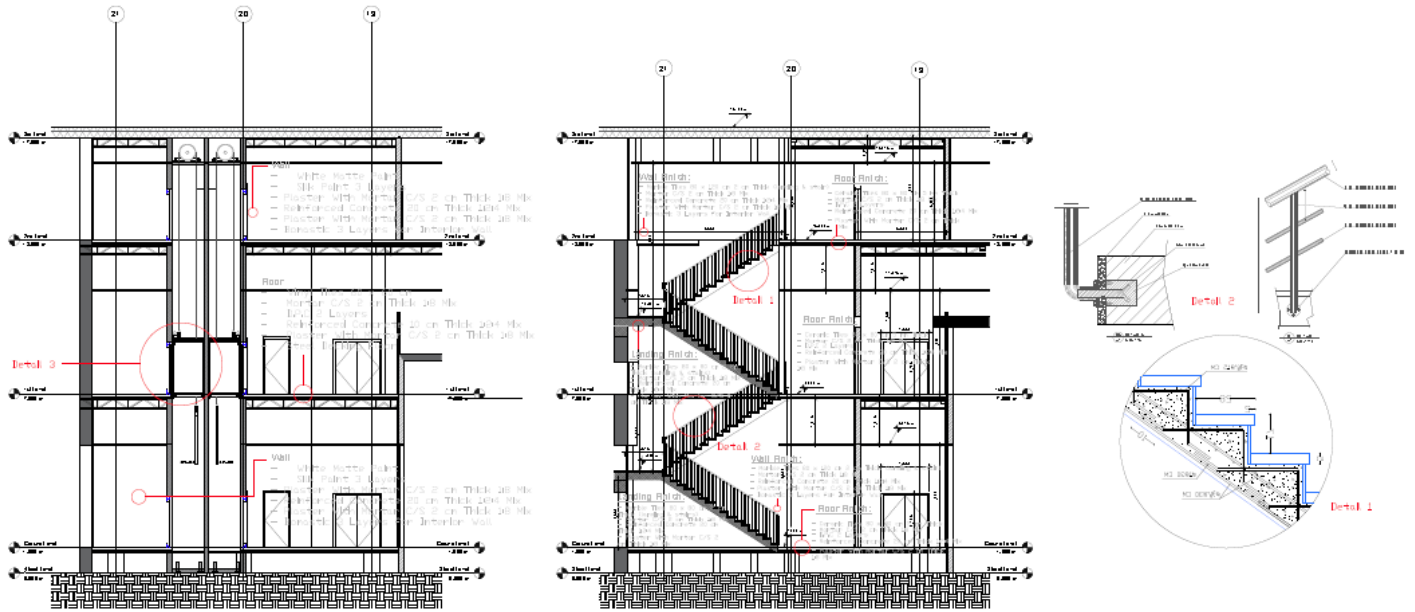

The figures below shows the circulation components both stairs and lifts, plan and section and some detail part of them.

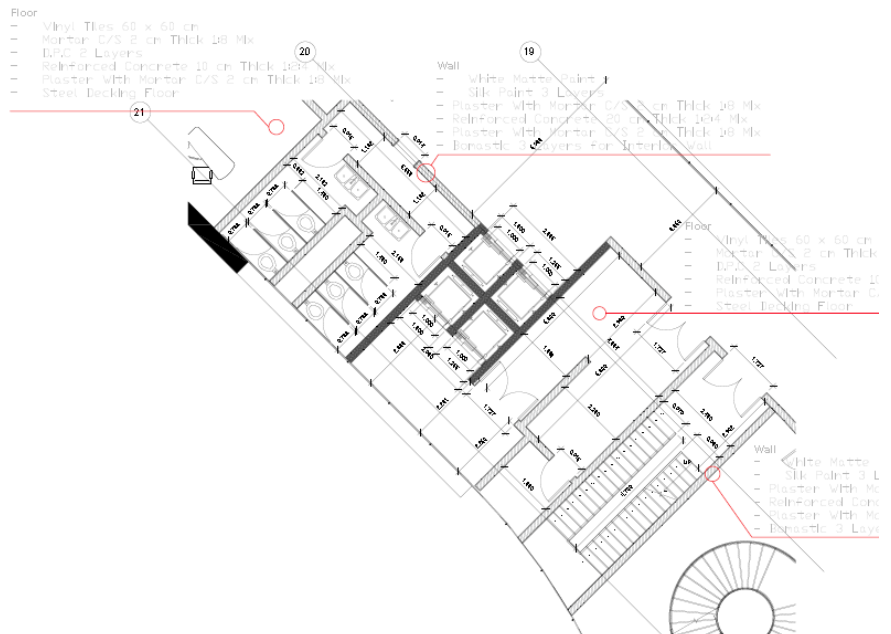
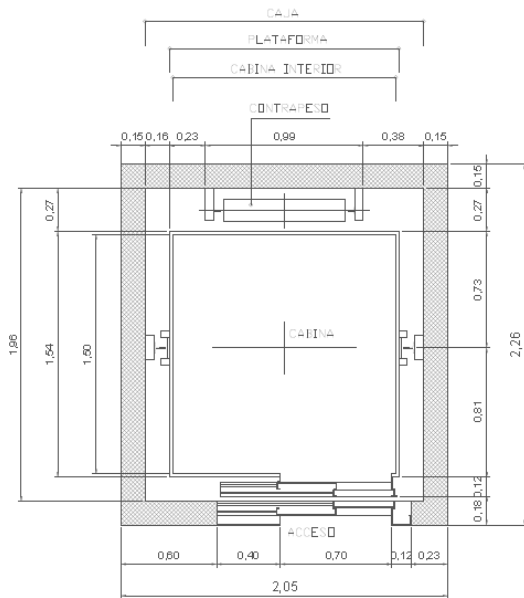

## References

### **Books**

Neufert Architecture 3<sup>rd</sup> Edition

Architectural Graphic Standards

Architecture Theory by Michel Heys 1968

Time Saver Building Types

Architect's guide to write for Design and Construction Professionals by Bill Schmal

Architectural metric handbook

Building construction handbook

Building Service handbook

### **Websites**

Google search engine

Wikipedia.com

Archdaily.com

meteoblue.com

Pinterest.com Search Engine

اللهم ربي لك الحمد بامالك نفسي  
تم بحمد الله...