



كلية الدراسات العليا

Sudan University of Science & Technology

College of Graduate Studies



Collage of Computer Science and Information Technology

Enhancing ATM Dispute Resolution Processing in Sudanese Banks

تحسين معالجة تسوية منازعات الصراف الآلي في البنوك السودانية

*A Thesis Submitted in Partial Fulfillment of the Requirements of
Master Degree in Information Technology*

By: Asmaa Ahmed Abd/Elrhman

Supervisor: Prof. Izzeldin Osman

2017



Approval Page

Name of Candidate: ..A.S.maa Ahmed AbdElrhman..

Thesis Title: ..Enhancing ATM Dispute Resolution
..Processing in Sudanese Banks..

Approved by:

1. External Examiner

Name ..Pr. Osama Ahmed Ibrahim..

Signature .... Date: ..9/3/2017..

2. Internal Examiner

Name ..Mohamed Elhatiz Mustafa Musa..

Signature .... Date: ..9/3/17..

3. Supervisor

Name ..Izzeldin Mohamed Osman..

Signature .... Date: ..9/3/2017..

Declaration

I, the undersigned, hereby declare that, unless otherwise referenced, the content of this thesis is the product of my own effort; and that this thesis as a whole, or any part thereof, has ever before been submitted for obtaining a degree or an academic or research title to any educational or research institution other than Sudan University of Science and Technology SUST (Sudan)

Dedication

To my beloved family

I love you the most

Acknowledgement

First of all, praise be to Allah (Subhanhu wa Tala'a) who granted me the strength and ability to peruse this study

My admiration and sincere appreciation to my thesis supervisor for his invaluable input, patient guidance and priceless support

My utmost gratitude and deepest thanks to my beloved family and sincere friends for their boundless love, support and tolerance

Abstract

The research introduces the process of ATM dispute resolution and highlights its effects on banks operational costs, customers trust to ATMs services as well as banks reputation. The research adopted a descriptive and comparative analysis of two Sudanese banks. Data was collected through conduction of in-depth interviews with dispute resolution personnel at the two banks. The data obtained from the banks employee answers the questions of research concerning steps and venues of filling an ATM dispute case, time and cost of ATM dispute resolution. Data was analyzed through data flow chart diagram to highlight the bottlenecks in dispute resolution process. The study offered a set of solutions to enhance technique of handling ATM dispute resolution in order to accelerate its end-to-end timeframe, decrease its operational costs and improve customer's satisfaction and loyalty.

ملخص

يقدم البحث معالجة تسوية منازعات بطاقات الصراف الآلي ويسلط الضوء على آثارها على البنوك من ناحية التكاليف التشغيلية، وثقة العملاء لخدمات أجهزة الصراف الآلي وكذلك سمعة البنوك . اعتمد البحث على تحليل وصفي ومقارن لاثنتين من البنوك السودانية . وقد تم جمع البيانات من خلال إجراء المقابلات المتعمقة مع أفراد تسوية المنازعات في البنكين . البيانات التي تم الحصول عليها من موظفي البنوك اجابت على اسئلة البحث المتعلقة بخطوات وطرق تقديم طلب المنازعة والوقت والتكلفة المطلوبين لحل منازعات بطاقات الصراف الآلي . تم تحليل البيانات من خلال مخطط تدفق البيانات لتسليط الضوء على الاختناقات في عملية تسوية المنازعات . ولقد قدمت الدراسة مجموعة من الحلول لتحسين آليات معالجات تسوية منازعات بطاقات الصراف الآلي من أجل تقليل الإطار الزمني للمعالجة، وخفض التكاليف التشغيلية من اجل تحسين رضا العملاء وزيادة ولاء العميل .

List of Figures

Figure No.	Page No
Figure 2-1	5
Figure 3-2	13
Figure 4-3.....	21
Figure 4-4.....	22
Figure 4-5.....	22
Figure 4-6.....	23
Figure 4-7.....	23
Figure 4-8.....	24
Figure 4-9.....	24
Figure 4-10.....	25
Figure 4-11.....	26
Figure 4-12.....	26
Figure 4-13.....	27
Figure 4-14:	27
Figure 4-15:	28
Figure 4-16:	28
Figure 4-17:	29
Figure 4-18:	29

LIST OF ABBREVIATIONS

Abbreviation	Full Name
ATM	Automated Teller Machine
RDP	Resolution Dispute Personnel
IDIs	In-Depth Interviews

List of content

Declaration.....	I
Dedication.....	II
Acknowledgment.....	III
Abstract(English).....	IV
Abstract (Arabic)	V
List of Figure	1
List of Abbreviation	1
1. Introduction	
1.1 Background	1
1.2 Statement of the problem	2
1.3 Purpose of the study	2
1.4 Significance of the study	2
1.5 Research questions	2
1.6 Limitation of the study	2
1.7 Organization	2
2. Literature Review	
2.1 Automated Teller Machine(ATM)	3
2.1.1 Advantages of ATMs	3
2.1.2 Disadvantages of ATMs	3
2.2 Regulator bodies of ATM	4
2.2.1 Central Bank of Sudan	4

2.2.2 EBS	5
2.2.2.1 EBS Objectives	5
2.2.2.2 EBS Services	6
2.2.2.2.1 National Switch Center.....	6
2.2.2.2.1.1 Services provided to banks	6
2.2.2.2.1.2 Services provided to cardholders	7
2.3 Disputed Transaction.....	7
2.3.1 ATM dispute.....	8
2.4 Previous studies	8
3. Methodology	
3.1 The Methodology	11
3.2 Population and sampling	11
3.3 The instrument	11
3.4 Topic guide of IDIS	12
3.5 Procedures for the data analysis	12
4. Analysis and discussion of the data	
4.1 Research Findings	14
4.1.1 Filling an ATM dispute case	14
4.1.2 Determine ATM dispute category	14
4.1.3 Verification of disputed ATM transaction	15
4.1.4 Time frame of ATM dispute resolution	15
4.1.5 Steps of internal dispute resolution	15
4.1.6 Steps of external dispute resolution	15
4.1.7 Communication of the dispute result to bank customer	16

4.1.8 Cost of ATM dispute resolution	16
4.1.9 Staff's proposed interventions for optimization of ATM resolution process	17
4.2 Analysis and discussion of the data	17
4.2.1 Filling an ATM dispute case	17
4.2.2 Determine ATM dispute category	18
4.2.3 Time frame of ATM dispute resolution	18
4.2.3.1 Time frame of internal dispute resolution	18
4.2.3.2 Time frame of external dispute resolution	19
4.2.4 Communication of the dispute result to bank customer	19
4.2.5 Cost of ATM dispute resolution	19
4.3 Proper Venue	20
4.3.1 Analysis for Proper Venue	20
4.3.2 Screen for Proper Venue	26
4.3.2.1 Screen for filing and query dispute ATM through ATM	26
4.3.2.2 Screen for web site venue	28
5. Conclusion, Recommendations and Future research	
5.1 Conclusion	30
5.1.1 Bottlenecks in ATM dispute resolutions	30
5.1.2 Strategic levers	30
5.2 Recommendations	31
5.3 Future research	31
References	32
Appendices	

Chapter One

Introduction

1.1 Background

The growing demand to banking services prompts banks to relieve labor pressure, facilitates banking services delivery and keeps up with development in banking sector through E-banking. Daniel, E. Sathye defined E-banking concept as “The automated delivery of new and traditional banking products and services directly to customers through electronic, interactive communication channels”. [1] Adoption of E-banking lead to improve its business environment, enhance relationship with customers, improves the efficiency and effectiveness of banks transaction, facilitate lunningg to new markets, gain competitive advantages, raise the national economic level, reduces the operational costs and increase profits.

Automated Teller Machine (ATM) is a form of E-banking. “It’s an electronic telecommunications device that enables the customers of a financial institution to perform financial transactions, particularly cash withdrawal, without the need for a human cashier, clerk or bank teller. [2] ATM is the central instrument in retail E- banking. To gain competitive advantages, reduce costs and increase profits, banks trend to invest on ATMs.

1.2 Statement of the problem

ATM Dispute occurs when a cardholder fails to dispense part or all of money requested from ATM machine although the amount was debited from his account. [3] Fails in dispensing money occur due to the following reasons: Connectivity problems, ATM problems and cardholder error. [4] Failures in dispensing money influences quality, convenient of ATM services, trust of customers and waste their time in procedures of retrieving their money back.

The increase use of debit cards raises rate of disputed transactions and charge backs that consequently influence customer’s satisfaction to ATM banking services. The annual growth of disputed volume is 19% over year and it imposes additional burden to banks as it requires several stakeholders, physical and effort rigorous and supplementary operating cost. [5,6]

Dispute ATM negatively affects reputation of banks; quality and convenience of banking services and decreases customer’s loyalty. Banks make efforts to solidify customer relationships and improve the effectiveness and efficiency of banking services. In order to manage dispute ATM successfully, highly qualified well-experienced full-time employees are pre-requisite.

Dispute resolution process is time and cost intensive as it requires ongoing investment to sustain technology and involves multiple stakeholders to handle the process. [5,6]

1.3 Purpose of the study

This study aims to identify factors that could potentially enhance efficiency and effectiveness of ATM dispute resolution process in order to decrease its operational costs and improve customer's satisfaction.

1.4 Significance of the study

Improving the efficiency and effectiveness of ATM dispute resolution process will increase bank profits and increase customer's trust and loyalty.

1.5 Research questions

1. How does a customer (cardholder) file an ATM dispute case?
2. How customer could follow-up his ATM dispute case?
3. What are the steps of ATM dispute process?
4. How long does the resolution process usually take?
5. What are the costs of ATM dispute process?
6. What are the recommendations for optimizing the resolution process?

1.6 Limitations of the study

This study could not assess customer's (cardholder's) experience and satisfaction in relation to mechanism of ATM dispute resolution.

1.7 Organization

This thesis contains five chapters; chapter one is the introduction, Chapter two is the literature review while chapter three describes the methodology adopted for data collection and analysis. Chapter four comprises analysis and discussions. Chapter five consists of conclusions, recommendations, and suggestions for future research.

Chapter Two

Literature Review

2.1 Automated Teller Machine (ATM)

ATM is a form of E- banking. “On most modern ATMs, the customer is identified by inserting a plastic ATM card with a magnetic stripe or a plastic smart card with a chip that contains a unique card number and some security information such as an expiration date. Authentication is provided by the customer entering a personal identification number (PIN). Moreover, if the currency being withdrawn from the ATM is different from that in which the bank account is denominated the money will be converted at an official exchange rate. Thus, ATMs often provide the best possible exchange rates for foreign travelers, and are widely used for this purpose”. [2] ATM enables customers to perform the following transaction [7]

- Check account balance
- Cash withdraws
- Cash deposit
- Cash transfer
- Pay bills
- Get bank statement

2.1.1 Advantages of ATMs: Are listed below [7]

- ATMs make banking services accessible 24hrs a day and customers do not have to wait bank opening time.
- ATMs decrease customers load on banking services inside banks branches thus they decrease the cost of banking services.
- ATMs provide customers with privacy in accessing banking services
- The widespread of ATMs facilitates getting of banking services and customers don't have to carry money in their pockets

2.1.2 Disadvantages of ATMs: [7]

- The bank has to monitor ATMs, fills it continuously with money and guard ATMs against theft.

- Loss or theft of ATMS card allows unauthorized access to bank accounts and dispensing customer's money from an ATMS.
- There is an upper limit to the amount of money a customer could dispense from an ATM per day.
- Break down of ATMs affects customer's ability to access services and requires continuous requirement maintenance.

2.2 Regulator Bodies of ATM

ATM in Sudan is regulated by central bank of Sudan through EBS

2.2.1 Central bank of Sudan

Central bank of Sudan was established in 1959 to undertake the functions of the Central Bank stipulated in the Bank of Sudan Act. [8] These functions included [9]:

- Issue the national currency.
- Issue monetary and financing policies, and manage the same, in consultation with the Minister (Minister of Finance and National Economy) in such way, as may achieve the national objectives of the national economy.
- Organize banking business, monitor and supervise, strive to promote and develop and raise the efficiency thereof, in such way, as may achieve the balanced economic and social development.
- Strive to achieve economic stability and the stability of the par value of the Sudanese Dinar.
- Act, in its capacity as the bank of the Government, as an advisor and agent thereof, in the monetary and financial affairs.
- Abide, in the discharge of the duties, achievement of the objects, exercise of the powers and supervision thereby, of the banking system.

2.2.2 EBS [10]

EBS is the technical arm of Central bank of Sudan (CBOS) in the implementation and operation of the banking technology projects, EBS was established at the initiative of the Union of Sudanese Banks and was fully supported by Central Bank of Sudan at the end of 90's, and started its activity in mid-2000 and began in implementation of projects in early 2001. The shareholders of EBS are central Bank of Sudan, Sudatel and banks. Please see figure (1).

EBS after its establishment played a positive role in the economic sector through its concern in the technical banking hence the Sudan technical banking scheme became a national scheme officially supported from the government.

EBS provides the modern electronic payment methods for advanced banks, to facilitate the needs of customers and cardholders and achieve the abundances funding for economic revival. EBS aims to develop an electronic payment system in Sudan, which are reflected in development and growth on the economical side in the Republic of Sudan.

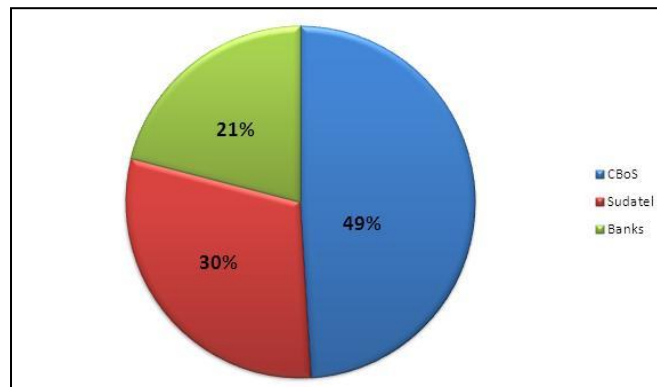

Figure 1: Shareholders of EBS

2.2.2.1 EBS Objectives [11]

- Created infrastructure for electronic payment systems.
- Connect banks to a unified banking network.
- Offer electronic payment services in Sudan.
- Bring banking technologies from abroad and indigenization in proportion to the local environment.

- Contribute to publishing a culture of banking technology in Sudanese society.
- Offering technical consultancy in the field of technology for banks and financial institutions.

2.2.2.2 EBS Services [11]

- SWIFT Networks Services .
- National Switch Center .
- National Electronic Cheque.
- Card personalization services.
- Banking info network services .
- Value Added Services .
- SMS Services .
- POS Services.
- ATM Services.
- Internet Services (E Commerce).

2.2.2.2.1 National Switch Center [12]

The center aims to enter plastic money extensively in the economy, as a means of innovative for electronic payments that facilitate the lives of cardholders. Also it enables banks to provide electronic banking services without limits of temporal or spatial. Services provided by National Switch Center listed as below:

2.2.2.2.1.1 Services provided to Banks:

Manage and operating the main servers of the national switch for Automated Teller Machine (ATM), Point Of Sale (POS), and Short Message Service (SMS).

- Offering the technical support for the banks to enable them to manage their own ATM.
- Linking and testing the interface for banks / and switches.
- Serve of management for ATM and Card management System (CMS).

- Offering the necessary reports to Central Bank of Sudan (CBOS) for conduct clearance between banks, and offering reporting for banks to meet their needs.
- Customer Services for banks and cardholders.
- Offering a service for the resolution of disputes between banks.

2.2.2.2.1.2 Services provided to Cardholders

- Cash withdrawals.
- Balance Inquiry.
- Mini statement
- Change Personal Identification Number (PIN).
- Account transfer.
- Card-less transfer.
- Value Added Services (VAS) (top-up, bill payment, and purchase electricity).

2.3 Dispute Transaction

Most bank transactions are properly carried out following the instructions of the account owner and are done effectively without any troubles. However, sometimes errors appeared. Therefore, account owner raises a claim or dispute the transaction as she/he didn't authorize the transaction or authorized it but it was not finalized correctly. Disputed transactions involve plastic cards, cheques, internet banking, paying-in machines and transactions made over the counter. [13] An unauthorized transaction takes place when someone managed to steal ATM card and PIN or fraud of ATM card which means that an unauthorized person had gain ATM card and PIN information. [14]

Huge efforts are undertaken by banks in investigating and interpreting the evidences of disputed transaction so as to properly identify who is liable for dispute, prove whether it happened due to a customer fraud, a third party criminal attack, a customer negligence in protecting their ATM card or technical problems. [14] Legitimacy of customer's disputed transaction is verified by checking the e-journal file which contains all ATM transactions log files. [15]

Dispute resolution process is time and cost intensive to all stakeholders especially card issuing bank and could reduce the profits if the transactions are credited back to the card holder. When a transaction is disputed by the cardholder, it sets into motion a complex, time consuming, expensive and resource-intensive sequence of events to identify the exact reason – called the “Reason Code” - for a chargeback. [5, 16]

Identification of dispute reason codes could either be processed manually or automatically. Manual reason code identification increases turnaround time for settlement of a dispute. Moreover, manual identification requires extensive training (and refreshment training) which adds to operational costs. Furthermore, it is prone to subjective interpretation of a dispute which may lead to human error in the identification of the right reason code. On the other hand, automatic identification of dispute reason codes eliminates subjectivity and hence produces positive impact on dispute resolution process and business operations. Investment in automation has been proven to lower the end-to-end dispute resolution process cost by up to 50 percent. Furthermore, automation solidifies customer relationships especially when coupled with a well-structured dispute department. [6]

2.3.1 ATM dispute

ATM Dispute transactions are divided into two categories; internal dispute and external dispute. Internal dispute occurs at an ATM owned by the bank which issued the ATM card. On the other hand, external dispute occurs at an ATM that is not owned by the bank which issued the ATM card. Internal dispute shall not take more than 24 hrs to be resolved where external dispute could take up to 72 hrs to be resolved.

2.4 Previous studies

Best Practices for Managing Cardholder Dispute and Chargeback Processes in Challenging Times by Robert Hadden [5]

This paper highlighted that managing cardholder disputes is an essential element in providing excellent customer service and if handled properly, it could have a significant positive impact on customer relations. Dispute and chargeback processes involve multiple stakeholders and required expert resources and a keen understanding of how to interpret Payment Networks

Rules and Federal Legislation affecting response time. Chargeback and dispute processing can be an expensive proposition that requires ongoing investment to sustain technology, manage employee training and turnover, and ensure compliance to Payment Networks Rules and Federal Legislation. Finally, the paper outlined the need to alternative model; whether managed in-house or outsourced, that will enhance the efficiency and effectiveness of dispute resolution departments by:

- Utilize deep industry knowledge.
- Shift to an experienced, front-end chargeback representative model to enhance the customer experience.
- Develop a highly-qualified central support team.

Card disputes and charge backs improving customer experience while reducing costs Sumit Sood, Joseph Pinipe [6]

The author mentioned credit and debit card users are showing declining levels of satisfaction because of the manner in which disputes are handled as result to time frames to resolve card disputes are growing longer, there is a lack of engagement with the card user during the process and chargeback teams have to cope with frequent changes in Payment Network Association (PNA) rules for disputes settlement. Charge backs add operating costs of issuing banks. The author summarize, the manual process to manage charge backs is prone to errors and can take between 45 - 120 days to resolve. In conclusion he derived for a disputes and chargeback leader, the key to success is to ensure that disputes are closed quickly and accurately. This implies automating the process, using guided documentation processes and workflows, eliminating agent errors, introducing a high degree of intelligence and analytics into the chargeback management framework.

Four Effective Ways to Optimize the Credit Card Dispute Resolution Process by Balamurugan Soundararajan:[17]

The paper outlines four measures for optimizing dispute resolution. Firstly breaking down the Process into Smaller Steps through batch processing advantages will be offered like greater specialization as employees gain expertise in a limited set of tasks; faster on-boarding of agents because they required to learn only limited portions of the entire process ; greater

accuracy as simpler process steps lead to improved first pass yield; efficient skill-based work allocation as batch processing facilitates efficient skill-based allocation which led to higher productivity and increased accuracy. Secondly improving process efficiency with Standalone Tools such as Merchant Portals as traditional dispute resolution processes are error-prone, led to low fraud recovery rates, high operational write-offs, and increased cost of operations. By adopting it benefits will be obtained as improved productivity through process automation and focusing on core activities instead of performing ad hoc tasks; seamless processing through a workflow engine will eliminates manual work and assists in seamless queue based processing, also it supports efficient allocation of cases and processing of priority instructions, and generates automated real-time reports; effective digital servicing channel since it provides the required audit trail. Thirdly creating an Expert Support Team so banks can ensure business process continuity, enable knowledge and resource management, enhance the success rate. Finally Ensuring Effective Customer Contact Management to enhance quality of dispute resolution, ensures customer satisfaction, gain understanding of customer challenges and reduce dispute volumes

Chapter Three

Methodology

3.1 The methodology

The study adopted a descriptive and comparative analysis of two Sudanese banks; Faisal Islamic Bank and Export Development Bank as well as literature of review to answer the study objectives. Data Collection was conducted through in-depth interview utilizing a topic guide to evaluate ATM dispute resolution process at the two banks.

3.2 Population and sampling

Two banks have been selected; Faisal Islamic Bank and Export Development Bank.

Faisal Islamic Bank (SUDAN) was established in accordance with Temporary Order No (9) (1977) dated 04/4/1977. The Bank commenced operations in May 1978. The main activity of bank is to conduct all forms of banking activities, financial, commercial, investment as well as participation in economic development and social projects. To promote transactions and cooperation in the field of foreign trade, in conformity with Islamic Sharia law, and advanced modern developed banking techniques. Faisal Islamic Bank has 136 ATM, 34 branches, 1238 employees and a private switch. [18]

Export Development Bank is a limited liability public company established under the name (The Islamic Bank of Western Sudan), which was changed to (Alghareb Islamic Bank) and later changed to (Export Development Bank) in January 15, 2003. The national private sector holds about 83.14 % of the capital of the bank whilst the shares of the Central Bank, government entities and other semi-government Export development bank has 22 branches and 36 ATMs. Export development bank does not have a private switch and provides its E-banking services through national switch centre. [19]

3.3 The instrument

In-depth interviews (IDIs) were conducted with DRP at headquarter and a branch of each selected study site so as to have a deep understanding of ATM dispute resolution process at each bank, answer the research questions, identify bottlenecks in the process and formulate recommendations for optimizing resolution process. Total number of employees was six; IDIs were conducted to three employees for each bank.

3.4 Topic guide of IDIs:

1. How long have you been working at Customer Service/ Dispute Resolution?
2. How could a cardholder file a dispute case?
3. What are the venues through disputed transactions could be filed?
4. How do DRP identify the dispute reason code?
5. How long does an internal dispute case take to be resolved (end-to-end internal timeframe)?
6. How long does external dispute case take to be resolved (end-to-end external timeframe)?
 - Card issuing bank approves EBS's feedback.
 - Card issuing bank disapproves EBS's feedback and requests re-checking the E-journal of acquirer bank)
7. How does a cardholder receive information resolving disputed transaction?
8. What are the costs of ATM dispute resolution?
 - In terms of time, labor, training of staff and infrastructure.
9. What are your suggestions for quality improvement of ATM resolution process at your bank?

3.5 Procedures for data analysis

Data was analyzed through work flow diagram to identify the steps and bottlenecks in ATM dispute resolution process. Flow chart is used to represent the data.

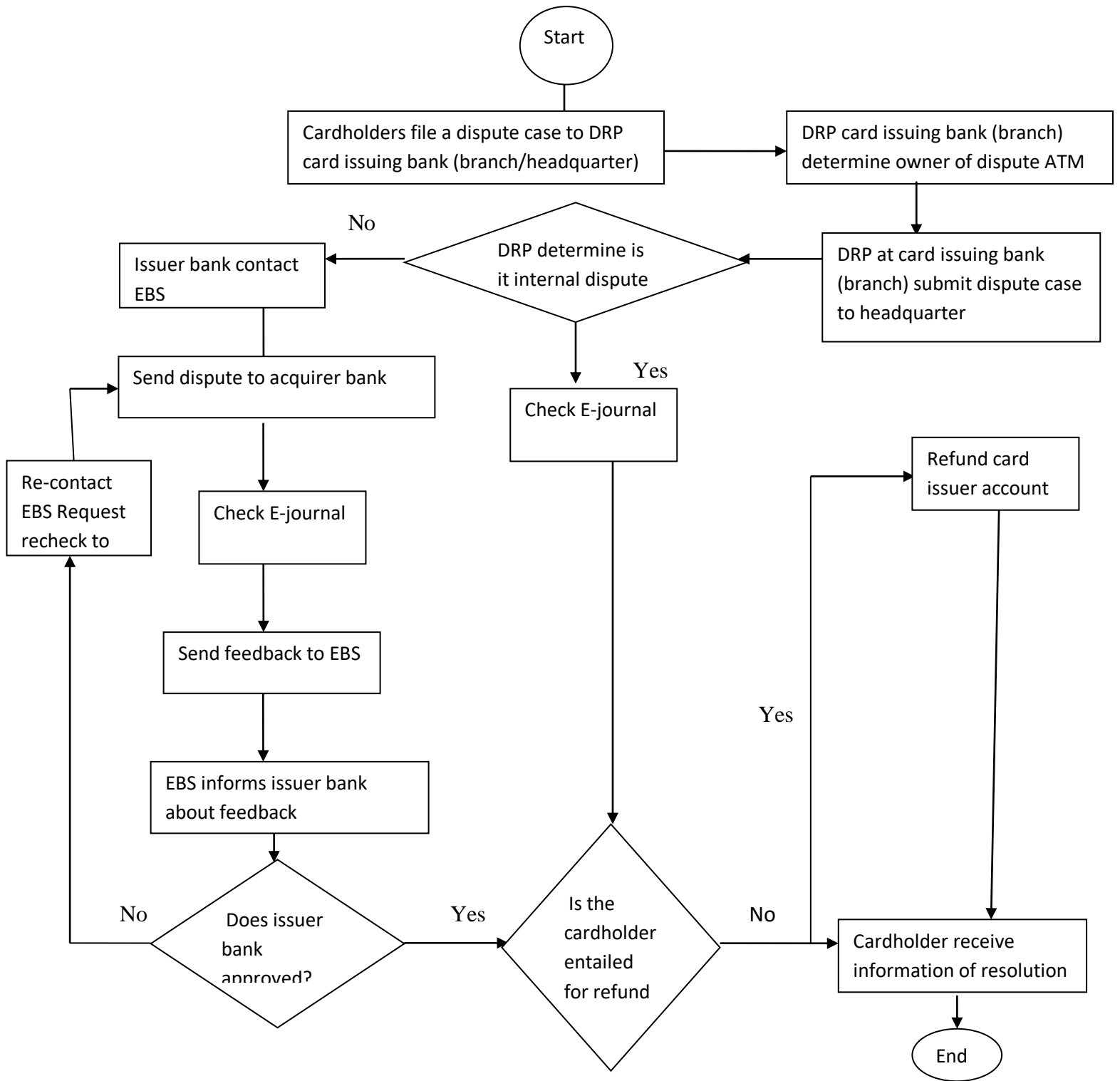

Figure 2: Data flow diagram for dispute resolution

Chapter Four

Analysis and discussion of the data

4.1 Research Findings:

Findings of In-depth interviews (IDIs) are presented as below:

4.1.1 Filing an ATM dispute case

At Faisal Islamic Bank:

- Cardholder files a dispute case by filling a dispute form detailing the name of the cardholder, type of bank account, number of cardholder's bank account, time, site and circumstances of the disputed ATM transaction at headquarter or any bank branch.
- Filing ATM dispute case could be through the following venues; customer service, SMS, and in person. However, if cardholder does not file the dispute case in person, customer service representatives fill the dispute form and await Dispute resolution personnel (DRP) to handle the issue.
- DRP at card issuing bank branch submit the dispute form along with bank statement to DRP at headquarter bank through internal program if the disputed ATM transaction takes place at an ATM belonging to the bank (internal dispute) or E-solution program if the disputed transaction takes place at an ATM belonging to another bank; acquirer bank (external dispute).

At Export Development Bank:

- Cardholder files a dispute case by presenting himself at headquarter or any bank branch. Filing dispute case could only take place at bank opening hours.
- DRP at card issuing bank branch submit the dispute forms with bank statements annexed to headquarter through internal circuit. Internal circuit operates twice per day.

At both banks, submission of a dispute case to headquarter bank takes no longer than 24hrs.

4.1.2 Determine ATM dispute category

At Faisal Islamic Bank, although DRP at the bank branch could determine whether the dispute case is an internal or external issue, headquarter of Faisal Islamic Bank will still verify whether the dispute case is an internal or external issue (DRP at headquarter will review the bank ATM code at which the disputed transaction takes place).

Regarding Export Development Bank, DRP at headquarter bank are the only ones who could determine whether the dispute case is an internal or external issue.

4.1.3 Verification of disputed ATM transaction

DRP verify the disputed ATM transaction through checking the E-journal right away if the disputed transaction takes place at an ATM belonging to the bank (internal dispute case). On the other hand, verification of external dispute cases could only be exercised through intermediate agent; EBS.

In external dispute cases, card issuing bank contacts EBS who will in turn send the disputed ATM transaction to acquirer bank (ATM owner bank).

4.1.4 Timeframe of ATM dispute resolution

At Faisal Islamic Bank, the end-to-end timeframe for internal dispute resolution is 24 hours of working days and that of external dispute resolution is 72 hours of working days. Faisal bank's working days are 6 days per week.

At Export Development Bank, internal and external ATM disputes approximately take 3 and 6 working days respectively. Export Development Bank's working days are 5 days per week.

At Faisal Islamic Bank, there is a dispute resolution department constructed for handling such transactions. On the other hand, DRP at headquarter of Export Development Bank are assigned to conduct other tasks in addition to ATM dispute resolutions.

4.1.5 Steps of internal dispute resolution

- i. DRP examine the details of disputed transactions on the E-journal.
- ii. DRP interpret the reason code of unsuccessful transaction.
- iii. Card issuing banks credit customer bank account if the disputed transaction is approved by the DRP.

4.1.6 Steps of external dispute resolution

- i. DRP contacts EBS in relation to the disputed ATM transaction.

- ii. EBS returns the disputed case to the acquirer bank which in turn verifies the disputed transaction through checking E-journal of the disputed ATM and responds to EBS.
- iii. EBS informs the card issuing bank about the feedback of the acquirer bank.
- iv. DRP at card issuing bank verify EBS feedback through checking the copy of E-journal of the acquirer annexed to EBS's feedback.
- v. If the EBS's feedback is approved by DRP at card issuing bank, the card issuing bank credits customer bank account after receiving the settlement file from EBS. Settlement file indicates that acquirer bank debits its account and credits card issuing bank through EBS.
- vi. If the EBS's feedback is disapproved by DRP at card issuing bank, the card issuing bank re-contacts EBS and requests re-checking of E-journal by acquirer bank. Disapproval of the feedback usually occurs if DRP misinterpret dispute reason codes whether at acquirer or card issuing bank.

Therefore, external dispute cases takes longer time to be resolved compared to internal cases as card issuing banks have to wait the feedback of EBS and receipt of settlement files. This extra-time is defined as Pend timeframe; the period of time when no further action could be taken by the card issuer since additional information is needed from ATM owner bank; acquirer bank. In case of disapproval of EBS's feedback by card issuing banks, the end-to-end timeframe of external dispute resolutions will be extended as card issuing banks re-contact EBS and request re-checking the E-journal of acquirer bank.

4.1.7 Communication of the dispute resolution result to bank customer

At Faisal Islamic Bank, bank customer receives information related to dispute resolution through SMS or direct call to customer's contact number. On the other hand, Export Development Bank does not have a clear policy for communicating the result of ATM resolution to its customers.

4.1.8 Costs of ATM dispute resolution

At both banks, DRP working at bank branches stated that the costs for ATM dispute resolution are one-day training course and 2 minutes to fill a dispute form provided all necessary

information are provided by cardholder. On the other hand, DRP working at headquarter banks explained that the costs for ATM dispute resolution are time and labour intensive.

4.1.9 Staff's proposed interventions for optimization of ATM resolution process

The following interventions were suggested to optimize ATM dispute resolution:

- Increase public awareness with regard to proper way of handling bank notes and executing ATM transactions as a preventive measure to decrease the incidence of disputed ATM transactions.
- Regular maintenance and filling of ATM machines to reduce incidences of ATM dispute.
- Assure uninterrupted internet and electricity supply to banking services to safeguard against occurrence of ATM dispute.
- Regarding Export Development Bank, the following measures have been suggested by bank employees in order to expedite ATM resolution process:
 - A staff member shall be solely assigned for dispute resolution. Currently, DRP are assigned to conduct other tasks in addition to dispute resolution.
 - Bank branches shall electronically submit dispute cases to headquarter rather than through the conventional internal circuit method.
 - Expanding venues through which customers could file a dispute case will improve customer satisfaction and relationship.

4.2 Analysis and discussion of the data:

4.2.1 Filing an ATM dispute case

Though submission of dispute ATM cases from bank branches to headquarter bank takes no longer than 24hrs at both banks, filing the dispute case is more convenient at Faisal Islamic bank compared to Export Development Bank due to following reason:

At Faisal Islamic Bank, filing dispute case could be conducted through several venues (customer service, SMS, and in person) whereas at Export Development Bank, cardholder has to present himself to the bank in order for the dispute case to be file.

Bank customers shall be able to file dispute cases through several venues. Expanding these venues will improve customer satisfaction and enhance loyalty. To further optimize dispute resolution process, filing dispute cases could be added to others services provided by banks to its customers through ATM or through its web-site. This service will enable customer to a file dispute case from anywhere, promote customer relationship, reduce repeated follow-ups from customers and relieve labor pressure related to dispute resolution. Nevertheless introduction of this service will increase the number of ATM transactions and hence add extra burden on an already busy server.

4.2.2 Determine ATM dispute category (Internal or External Dispute)

The financial banking system at Faisal Islamic Bank enables all DRP to determine whether the dispute is an internal or external issue irrespective to their work station (at Bank Branch or Headquarter Bank). On the other hand, DRP at Headquarter Export Development Bank could only determine whether the dispute is an internal or external issue.

Strengthening the financial banking system at Export Development Bank coupled with capacity building of dispute resolution staff working at its bank branches will enable DRP to determine the category of ATM dispute irrespective of their work stations.

4.2.3 Timeframe of ATM dispute resolution

4.2.3.1 Timeframe of internal dispute resolution

The end-to-end timeframe for internal dispute resolution is longer at Export Development Bank compared to Faisal Islamic Bank (72 hours and 24 hours respectively). Optimizing the resolution of internal dispute cases at Export Development Bank could be achieved through adoption of the following measures; electronic submission of internal dispute cases to headquarter bank rather than through the conventional internal circuit method.

A preventative measures to further optimize ATM dispute resolution; all banks shall be obliged to check their E-journals regularly, highlight all unsuccessful ATM transactions performed by their own customers and reverse them right away irrespective of whether the cardholder has filed an ATM dispute case or not. Central Bank of Sudan shall enact laws and

legislation directing national banks to resolve suspended resolution accounts on annual basis (zero bending or unresolved dispute case by the end of each fiscal year).

4.2.3.2 Timeframe of external dispute resolution:

The end-to-end timeframe of external dispute resolutions at both banks could be shortened through adoption of measures that minimize the Pend timeframe. The following measures are proposed to facilitate such goal:

- Feedbacks from both EBS and acquirer bank shall be provided within 24 hours.
- All banks shall be obliged to check their E-journals regularly for unsuccessful ATM transactions performed by an external customer (customer holding card issued by another bank), notify EBS and credit issuer bank straight away.

4.2.4 Communication of the dispute resolution result to bank customer

Faisal Islamic Bank has a clear policy for customer communication unlike Export Development Bank who does not. Notification of cardholder filing a dispute ATM transaction shall be a top priority for banks as it solidifies customer relationship and enhance loyalty. Therefore, all banks shall have a clear policy for customer communication to increase bank profits and boost customer retention.

4.2.5 Costs of ATM dispute resolution

The time and labour intensive costs of ATM dispute resolutions could be minimized if the below listed measures are implemented

- Strengthening DRP's technical expertise in handling dispute cases; particularly at bank branches, brings down operating costs of dispute resolution, lowers timeframe for ATM resolution, increases bank profits and enhances customer relationship.
- Regular checking of E-journals by DRP and rectification of all unsuccessful transactions whether a disputed ATM case has been filed or not. Such process could be facilitated through introduction of a new programme facilitating sorting out of all unsuccessful transactions in E-journals.

- Expanding venues through which cardholders could file a dispute case especially ATM, SMS, web-site and customer service will relieve labour pressure of dispute resolution and enhance customer satisfaction.

Customer satisfaction and loyalty could be further enhanced if financial banking system has been strengthened and risks and costs of ATM dispute resolution have been minimized through successful implementation of both preventive and corrective measures mentioned earlier.

4.3 Proper Venues

Providing multi venues will facilitate the process of filling and querying of dispute case. Venues could be through customer care, SMS, web-site and through ATM. Banks with leadership of EBS should come to a deal with software vendors to provide filing dispute and query dispute as fundamental services as well as cash withdrawal and check balance. With integration to others financial system this venue will reduce operational cost (documentation of files, offices, hiring of employees, electricity, computers etc), reduce labor pressure and time frame of dispute resolution. From this venue a copy of filing dispute details should be send to EBS and the acquire bank (external dispute). EBS shall oversee the resolution process of any dispute (internal or external).

4.3.1 Analysis for proper venue

Use of Unified Modeling Language for analysis to these proper venues for filling and dispute ATM will reduces time and cost for development, easy to add any changes and easy to follow cause it has many diagrams

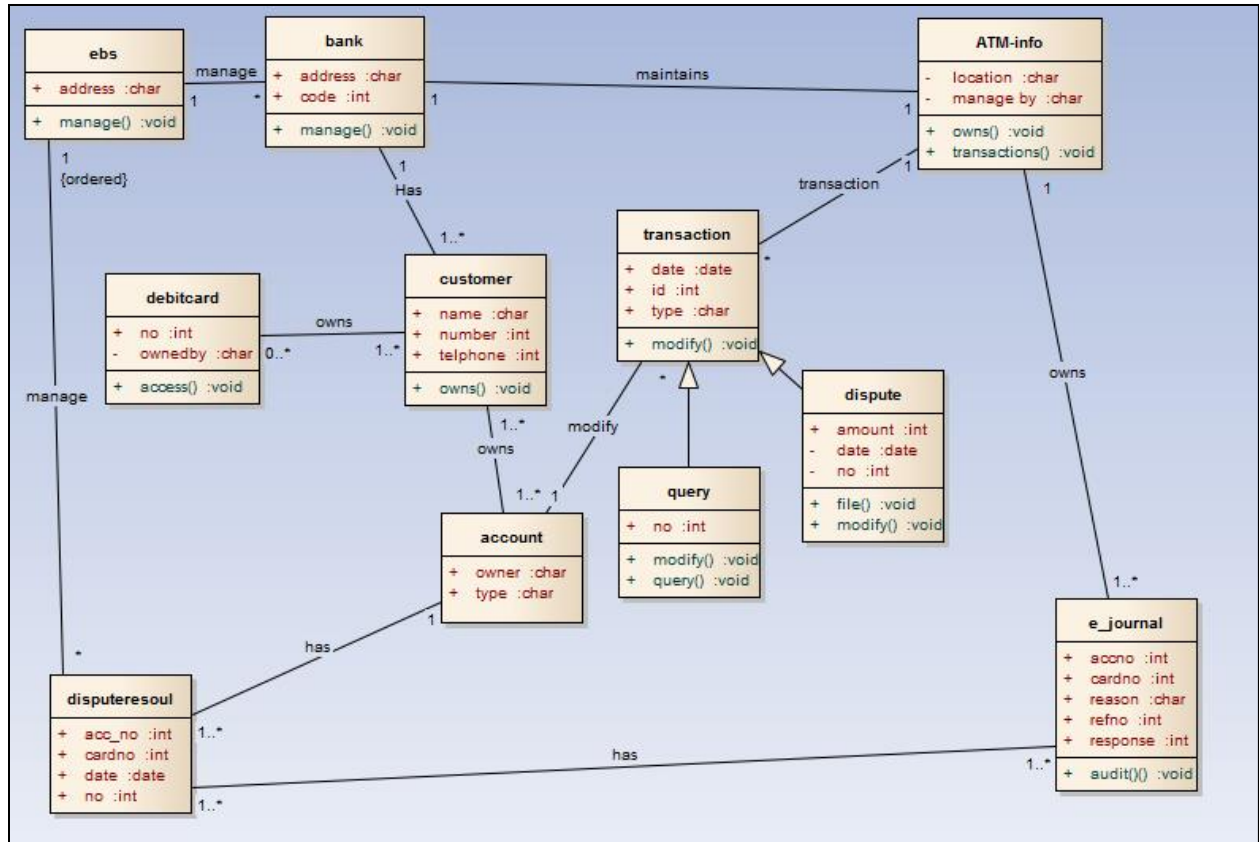

Figure3: Dispute resolution class diagram

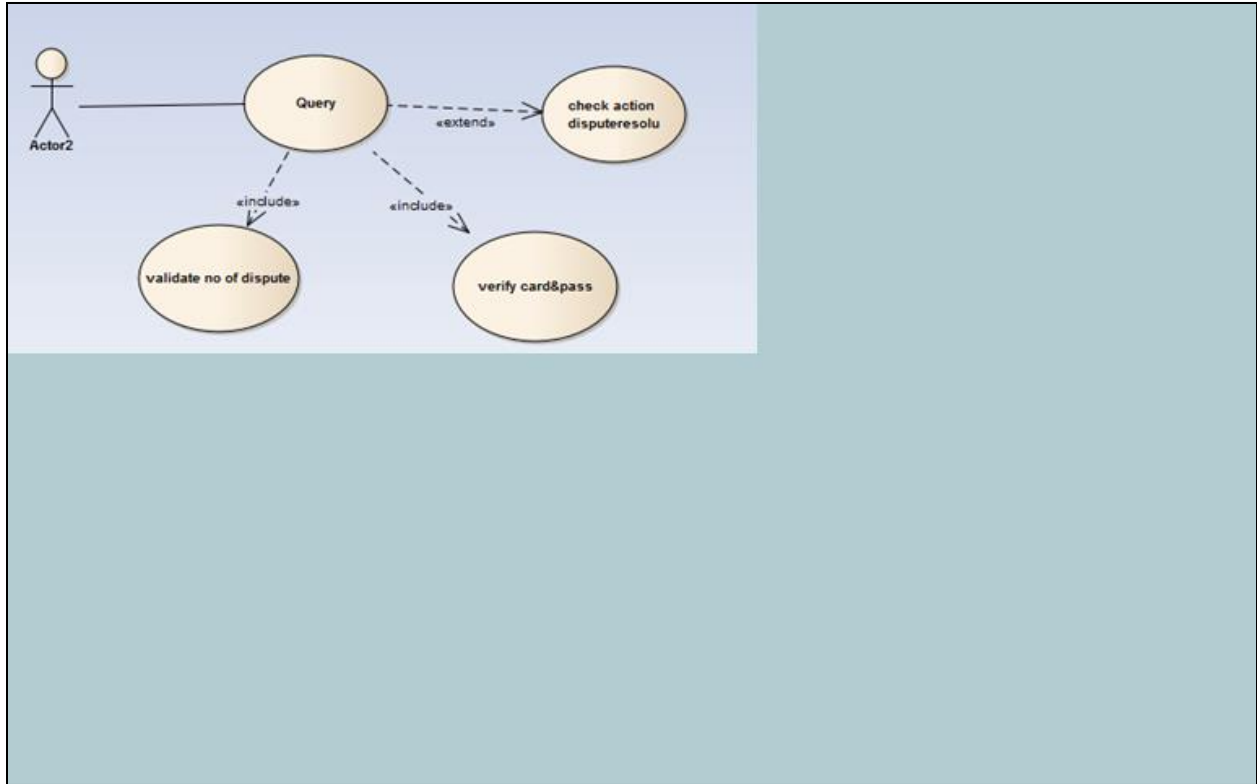

Figure 4: Query use case diagram

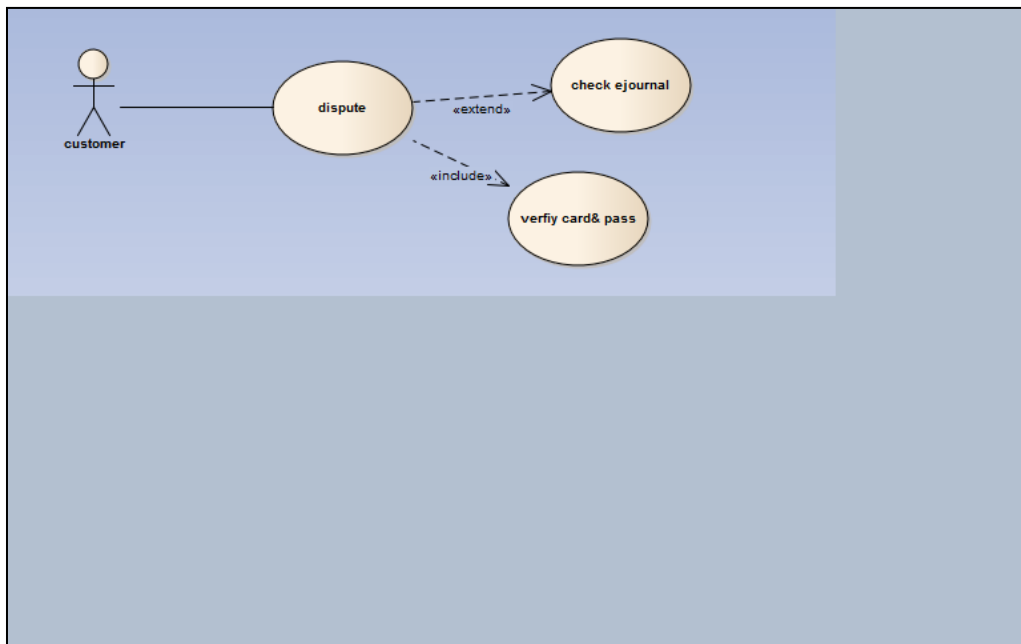

Figure 5: File dispute ATM use case diagram

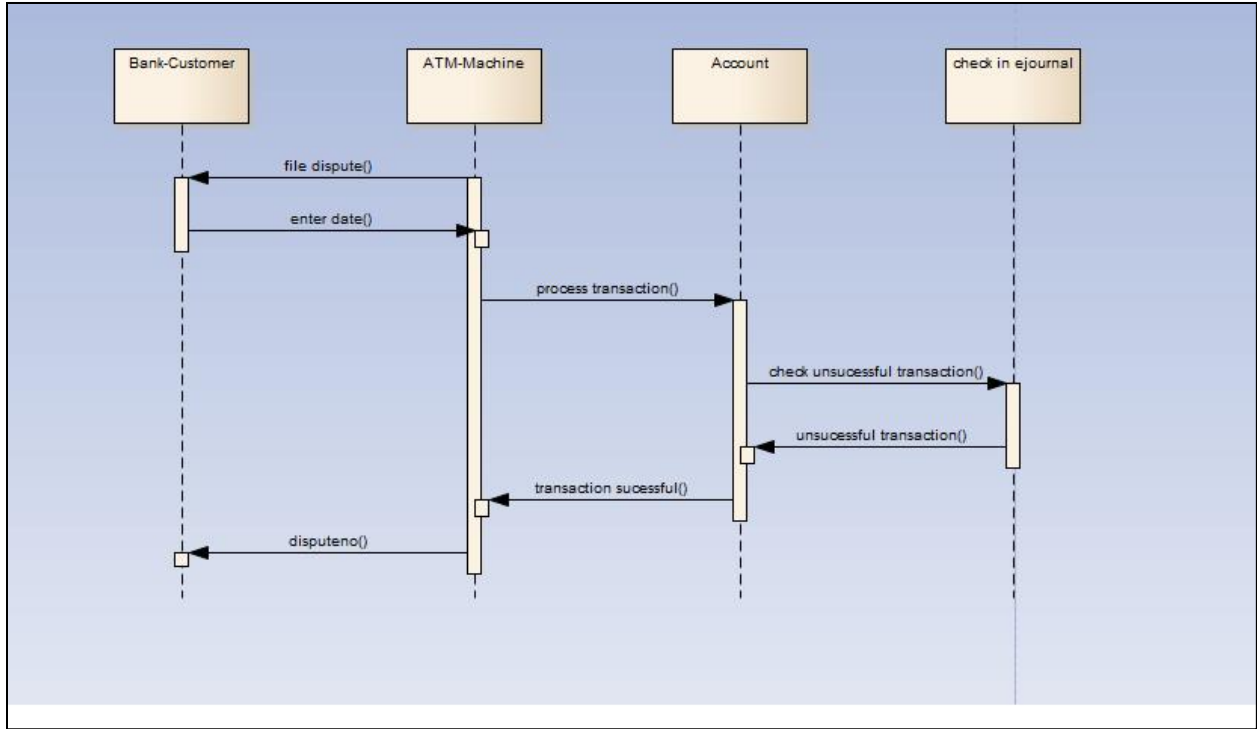

Figure 6: File Dispute ATM sequence diagram

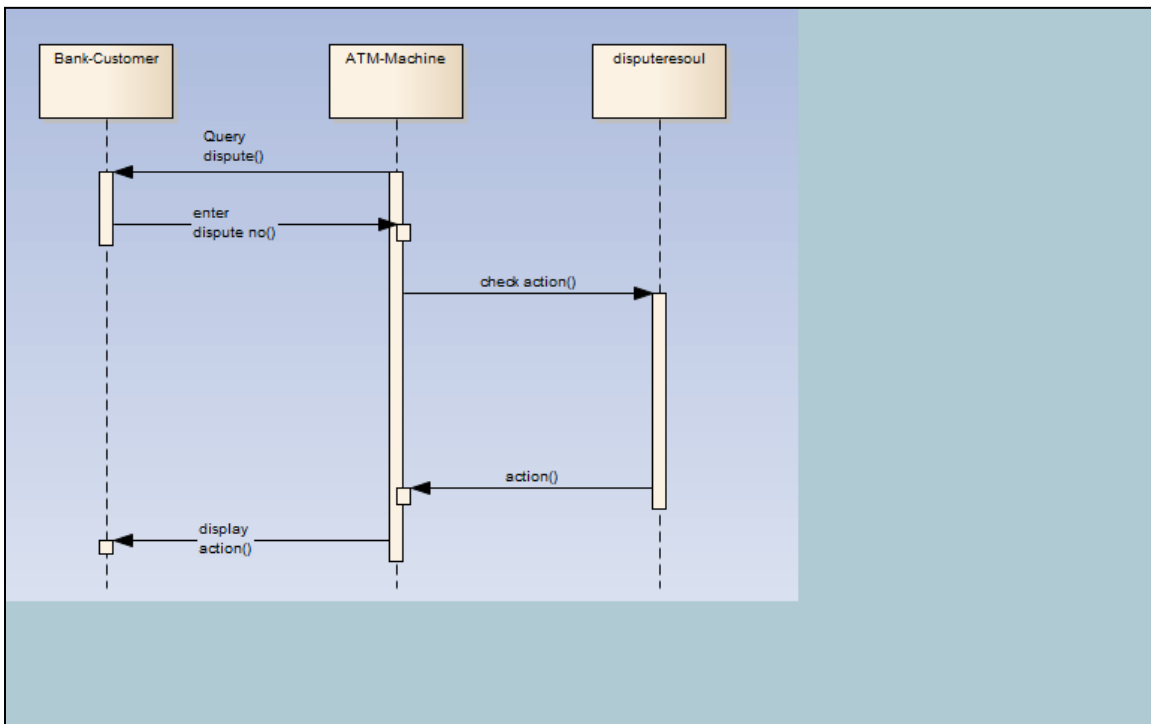

Figure 7: Query dispute sequence diagram

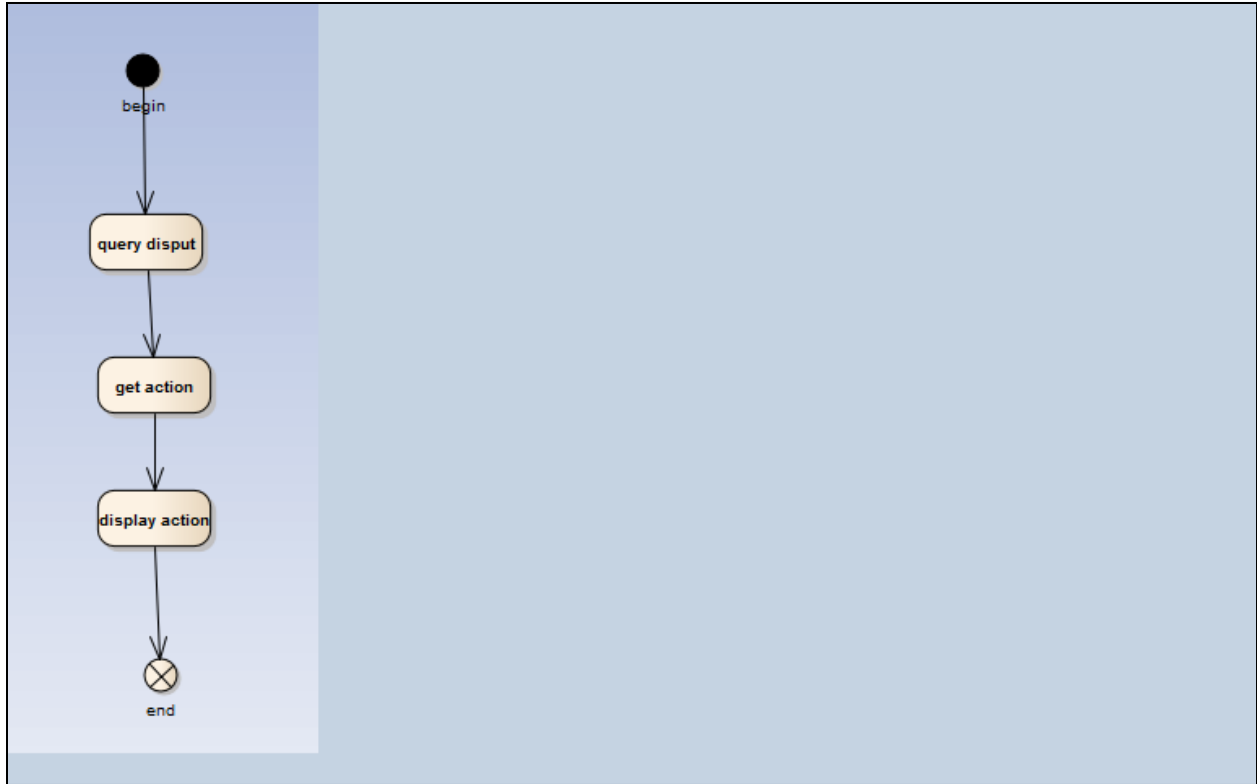

Figure 8: Query dispute activity diagram

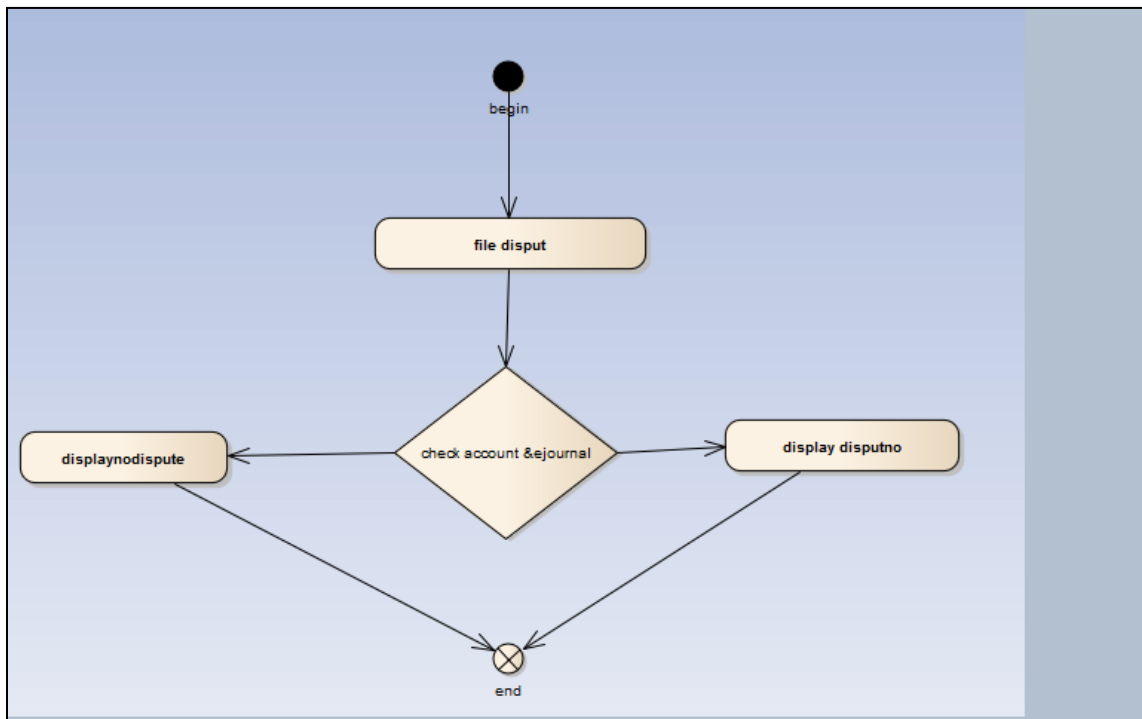

Figure 9: File dispute ATM activity diagram

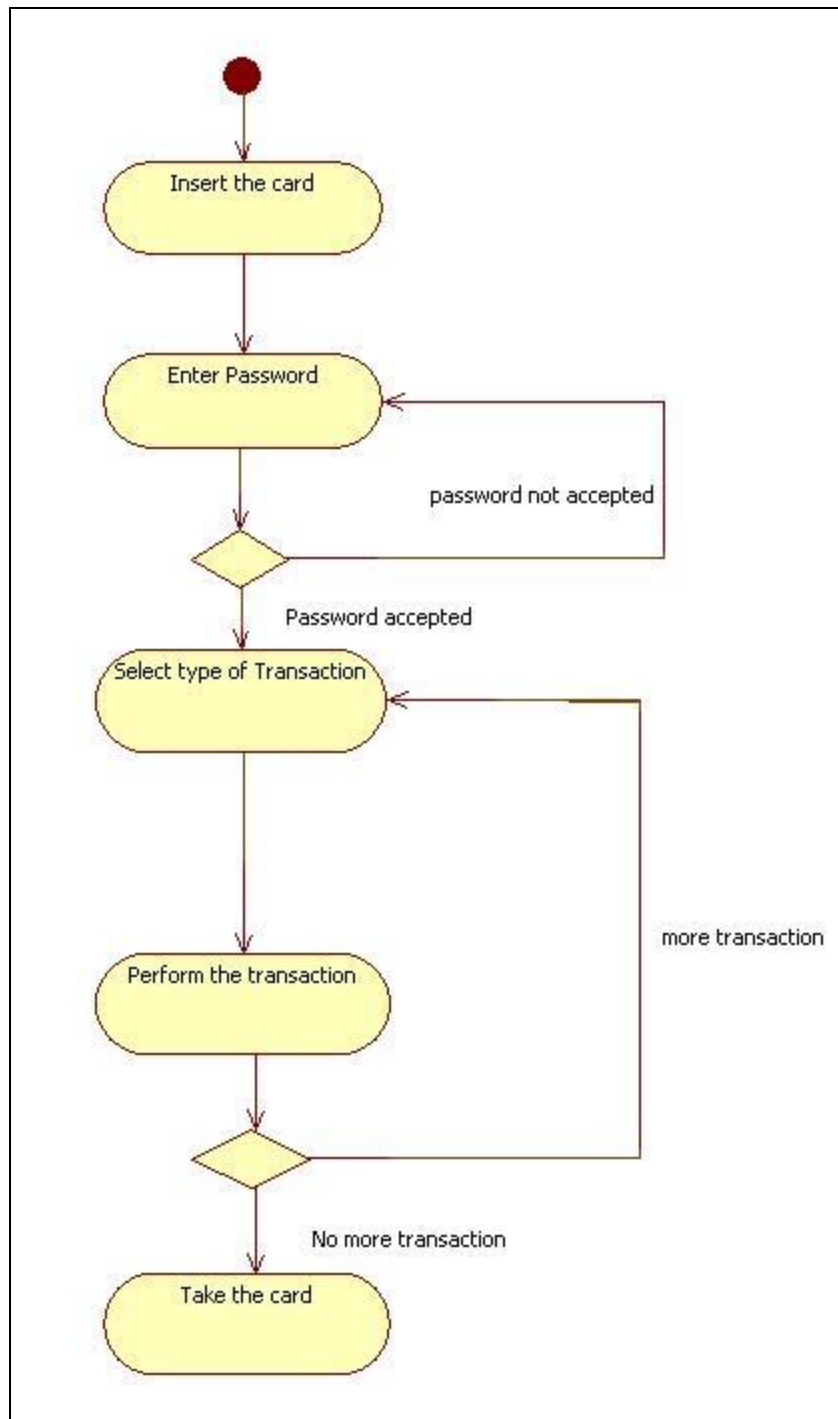

Figure 10: Activity diagram for all ATM transaction

4.3.2 Screen for proper venue

4.3.2 .1 Screen for filing and query dispute ATM through ATM



Figure 11: Services screen

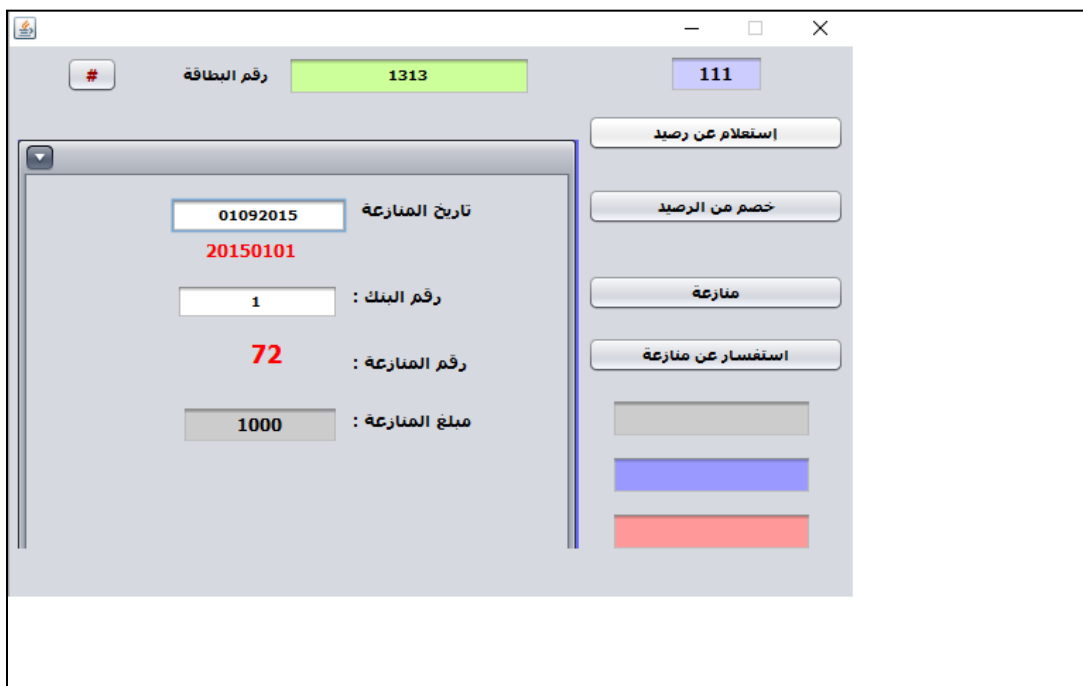

Figure 12: File Dispute screen



Figure 13: Dispute resolution screen

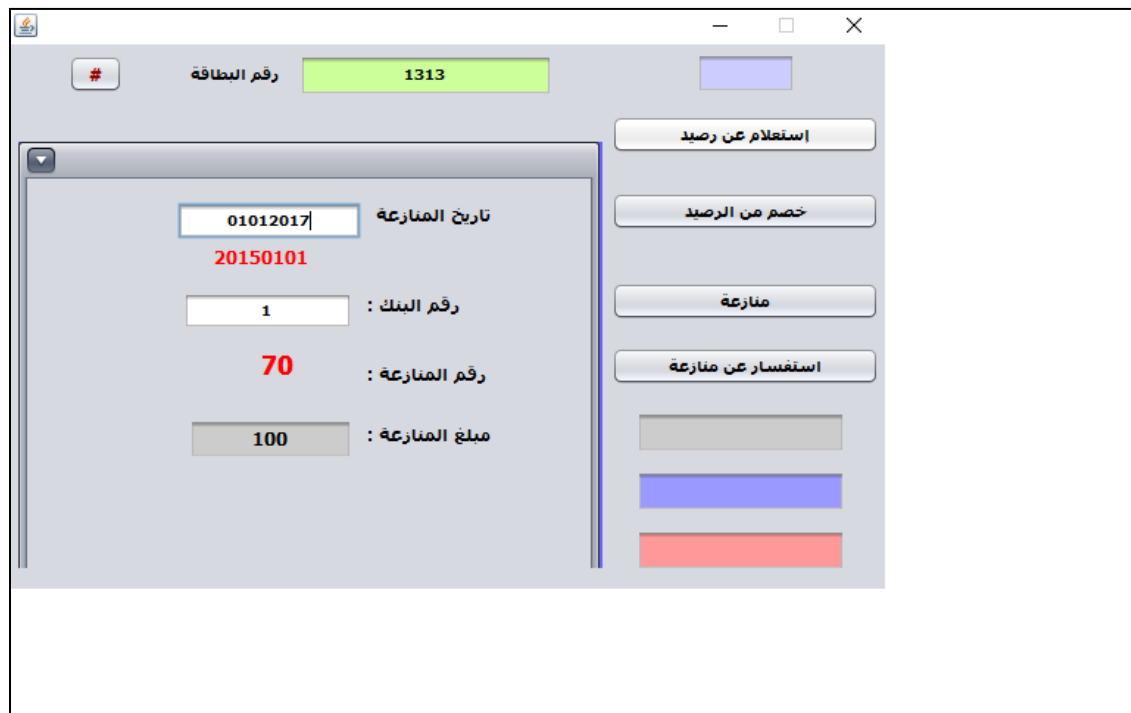

Figure 14: Query Dispute Screen

4.3.2.2 Screen for web site venue

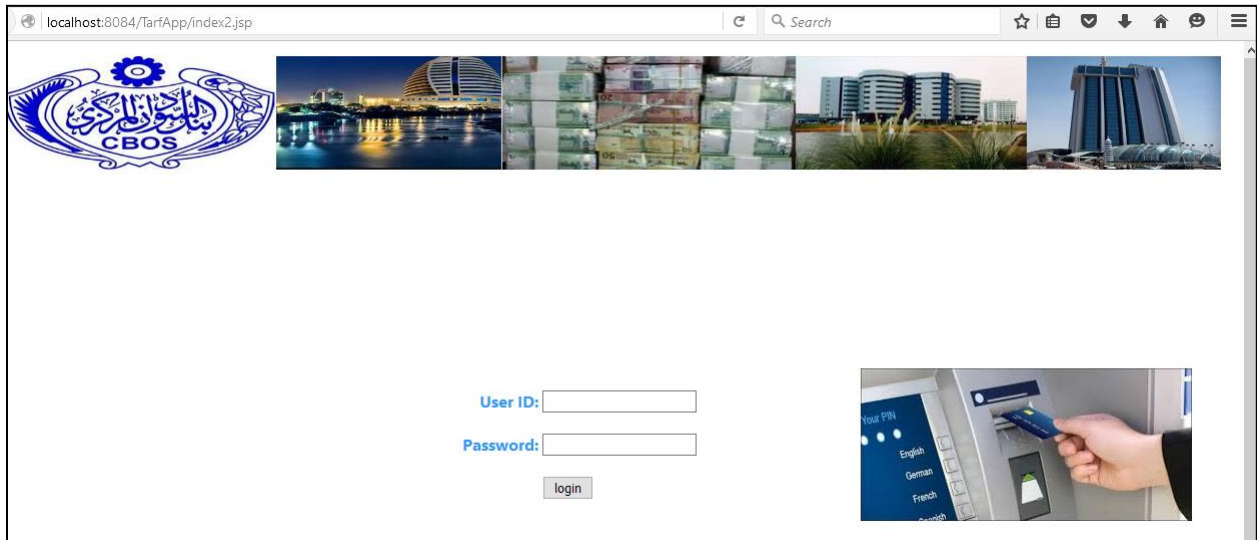

Figure 15: Login Screen

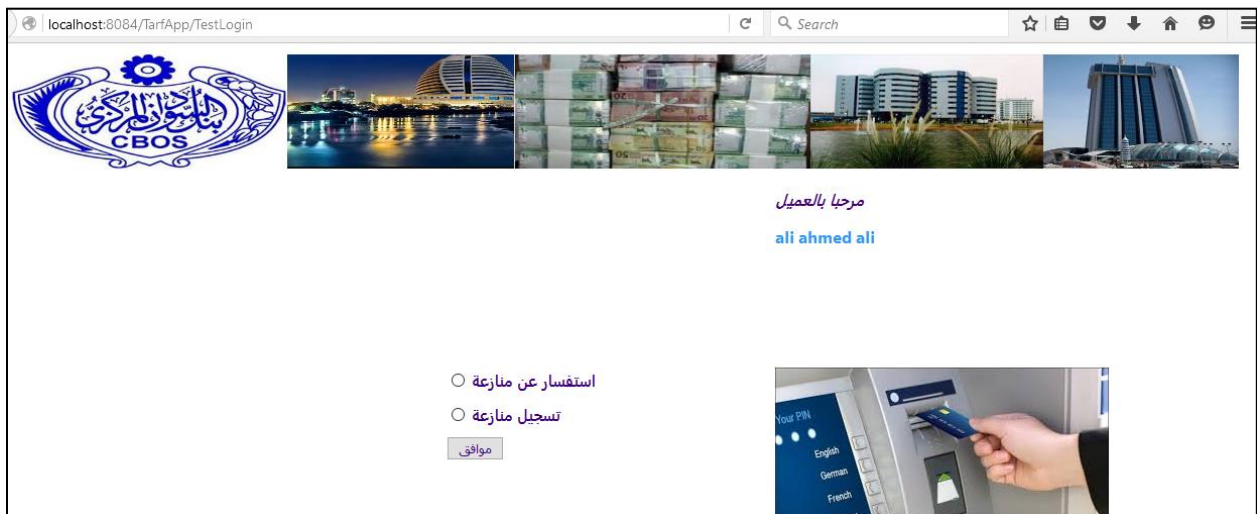

Figure 16: Services Screen

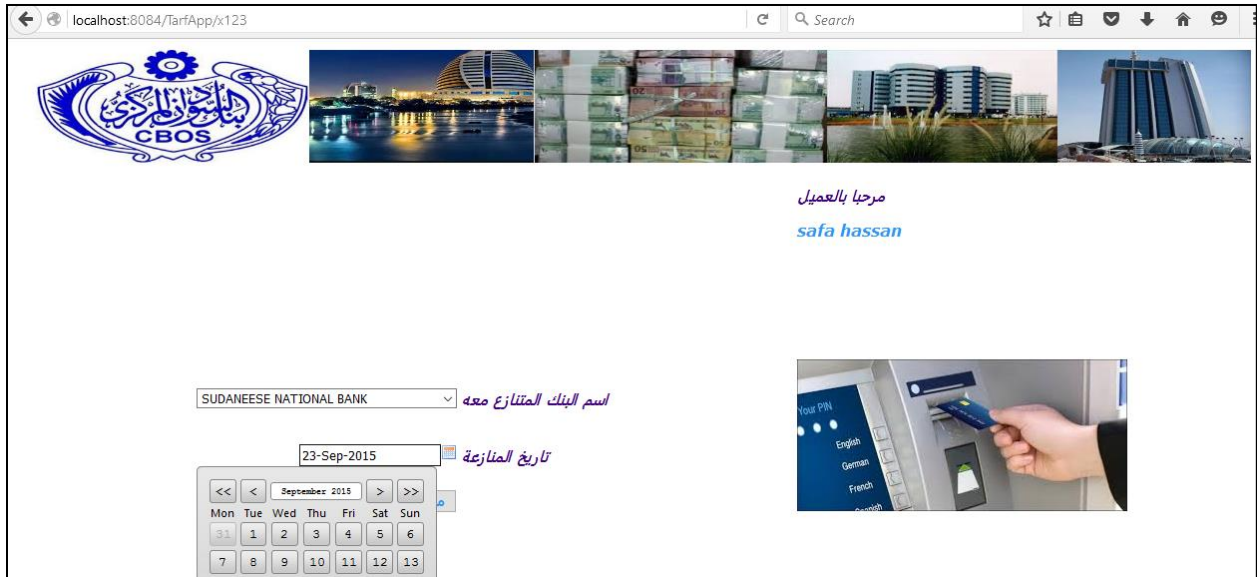

Figure 17: File Dispute screen

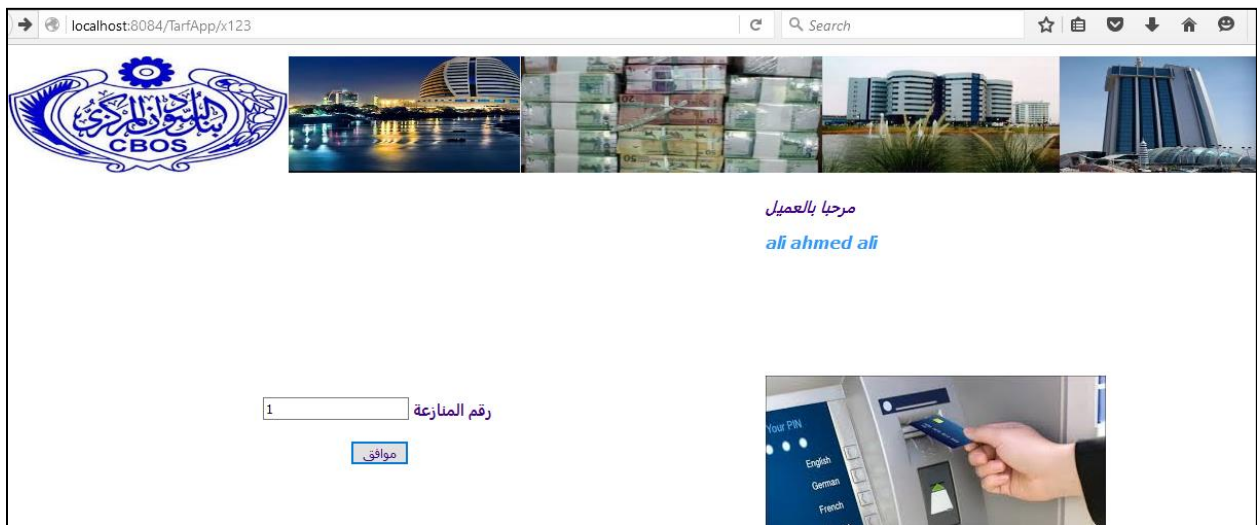

Figure 18: Query Dispute Screen

Chapter Five

Conclusion, Recommendation and Future research

5.1 Conclusions

To endure a competitive environment in financial banking system, banks strive to improve the effectiveness and efficiency of ATM dispute resolution process in order to decrease its operational costs and enhance customer relationship and loyalty. Rectification of bottlenecks in ATM resolution process and adoption of innovative preventive measures and interventions will potentially decrease the risks of unsuccessful ATM transactions and optimize dispute resolution process.

5.1.1 Bottlenecks in ATM dispute resolutions

Bottle necks in ATM are as listed below

1. Filing of dispute case (inconvenient filing venues to bank customers)
2. Inadequate competency of DRP in handling ATM dispute cases especially in interpreting dispute reason codes.
3. Prolonged Pend timeframe
4. Poor technology of ATM services (interrupted electricity supply and internet connection increase the risks of unsuccessful transactions and hence the rate of filing dispute ATM cases).

5.1.2 Strategic levers

Strategic levers are recommended for optimizing ATM dispute resolution as below

1. Expanding venues through which customers could file ATM dispute case (customers shall be able to file ATM dispute via telephone call, fax, E-mail or in person at any bank branch 24hrs a day 7 days a week.
2. Strengthening DRP's technical expertise in handling dispute cases to lower the end-to-end timeframe for ATM dispute resolution.
3. Increase public awareness on E-Banking services and proper use of ATM machine along with regular maintenance and feeding of ATM will reduce the risks of unsuccessful ATM transactions and decrease incidences of dispute cases.
4. Advocating for enactment of laws and legislation by Central Bank of Sudan that oblige all Sudanese Banks to perform regular checking of E-journals and rectification of all

unsuccessful ATM transactions whether a dispute case has been filed or not will bring down the operational costs of dispute resolution process.

5.2 Recommendations

1. EBS shall oversee the resolution process of all disputed transactions (internal dispute cases as well as external dispute cases).
2. Central Bank of Sudan shall enact laws and legislation directing national banks to resolve suspended resolution accounts on regular basis (zero bending / unresolved dispute cases). Zero bending / unresolved dispute cases shall be a pre-requisite for renewal of accreditation certificate of banking services.
3. The feasibility of National investment in ATM E-banking system: Such a measure will potentially lead to production of ATMs that fits more to our local context (interrupted electricity supply and internet connection).
4. EBS should ensure that filling and resolution of dispute case through ATM or website should include procedures that safeguard cardholder personal data

5.3 Further research

Further research shall be conducted to investigate the following points:

1. Assessment of customers' point of view in relation to dispute resolution to further optimize E-banking services.
2. Integration of dispute management system with the rest of financial banking system (camera monitoring systems and accounting departments) to optimize dispute resolution process and ultimately decrease end-to-end resolution timeframe and enhance customer satisfaction.

References

1- Norazah Mohd Suki, An Empirical Study of Factors Affecting the Internet Banking Adoption among Malaysian Consumers.

2- Wikipedia. Automated teller Machine.

https://en.wikipedia.org/wiki/Automated_teller_machine, [cited 2015 Jan 5]

3- Prineta. Recent post. <https://prineta.com/atm-dispute/> .[cited 2015 Feb 20].

4- سوداراس الاقتصادية

<http://www.sudaress.com/alsudani/23235>, [cited 2015 Feb 18]

5- Tom Cain, Risky Business: Best Practices for Managing Cardholder Dispute and Chargeback Processes in Challenging Times, TSYS

6- Sumit Sood, Joseph Pinipe, Card disputes and charge backs: Improving customer experience while reducing costs, WIPRO

7- ايمان العاني, البنوك التجارية وتحديات التجارة العالمية ، رسالة ماجستير في العلوم الاقتصادية ، جامعة منتوري ، كلية العلوم الاقتصادية وعلوم التسيير ، قسنطينة ، الجزائر

8- Central bank of Sudan, towards a modern and dynamic central bank

<http://www.cbos.gov.sd/en/node/413> [cited 2015 FEB 8]

9- Central bank of Sudan, the main objectives of the CBOS

<http://www.cbos.gov.sd/en/node/110> [cited 2015 FEB 8]

10- EBS

<https://www.ebs-sd.com/en/ebs-history.php> [cited 2015 FEB 8]

11- EBS

<https://www.ebs-sd.com/en/vision-and-mission.php> [cited 2015 FEB 8]

12- EBS, National Switch Center

<https://www.ebs-sd.com/en/national-switch-center.php> [cited 2015 FEB 8]

13- Financial-ombudsman service, Publication. On line technical resource. http://www.financial-ombudsman.org.uk/publications/technical_notes/disputed-transactions.htm [cited 2015 Jan 5]

14- Steven J Murdoch, RELIABILITY OF CHIP & PIN EVIDENCE IN BANKING DISPUTES, 2009

15- Electronic Journal (EJ) Manager Centralized retrieval and management

16- Why “Everyone Wins” When Issuers and Merchants Collaborate

[http://www. Verifi.com/](http://www.Verifi.com/) [cited 2015 FEB 12]

17- Balamurugan Soundararajan, Four Effective Ways to Optimize the Credit Card Dispute Resolution Process, Tata Consultancy Services

18- Faisal Islamic Bank (Sudan), about FIBS basic information

http://www.fibsudan.com/en_3/?bg=aboutBank&contentID=23 [cited 2015 JUN 12]

19- Export Development Bank

<http://www.edbank.sd/> [cited 2015 December 2]

APPENDICES

Appendix (1)

Cash taken

```
*TRANSACTION START*
-[020t CARD INSERTED
-[020t 09:19:27 PIN ENTERED
-[020t 09:19:49 NOTES STACKED
-[020t 09:19:51 CARD TAKEN
-[020t 09:19:55 NOTES TAKEN
-[020t 09:19:55 NOTES PRESENTED 0,38,0,1
-(1-----
WITHDRAWAL *****
07.04.17 09:21
AMOUNT :      810.00 SDG
RESPONSE :1
TRANSACTION COMPLETED
RETRIEVAL REFERENCE NUMBER *****
-----
-[020t 09:20:11 TRANSACTION END
```

Appendix (2)

Retracted

```
19:43:05 -> TRANSACTION START
19:43:41 CASH PRESENTED
-----
WITHDRAWAL XXXXXXXXXXXXX
11.04.17 19:44
AMOUNT : 450.00 SDG
RESPONSE :1
TRANSACTION COMPLETED
RETRIEVAL REFERENCE NUMBER XXXXXX
-----
*505*19:44:26 CASH PRESENT TIMER EXPIRED
*506*19:44:42 CASH RETRACTED
19:44:42 DEVICE CCCdmFw STATUS 2 SUPPLY 1
19:44:47 <- TRANSACTION END
```

Appendix (3)

Timeout

```
-(1-----  
WITHDRAWAL *****  
04.04.17 16:58  
AMOUNT : 1000.00 SDG  
RESPONSE :1  
TIMEOUT  
RETRIEVAL REFERENCE NUMBER *****  
-----  
-[020t 16:57:56 CARD TAKEN  
-[020t 16:58:00 TRANSACTION END  
|
```

Appendix (4)

Impossible to process

```
14:36:21 TRANSACTION REQUEST ADC C B
14:36:52 TRANSACTION REPLY NEXT 158 FUNCTION 5000
-----
WITHDRAWAL XXXXXXXXXXXXX
12.03.17 14:38
AMOUNT :      850.00 SDG
RESPONSE :72
IMPOSSIBLE TO PROCESS
RETRIEVAL REFERENCE NUMBER XXXXXX
-----
14:36:54 CARD(XXXXXXXXXXXX) TAKEN
14:36:57 <- TRANSACTION END
```