



Sudan University of Science and Technology



Collage of Graduate Studies

Collage of Computer Science and Information Technology

**THREE DIMENSIONAL MODELING WITH DESIGN TEXTURE
MAPPING FOR SUDAN UNIVERSITY OF SCIENCE AND
TECHNOLOGY**

نمذجة ثلاثية الأبعاد مع خريطة تصميم الملمس لجامعة السودان للعلوم
والتكنولوجيا

BY

MAARIB AHMED ALTIGANY MOHAMMED ALMOKHTAR

*A Thesis Submitted in Partial Fulfillment of the Requirements of
Master Degree in Computer science
(GIS Geographical Information Systems)*

Supervisor

Prof. Dr.-Ing. DIETER FRITSCH

July 2016

الآية



﴿ يَرْفَعِ اللَّهُ الَّذِينَ آمَنُوا مِنْكُمْ وَالَّذِينَ أُوتُوا الْعِلْمَ دَرَجَاتٍ ﴾

سورة المجادلة الآية -11-

DIDICATION

This thesis dedicated to my parents, husband, brothers and sisters

For their endless love, support and encouragement

ACKNOWLEDGEMENTS

First and foremost, I have to thank my parent for their love and support throughout my life. Thank you both for giving me strength to reach for the stars and chase my dream. My sisters, brothers, auntie and cousins deserve my wholehearted thanks as well.

I would like to sincerely thank my husband for his efforts and support throughout this study, and especially for his confidence in me.

I would also like to thank my supervisor Prof. Dieter, in special way, I express my heartfelt gratefulness for his guide and support that I believed I learned from the best.

Thank you for always being there for me.

ABSTRACT

According to the great urban progress in the country and permanent renewal of buildings in line with modern developments an update of 3D building infrastructures becomes a necessity. Especially university buildings are of main concern, which are changing continuously as well as offices and lecture halls according to the requirements of the university and by adding new buildings. Students are suffering for knowing places of offices, lecture halls and how to reach it, especially the new students during the registration period, who are wasting their time in asking off a way to reach a particular place inside the university. This could affect negatively on their lecture times or the completion of registration procedure in time. Starting off from that point, different ideas and techniques grew up to make the geographic orientation easier for students and guiding them to reach a particular place in due time. For this reason, the need of applying three-dimensional visualizations with texture mapping is the true simulation of reality- this is called Virtual Reality Model (VRM). On the other hand, this thesis aims to take advantages of GIS environment to offer a flexible interactive system for providing the best visual interpretation, planning and decision making processes for SUSTECH.

المستخلص

نسبة للتطور العمراني المشهود في الآونة الأخيرة والتجديد الدائم للمباني بما يناسب التقدم الحديث، خاصة بمباني الجامعات مثل القاعات والمكاتب بما يستلزم المتطلبات الجامعية بتجديد واضافه مباني ، اصبح لابد من توفر بنية ثلاثية الأبعاد لتوضيح تلك المباني. يعاني الطلاب وخاصة الطلاب الجدد، من صعوبة معرفة اماكن المكاتب والقاعات وكيفية الوصول اليها خاصة في فترة التسجيل. يهدر الطالب الوقت بالسؤال عن طريق الوصول الى مكان معين داخل الجامعة مما قد يؤثر سلبا على زمن وصوله للمحاضرات او اكمال إجراءات التسجيل في الوقت المحدد. انطلاقاً من ذلك نشأت افكار وتقنيات مختلفة للتسهيل على الطالب للوصول للأماكن المراده في الوقت المحدد.لذلك ومن هنا ظهرت الحاجة لتطبيق الخرائط والنماذج التصويرية ثلاثية الابعاد وهي محاكاة حقيقيه للواقع والتي تعرف بـ (VRM) . من ناحية اخرى يهدف البحث للاستفاده من انظمة المعلومات الجغرافيه(GIS) في توفير بيئه تفاعلية مرنة لتقديم افضل نموذج تصويري لجامعة السودان للعلوم والتكنولوجيا للاستفسارات والتخطيط والمساهمة في اتخاذ القرار .

LIST OF CONTENTS

الآية

Dedication

Acknowledgment

Abstract.....I

المستخلص.....II

List of contentIII

List of figures.....V

List of abbreviations.....VII

1. INTRODUCTION

1.1 Overview.....1

1.2 Problem Statements.....1

1.3 Research Hypothesis.....2

1.4 Research Objectives.....2

1.5 Research Significance.....4

1.6 Thesis Layout.....5

2. RELATED WORK AND LITERATURE REVIEW

2.1 Theoretical Framework.....6

2.1.1 Computer Graphics6

2.1.2 Geographic Information Systems (GIS).....6

2.1.3 Photogrammetry.....8

2.1.4 RGB-D Mapping.....11

2.2 Literature Review.....14

2.3 Proposed system description.....20

2.3.1 Current System.....20

2.3.2 Current System Problems.....20

2.3.3 Proposed solutions20

2.3.4 Proposed System Description.....21

2.3.5 Scope of system.....21

2.3.6 Proposed System Problems.....21

3. METHODOLOGY AND RESEARCH PLANNING

3.1 Research community.....22

3.2 Methodology and Research Planning.....22

3.3 Selected methodology and techniques.....25

4. SYSTEM ANALYSIS AND DESIGN	
4.1 System Requirements.....	27
4.1.1 Functional Requirements.....	27
4.1.2 Technical Requirements.....	27
4.1.3 Nonfunctional Requirements	28
4.2 Analysis and Design.....	28
4.2.1 Database Requirements	28
4.2.2 Database Design.....	29
5. SIMULATIONS AND RESULTS	
5.1 Photogrammetry	34
5.2 3D Model Reconstruction.....	37
6. CONCLUSIONS AND OUTLOOK	
6.1 Conclusions.....	46
6.2 Recommendations	46
7. REFERENCES.....	47

LIST OF FIGURES

Fig.NO	Description	page
1.1	Three-dimensional acquisition systems for object measurement using non-contact methods based on light waves.	3
2.1	(a) 3D Reconstruction of a bridge	6
	(b) 3D Reconstruction of a building	6
2.2	Functional component of GIS.	7
2.3	An example of map layers used altogether in GIS.	7
2.4	Photogrammetry portrayed as a systems approach. The input is usually referred to as data acquisition, the “black box” involves photogrammetric procedures and instruments, the output comprises photogrammetric products.	8
2.5	Classification of sensing devices.	10
2.6	(a) aerial cameras Aviophoto RC20 from Leica.	10
	(b) Angular coverage, photo scale and ground coverage of camera.	10
2.7	(left) RGB image and (right) depth information captured by an RGB-D camera.	11
2.8	The 3D Mapping Process	12
2.9	Classification schema: Sources, Modeling, Visualization.	17
2.10	(A),(B),(C) Prototype models of 3D visualization.	19
4.1	SUSTECH Campus Geodatabase Schema.	30
4.2	GIS Layer Structure and Hierarchy.	31
4.3	The workflow to build a 3D model.	31
4.4	Schematic diagram of the methodology study scenario to build a 3D data campus model.	33

Fig.NO	Description	Page
5.1	Several Photos “scanning” the College of Computer Science and Information Technology.	35
5.2	An Aerial Photo Excerpt illustrating the Geographical Location of SUSTECH.	35
5.3	AgiSoft Image Processing: (A): illustrating aligning photos and detecting points. (B): illustrating dense image matching. (C): showing the point clouds. (D): dense model of point clouds points. (E): soled model of faculty of CSIT.	36
5.4	(A),(B) Using SketchUp with Undet Extension for Model Reconstruction and Refining for CSIT.	37
5.5	Image Texture for Faculty of Applied Arts.	38
5.6	Captured Images for Texture Mapping illustrating Paintings, Sculptures and Arabic Font Art from the Faculty of Applied Arts	39
5.7	Final SketchUp result for SUSTECH 3D Model form different views	39
5.8	The main model’s layers (A) 3D Layer. (B) Buildings Layer. (C) Colleges Layer.	40
5.9	(A) Coordinate System Specification. (B) Three main layers’ shapefiles	41
5.10	(A) Layer’s Attribute Tables. (B) Layering Process.	41
5.11	Shows Various Types of Queries for SUSTECH VRM with Texture and Geodata.	44
5.12	Fig.5.12 VR view on sketchfap viewer.	54

LIST OF ABBREVIATIONS

Abbreviation	Definition
SUSTECH	Sudan university of science and technology
CSIT	Computer science and Information Technology
VRM	Virtual Reality Model
VR	Virtual Reality
GIS	Geographic Information Systems
LiDAR	Light Detection And Ranging
webGL	Web Graphics Library
LAS	Leaser
COTS	Commercial Of The Shelf

Chapter 1

Introduction

- 1.1 Overview
- 1.2 Problem Statements
- 1.3 Research Hypothesis
- 1.4 Research Objectives
- 1.5 Research Significance

1.1 Overview

Three-dimensional visualization with texture mapping is the true simulation of reality, especially if it is relatively accurate. The current off-the-shelf software products facilitate constructing 3D models by existence of flexible GIS environments.

Several methodologies are used to build up 3D virtual reality models with dissimilar accuracies and applied techniques. One way to obtain such data is to let skillful workers create building models manually based on building blueprints, aerial and terrestrial images and other data sources.

This solution, however, requires a large amount of manual work, thus it is both slow and expensive. Photogrammetry provides a 3D point cloud, which samples the surface of an urban site in an accurate and fast approach, and on the other hand, 3D GIS models provide the best analysis options and decision making processes.

The SUSTECH main campus has a vaulty region, comprises numerous collages and administrative buildings. The essential objective of this work is to use photogrammetry to provide high precision visualization of the interested area and also to help students and visitors to access the model remotely from anywhere and anytime via desktops or smartphones platforms.

1.2 Problem Statements

This project will provide answers to the following questions showing the research problem:

- What is the requirement of designing a system or application representing the geographical locations in a three-dimensional style for buildings of SUSTECH?
- What are the goals and the importance of designing a system and/or applications representing the geographical areas in a three-dimensional model?
- What about the impact and contribution of applying the system for the students of SUSTECH?
- What are the prominent landmarks of the university, and locations of libraries, laboratories, offices of professors, supervisors, departments of colleges and lecture halls?
- What is the scope of applying the system?
- What are the obstacles and difficulties that hinder the system to work properly?

1.3 Research Hypotheses

The following research hypotheses are formulated:

- Due to continuous improvements in university buildings it is necessary to have a map showing the basic parameters and the definition of buildings in the university, according to the progress of modern technology in photogrammetry and geographical information systems.
- The System provides a three-dimensional design of all buildings for SUSTECH and shows all colleges, landmarks, and individual buildings associated with semantic information.
- The university allows the student to use its resources such as lecture halls, laboratories, offices, libraries and cafeterias and other resources. The system facilitates access of those resources and provides some information about it.

1.4 Research Objectives

- The main purpose of this research is to understand the benefits of utilizing interactive, three-dimensional (3D) visualization by designing a 3D model for SUSTECH to assist students and visitors when they need to reach a place inside the university.
- Provides information about all resources inside the university when students make location queries and guides him/her to the right direction.
- Another objective in this study is to explore the capabilities of current technology of photogrammetry and software such as ArcGIS to link the spatial information about the building features and utilities within the map which helps on making decisions.

1.4.1 Three-dimensional (3D) Modeling

Three-dimensional modeling of an object can be seen as the complete process that starts from data acquisition and ends with a 3D virtual reality model visually interactive on a computer. Often 3D modeling is meant only as the process of converting a measured point cloud into a triangulated network (“mesh”) or textured surface, while it should describe a more complete and general process of object reconstruction. Three-dimensional digital models are required in many applications such as inspection, navigation, object identification, visualization and animation. The most general classification of 3D object measurement and reconstruction techniques can be divided into contact methods (for example, using coordinate measuring machines, calipers, rulers and/or bearings) and non-contact methods (X-ray, photogrammetry, laser Scanning).

Nowadays the generation of a 3D model is mainly achieved using non-contact systems based on light waves, in particular using active or passive sensors (Fig. 1). [8]

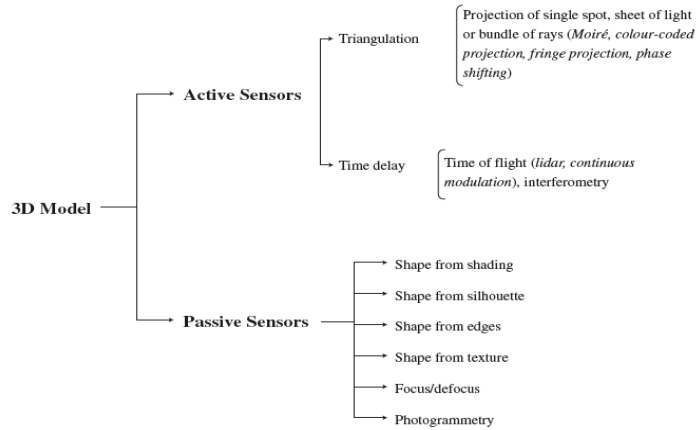

Fig. 1.1 Three-dimensional acquisition systems for object measurement using non-contact methods based on light waves. [8]

There are four alternative methods for object and scene modeling:

(1) Image-based rendering (IBR)

This does not include the generation of a geometric 3D model but for particular objects and under specific camera motions and scene conditions IBR creates novel views of 3D environments directly from input images. The technique relies on either accurately knowing the camera positions or performing automatic stereo matching that, in the absence of geometric data, requires a large number of closely spaced images to succeed. Object occlusions and discontinuities, particularly in large-scale and geometrically complex environments, will affect the output. The ability to move freely into the scene and view objects from any position may be limited depending on the method used. Therefore, the IBR method is generally only used for applications requiring limited visualization. [8]

(2) Image-based modeling (IBM)

This is the widely used method for geometric surfaces of architectural objects or for precise terrain and city modeling IBM methods (including photogrammetry) use 2D image measurements (correspondences) to recover 3D object information through a mathematical model or they obtain 3D data using methods such as shape-from-shading, shape-from-texture, shape-from-contour (medical applications) and shape-from-2D edge gradients. Passive image-based methods acquire 3D measurements from multiple views, although techniques to acquire three dimensions from single images are also available. They are very portable and the sensors are often low-cost. [8]

(3) Range-based modeling

This method directly captures the 3D geometric information of an object. It is based on costly (at least for now) active sensors and can provide a highly detailed and accurate representation of most shapes. The sensors rely on artificial lights or pattern projection. These sensors are still expensive, designed for specific ranges or applications and they are affected by the reflective characteristics of the surface.

They require some expertise based on knowledge of the capability of each different technology at the desired range, and the resulting data must be filtered and edited. Most of the systems focus only on the acquisition of the 3D geometry, providing only a monochrome intensity value for each range value. Some systems directly acquire color information for each pixel while others have a color camera attached to the instrument, in a known configuration, so that the acquired texture is always registered with the geometry. However, this approach may not provide the best results since the ideal conditions for taking the images may not coincide with those for scanning. The accuracy at a given range varies significantly from one scanner to another. Also, due to object size, shape and occlusions, it is usually necessary to perform multiple scans from different locations to cover every part of the object: the alignment and integration of the different scans can affect the final accuracy of the 3D model. Furthermore, long-range sensors often have problems with edges, resulting in blunders or smoothing effects. [8]

(4) Combination of image- and range-based modeling.

In many applications, a single modeling method that satisfies all the project requirements is still not available. Photogrammetry and laser scanning have been combined in particular for complex or large architectural objects, where no technique by itself can efficiently and quickly provide a complete and detailed model. [8]

1.5 Research Significance

Three-dimensional visualization can be a useful tool in guiding students and visitors to reach places inside the university. When used effectively, the 3D model is a tool that will save time and yields a heightened awareness of college and administration buildings.

In general, the benefits associated with 3D visualization include the following:

- Helps the new students to maximize the effective time of doing registration procedures by finding offices rather than spending time in asking.
- Illustrating features of buildings (e. g. offices, libraries, labs, lecture halls and cafeterias).
- Providing visual support of university management when they need to make some improvements by adding or modernizing buildings.

- Understanding and visualizing inaccessible locations (lecture halls, offices etc.) buildings outside student collage.

1.6 Thesis Layout

This thesis contains of seven chapters showing the aimed objectives and the implementation. The first chapter is an introduction; the second one is about the related work and literature review, chapter three contains the methodology and planning, chapter four illustrates system analysis and design, chapter five is the real simulation and results, chapter six is conclusion and outlook, the last one illustrates the list of references.

Chapter 2

Related Work and Literature Review

- 2.1 Theoretical Framework.
- 2.2 Literature Review.
- 2.3 Proposed system description.

2.1 Theoretical Framework

In the following we use methods of computer graphics, Geographic Information Systems and photogrammetry to solve the problem of constructing Virtual Reality 3D models and to convert them into GIS objects allowing for spatial analyses, such as short path analysis, buffering etc. Therefore, the strength of these three fields is presented first.

2.1.1 Computer Graphics

Computer Graphics is the discipline of producing pictures, images, drawings and maps using a computer including modeling - creation, manipulation, and storage of geometric objects and rendering – converting a scene to an image, or the process of transformations, rasterization, shading, illumination, and animation of the images [4]. As demonstrated by Fig. 2 very lively 3D virtual reality models can be created.

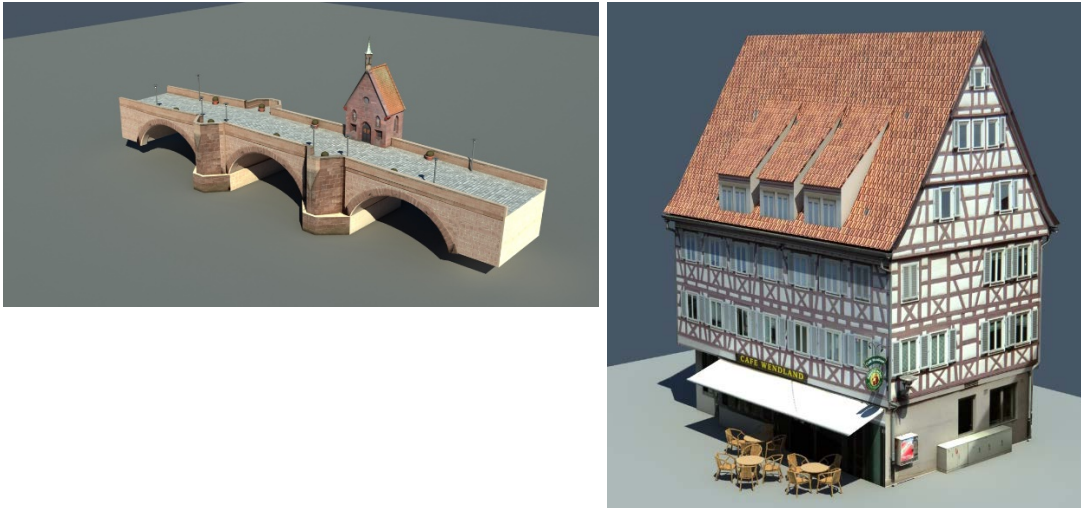

Fig. 2.1 (a) 3D Reconstruction of a bridge (b) 3D Reconstruction of a building

2.1.2 Geographic Information Systems (GIS)

a. GIS Definition

GIS is a computer based system that provides the following four sets of capabilities to handle georeferences and data:

1. Data capture and preparation.
2. Data management, including storage and maintenance.
3. Data manipulation and analysis.
4. Data presentation. [6]

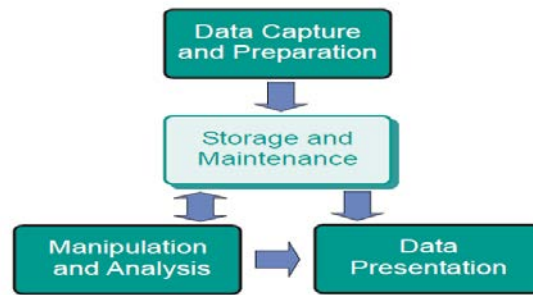

Fig. 2.2. Functional component of GIS.

GIS is spatial representation and analysis of information (attribute data) that is positioned to correspond to the same X, Y coordinates throughout the various map layers. [5]

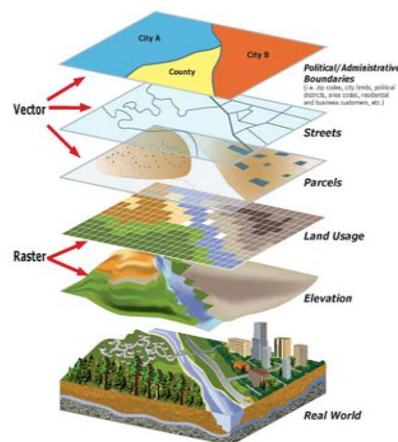

Fig. 2.3. An example of map layers used altogether in GIS.

One of the main usage of GIS is to help making decisions. The fact that we can only represent parts of the real world teach us to be humble about the expectations that we can have about the system - all informations it can possibly generate for us in the future will be based upon the data which we provided to the system in the past and present. [6]

b. Models and Modeling

‘Modeling’ has many different meanings. A representation of some parts of the real world can be considered a model because the representation will have a certain characteristic in common with the real world. It also allows us to study and operate on the model itself instead of the real world in order to test what happens under varies conditions, and helps to answer ‘what if’ questions.

The term model is quite often used as representation in a GIS environment. The most familiar model is a map. A map is a miniature representation of some part of the real world. Databases are another important class of models as they can store considerable varieties of data and also provide various information to operate on the stored data. [6]

2.1.3 Photogrammetry

Photogrammetry is the science of obtaining reliable information about the prosperities of surfaces and objects without physical contact with the objects, and of measuring and interpreting this information.

In order to simplify understanding the abstract definition above and to get a quick grasp of the complex field of photogrammetry, a system approach has been adopted as illustrated in Fig. 2.4. [9]. It should be mentioned here, that modern photogrammetry is providing high resolution point clouds, derived by dense image matching methods, which have the same quality and higher resolutions than those of laser scanning. The photos are located by photogrammetric Bundle Block adjustments and/or Structure-from-Motion algorithms of Computer Vision, before the pixel-wise matching is performed.

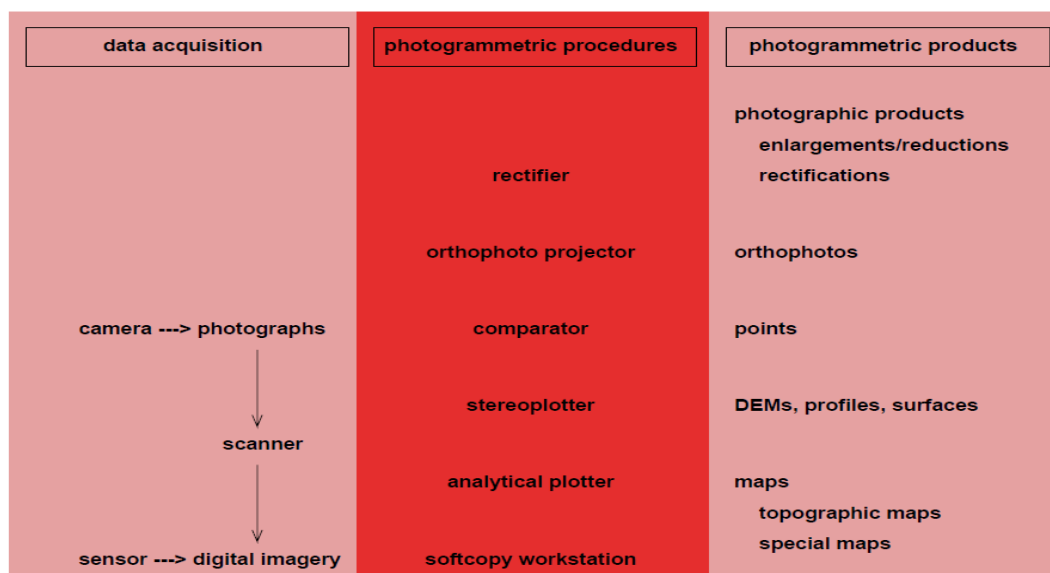

Fig. 2.4. Photogrammetry portrayed as a systems approach. The input is usually referred to as data acquisition, the “black box” involves photogrammetric procedures and instruments, the output comprises photogrammetric products.

Photogrammetric Camera

In the beginning we introduced the term sensing device as a generic name for sensing and recording radiometric energy. Fig. 2.5 shows a classification of the different types of sensing devices.

An example of an active sensing device is radar. An operational system sometimes used for photogrammetric applications is the side looking airborne radar (SAR). Its main advantage is the fact that radar waves penetrate cloud and haze.

Passive systems fall into two categories: image forming systems and spectral data systems. We are mainly interested in image forming systems which are further subdivided into formatting systems and scanning systems. Image forming systems acquire all data at one instant in time. Scanning systems obtain the same information sequentially for example by collecting scanline by scanline. Image forming systems record radiant energy at different portion of the spectrum. The spatial position of the recorded radiation refers to a specific location on the ground. The image process establishes a geometric and radiometric relationship between spatial positions of the object and image space.

Amongst all of the sensing devices used to record data for photogrammetric applications, the photographic systems with metric properties are the most frequently employed. They are grouped into aerial cameras and terrestrial cameras. Aerial cameras are also called cartographic cameras. Panoramic cameras are examples of non-metric aerial cameras. Fig. 2.6 depicts an old aerial film-based camera.[6]. It should be mentioned here, that nowadays all aerial photos are collected using digital camera systems, based on CCD and CMOS technologies.

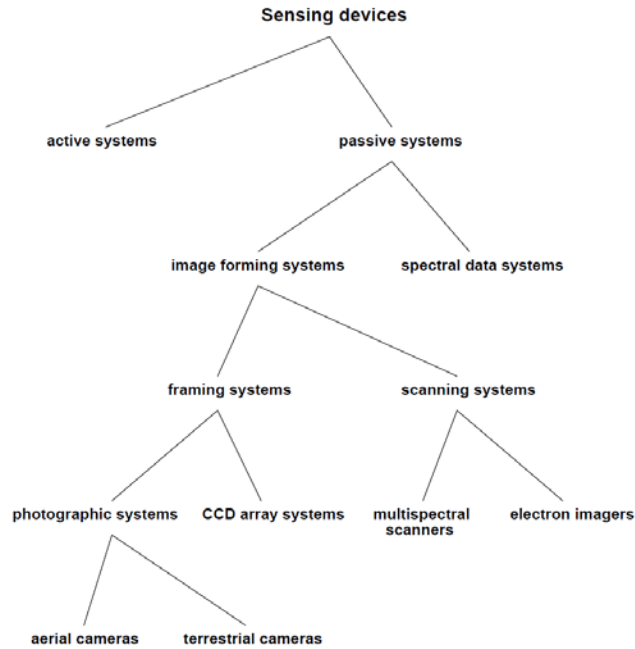

Fig. 2.5. Classification of sensing devices.



Fig.2.6 (a) aerial cameras Aviophoto RC20 from Leica.



(b) Angular coverage, photo scale and ground coverage of camera.

2.1.4 RGB-D Mapping

RGB-D Mapping, a full 3D mapping system that utilizes a novel joint optimization algorithm combining visual features and shape-based alignment. Visual and depth information are also combined for view-based loop closure detection, followed by pose optimization to achieve globally consistent maps. [7]

Introduction

Establishing rich 3D maps of environments is an important task for mobile robotics, with applications in navigation, manipulation, semantic mapping, and telepresence.

Most 3D mapping systems contain three main components:

- The spatial alignment of consecutive data frames.
- The detection of loop closures.
- The globally consistent alignment of the complete data sequence.

While 3D point clouds are extremely well suited for frame-to-frame alignment and for dense 3D reconstruction, they ignore valuable information contained in images [7].



Fig. 2.7 (left) RGB image and (right) depth information captured by an RGB-D camera. [7]

RGB-D cameras are sensing systems that capture RGB images along with per pixel depth information.

RGB-D cameras allow for the collection of reasonably accurate mid-resolution depth and appearance information at high data rates. [7]

Techniques for 3D Mapping

3D Mapping is used for:

1. Robots operate in the three-dimensional world
2. Three-dimensional maps, which support
 - Object recognition.
 - More accurate path planning
 - More reliable localization and data association.
 - Navigation on uneven terrain.[4]

The 3D Mapping Process:

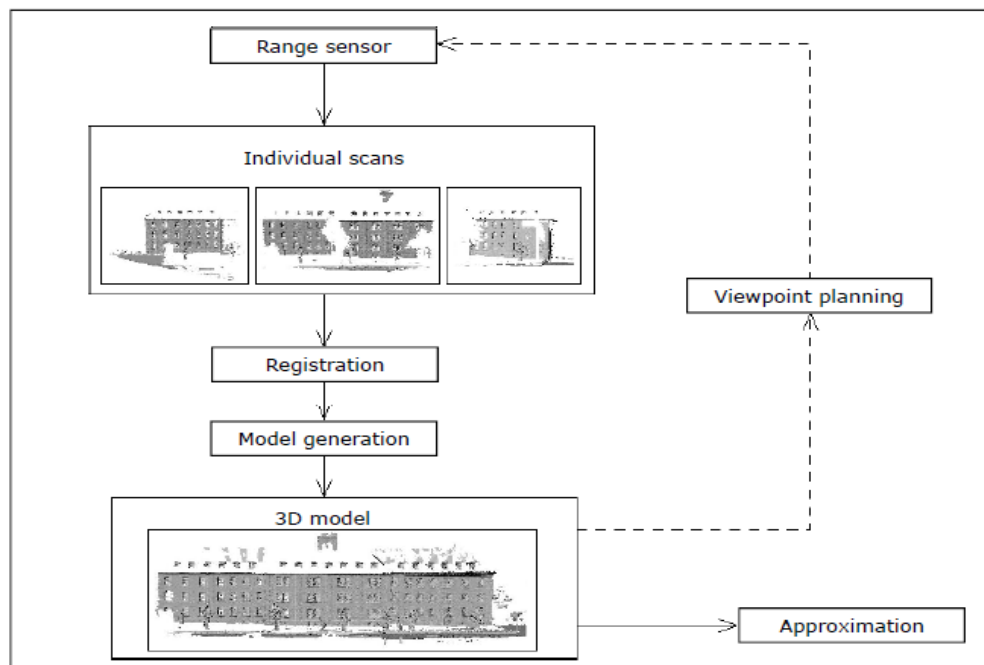

Fig. 2.8. The 3D Mapping Process [4]

3D computer graphics

3D computer graphics (in contrast to 2D computer graphics) are graphics that use a three-dimensional representation of geometric data (often Cartesian) that is stored in the computer for the purposes of performing calculations and rendering 2D images. Such images may be stored for viewing later or displayed in real-time. [4]

Almost all 3D models can be divided into two categories.

- **Solid** - These models define the volume of the object they represent (like a rock). These are more realistic, but more difficult to build. Solid models are mostly used for non-visual simulations such as medical and engineering simulations, for CAD and specialized visual applications such as ray tracing and constructive solid geometry.
- **Shell/boundary** - these models represent the surface, e.g. the boundary of the object, not its volume (like an infinitesimally thin eggshell). These are easier to work with than solid models. Almost all visual models used in games and film are shell models.

3D modeling software

3D modeling software is a class of 3D computer graphics software used to produce 3D models. Individual programs of this class are called modeling applications or modelers.

3D models represent a 3D object using a collection of points in 3D space, connected by various geometric entities such as triangles, lines, curved surfaces, etc. Being a collection of data (points and other information), 3D models can be created by hand, algorithmically (procedural modeling), or by scanning.

Modeling process

1. **Polygonal modeling** - Points in 3D space, called vertices, are connected by line segments to form a polygonal mesh. The vast majority of 3D models today are built as textured polygonal models, because they are flexible and because computers can render them so quickly. However, polygons are planar and can only approximate curved surfaces using many polygons.
2. **Curve modeling** - Surfaces are defined by curves, which are influenced by weighted control points. The curve follows (but does not necessarily interpolate) the points. Increasing the weight for a point will pull the curve closer to that point. Curve types include non-uniform rational B-spline (NURBS), splines, patches and geometric primitives
3. **Digital sculpting** - There are currently 3 types of digital sculpting: *Displacement*, which is the most widely used among applications at this moment, *volumetric* and *dynamic tessellation*.

2.2 Literature Review

Extensive research and developments have been carried out in the last years. Here a brief excerpt is cited in more details.

2.2.1 Review of prior studies:

1. Case 1 :

- **Title of Study:** Texture Mapping and Implementation Aspects for 3D GIS Applications
- **Name of researcher:** Nedal Al-Hanbali
- **Study objectives:** 3D modeling of Al Hussein Public Parks

The main objective of 3d modeling and texture mapping is to build a suitable procedure for documentation of cultural heritage objects and thus to serve as a tool to make information accessible for documentary purposes and research tourism.

It is also an application for any interested person, who can investigate the object without going to the site. The result of the documentation has to include not only the graphical knowledge but also some non-graphical information such as the objects' history, conservation status and owners [2].

(a) Methodology and Project Planning

In the following are the implementation steps applied to build a true reality 3D GIS model with texture mapping that is implemented for King Hussein Park [2].

1. Data Modeling.
2. Data Measurements, Processing and Preparation
3. Build 3D model.
4. Build a 3D GIS model with all relational spatial data base.
5. Texture Mapping.

(b) Scope of study

The scope of study includes Al Hussein Public Park, which is one of the landmarks in Amman, Jordan. The Park includes a cultural village, sports fields, memorial building, historical passageway, decorated gardens, amphitheater, circular yard, automobile museum, children museum, traffic park, and walls and gates. The study aims at showcasing the cultural heritage once it has been reformulated and then presented in a contemporary way. It contains sites that embody the goal of preserving the architectural heritage and emphasize esthetics [2].

(c) **Results**

- One result of the research is the exploration to effectively use a 3D GIS
- Modeling in various applications.
- Virtual city modeling to build three dimensional GIS models, that allow for 3D spatial analysis for various applications. The approach used in this work presents a simple strategy that is suitable for required spatial applications.
- Provide more realistic views and virtual reality environments. Moreover, two procedures to add texture mapping to the 3D objects are discussed and compared. [2]

(d) **Conclusions and Future work**

It is important to define an automatic procedure for fitting available vector data such as streets to DTM and orthophoto to build virtual 3D GIS models. More work and investigation are being made for 3D virtual city models for cadastral applications, such as adding details for Building Texture and Building Floors using CAD drawing details

- Adding attributes to these floors.
- Adding streets features based on texture captured from orthophotos.
- Populating these models on the internet through web-mapping applications [2].

(e) **Society and sample of study**

A sample has been taken by selecting a sample of tourists and visitors of Al Hussein Public Park in order to study the possibility of applying the study [2].

2. Case 2:

- **Title of Study:** Workflows and the role of images for virtual 3D reconstruction of no longer existant historical objects.
- **Name of researcher:** S. Münster, Media Centre, Dresden University of Technology, D-1062 Dresden, Germany.
- **Study objectives:** 3D reconstruction of historic objects.

Generally, research about the usage of images is nothing new and takes place in relation to their usage in various contexts, such as engineering, design, architecture or for scientific and research context [7].

(a) Methodology and Project Planning

The author performed three stages of analysis using widely established methods from social sciences: the first stage was a qualitative content analysis for publications to examine current usage scenarios. The investigation included a sample of 452 journal articles and conference proceedings dealing with 3D reconstruction of historic items. A second stage performs a qualitative content analysis with a sample of another 26 international publications dealing with a reconstruction of no longer existent objects, and a third stage includes four case studies exploring 3D reconstruction projects of historic buildings over time to examine aspects of visual communication and their evolution during a project creation process.[7]

(b) Implementation of Study

At a glance, images are widely used for the reconstruction of existent objects. Especially reconstructions of no more existent or never realized objects are mostly practiced by interdisciplinary teams including modelers and researchers. For these projects images are the most important sources. That results in comparison to textual sources not only from their richness and clearness of included information about visible aspects like objects, situations, geometries or sometimes surfaces, but also from their easy visual transferability and comparability with visual 3D models. [7]

(c) Results

This study performs a qualitative, explorative research using methods from social sciences. That indicates a possibly subjective decision taking. Moreover, the sample is, in relation to similar investigations, relatively small and based mostly on ex post material and should be further increased. Fig.2.9 demonstrates the workflow until the final visualization. [7]

(d) Conclusions and Future work

Insights for performing 3D reconstruction of historic objects could be that many suggestions from project and innovation management would fit for that kind of task and could foster working processes. While there are many efforts to make sources used for reconstruction visible in results, too, there are only a few possibilities and practically used approaches to making the decision and creation processes transparent. In addition, it would be important to find strategies to include a creation process in scientific discourse. [7]

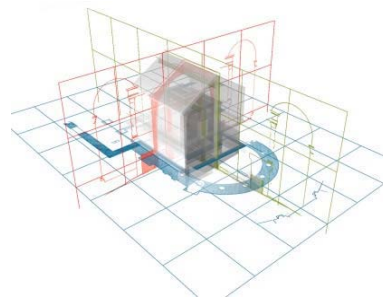

Sources

Historical sources

- Hist. images: panoramas, plans
- Additional hist. sources: i.e. text

Contemporary sources

- Visual: sites, plans, photography
- Data: laser scans, photogrammetry

Logical "sources"

- Architectural systems
- Analogies
- Inner model logic

Modeling

Semi-automated modeling:

- algorithmic reconstruction

Procedural generators

Manual CAD/VR modeling

Visualization

Static images

Animations

Interactive Visualization: i.e.

games

Data Output: i.e. for manufacturing

Fig. 2.9. Classification schema: Sources, Modeling, Visualization.

(e) Society and sample of study

A sample has been taken by doing 9 interviews with key role team members; in addition, 6 direct and participating observations of team meetings were carried out. Also a significant number of documents, including log files, communication data, protocols, sources and model renderings were included in investigation.[7]

3. Case 3:

- **Title of Study:** GIS Applications for Building 3D Campus, Utilities and Implementation Mapping Aspects for University Planning Purposes.
- **Name of researcher:** A. Al-Rawabdeh, N. Al-Ansari, H. Attyal and S. Knutsson.
- **Study objectives:** real 3D GIS model for the campus of the Al al-Bayt University.

The following study built 3D GIS map and all utility information for Al al-Bayt University campus as an example. The primary objective is to improve data management (e.g. Maps, plans, usage of facilities and services) and to develop methods using 3D spatial analysis for specific applications at the university. [3]

(f) Methodology and Project Planning

The following steps are implemented to build a real world visualization of Al_Bayat University: data acquisition, generation of a 3D model, visualization of the 3D model. Detailed information on these works is presented in the following.

- Existing GIS layers: Layers are groups of features organized into an object called a Shape file. In this study, different vector layers were available from the Department of Maintenance and Engineering inside the campus. These layers are: buildings layer, road networks layer and utility layers.
- AutoCAD files (CAD format data) made available from the scanned maps of the area and construction drawings. Raster imagery such as Google earth image for the area of interest;
- Attribute database and documentations related to the park's information.

(g) Scope of study

Al-Bayt University is one of the public universities in Jordan. It was established as one of the landmarks within the Al-Mafraq municipality. It contains parks, sports fields, gardens space, museum, faculty, buildings, mosque and gates.

(h) Results

3D GIS provide urban designers and planners with a useful tool for modeling and analysis. The 3D GIS application was developed in order to evaluate urban space efficiently and to provide information about urban planning to local communities. The application enables users to visualize complicated urban planning information in the 3D way, to evaluate the allowable capacity of the block and to simulate building plans, as illustrated in Fig (2.10). [3]

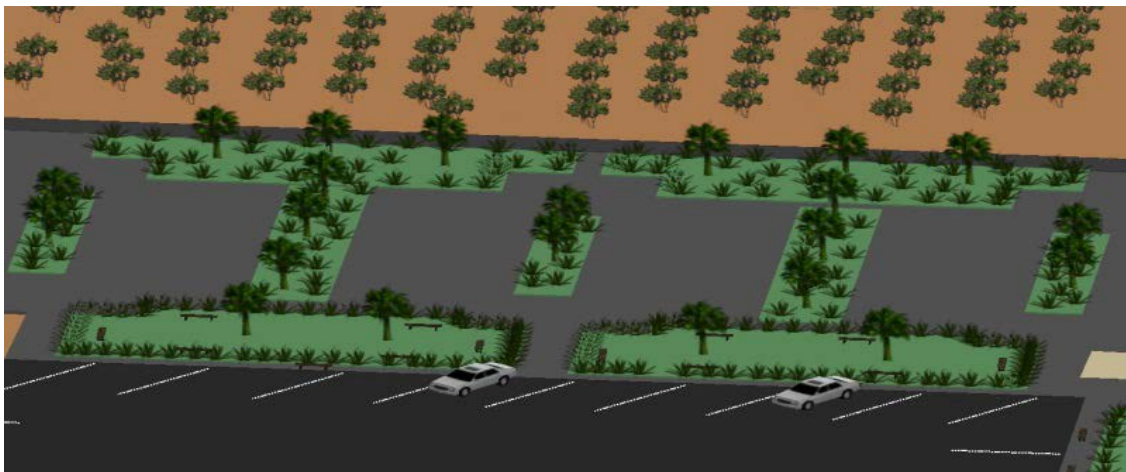

(A): Green space 3D models with color texture using 2D vector layer in the ArcScene environment.

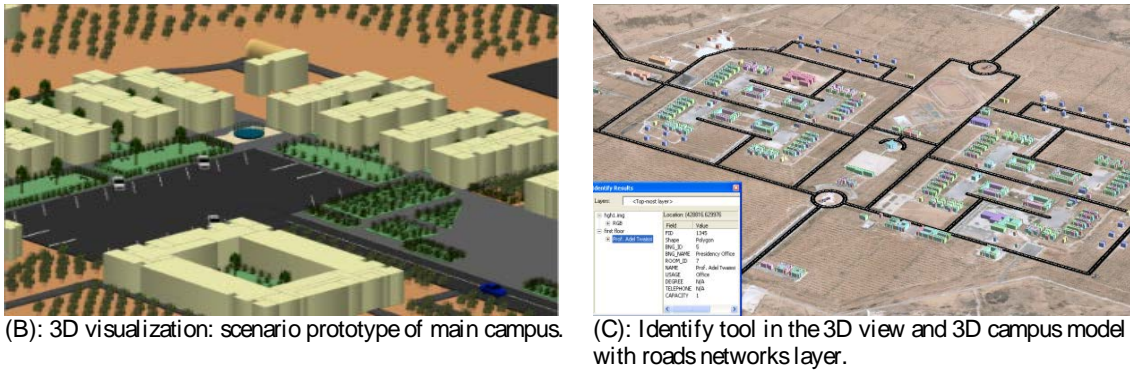

Fig 2.10. (A),(B),(C) Prototype models of 3D visualization.

2.2.2 Own comments on previous studies

The previous studies contributed to an examination to use current off-the-shelf software technology to build geometry and texture for 3D GIS models using several techniques for various applications.

This research aims to take advantage of the proposed recommendations, including the possibility of applying the regulations on the 3D mapping systems using photogrammetry and viewing real world models over PC's desktop and smartphone's environment.

2.3 System description

2.3.1 Current System

Sudan University of Science and Technology, Khartoum with its main campus is the headquarter of the University and consists of a number of offices: the presidential offices, colleges, and offices of particular interests such as the students' deanship and the secretariat of academic affairs. The current system relies on labeling and signs with names of faculties and departments and the names of the halls and offices of every building. For new students during registration time the university offers some brochures and banners greeting for each College and some information about the departments, halls and labs with pictures.

Placed signs indicate the registration steps and offices for each college. For visitors there is a person appointed to help them as a guide.

2.3.2 Current System Problems

1. The students have not any idea about the University before registration, unless visiting the College.
2. Labels or Signs of buildings are not obvious small.
3. Some privacy places for males/females are not cleared as well as prayers places.
4. Visitors or new students have to ask every time when they want to reach a particular place within the University.
5. Delaying and loosing time and efforts asking about locations.

2.3.3 Proposed solutions

1. Distribute brochures about each university faculty from the beginning to university admissions.
2. Design maps showing the main features of the buildings, colleges and access.
3. Definition of whole-length of colleges and University buildings with photos on the website of the university.
4. Using GPS technology to identify sites via satellite navigation.

2.3.4 Proposed System Description

The main objective of 3d modeling and texture mapping is to build suitable procedures for SUSTECH buildings and thus to serve as tools to make information accessible for students and visitors, who can investigate the campus without going to the site.

The importance of campus planning focuses on offering 3D real world visualization for SUSTECH main campus buildings with its semantic information. In addition the proposed system will be accessible from desktops and smartphones to take advantage of the virtual visualization anytime.

2.3.5 Scope of system

The proposed system offers a 3D model for the main campus of SUSTECH and includes the following buildings: University Administration, Students' Deanship, the Secretariat of Academic Affairs, Scientific Research Council, College of Graduate studies, College of Fine and Applied Art, College of Science, College of Computer Science and Information Technology, College of Technology, College of Languages, Institute of Islamic Research

and Science, Personnel Office, Financial Administration, Legal Affairs Office, and Administration Affairs.

In addition, the gates and milestones for every colleges are on display, also mosques and restrooms for female students. The system offers 3D visualization for buildings as well and provides information using desktop and tablet computers and smartphones.

2.3.6 Proposed System Problems

The proposed system may face hardware and software problems as mentioned below:

1. Suggested software properly not found or it may be coasted.
2. Obtaining a high precision model is time and effort consuming because of lack of hardware scanning devices.
3. High technical requirements such as storage, processors and high precision resolution.

Chapter 3

Methodology and Research Planning

- 3.1 Research Community.
- 3.2 Methodology and Research Planning.
- 3.3 Selected Methodology and Techniques

Overview

This chapter contains three main headlines, the first about the community of research; the second is Methodology and Research Planning, and the third one is selected methodology and techniques.

3.1 Research community

A university campus is a complex infrastructure. Especially to new students and visitors because they have a hard time to orientate themselves and finding places. The main campus of SUSTECH has different buildings with up to two floors high - most of these buildings are far from each other. Even if there are maps at some points on campus, users do not have continuous help to get to their destination. They can try to figure out a way to get to their target on these static maps, but as soon as they start walking in the target direction they are without help anymore. So, how is it possible to help freshmen and inexperienced people to orientate them on the university campus and how can they be supported using modern tools.

The Main Campus of SUSTECH includes the University Administration, Students' Deanship, the Secretariat Academic Affairs, Scientific Research Council, College of Graduate Studies, College of Fine and Applied Art, College of Science, College of Computer Science and Information Technology, College of Technology, College of Languages, Institute of Islamic Research and Science, Documentation and Information Center, Personnel Office, Financial Administration, Legal Affairs Office, Administration Affairs.

3.2 Methodology and Research Planning

The main campus was selected to be generated as a 3D GIS model, which would include not only the campus buildings but also administration buildings, lectures halls, restrooms, cafeterias, libraries, laboratories, mosques and gates.

In this study, 3D modeling of the SUSTECH campus and its application for a campus information system consists of the following steps: data acquisition, generation of a 3D model, visualization of the 3D model. In the following the implementation steps required to build a true reality 3D GIS model of SUSTECH with texture mapping are given.

1. Data Modeling:

- ❖ **Data collection** of all available geospatial databases and attribute data no matter it is
 - Images captured by scanning buildings for dense image matching.
 - Point cloud files (Las data format).
 - Files available from point clouds for the 3D model construction.
 - Attribute database and documentations related to the SUSTECH information.
- ❖ **GIS Data Modeling:** This is an important step to define all required geospatial databases including vector and raster classes and their relationship classes based on the defined objectives of the project.

This will draft what is required and also missing to build the desired GIS data model.

2. **Data Measurements, Processing and Preparation:** To build the required 3D GIS information system.
 - ❖ **Data measurements and capturing:** In this process the following are some important data measurements:
 - Dense images of the area of interest using a high precision camera.
 - Stereo images of objects to build 3D models,
 - Photos of required texture to be used as filters later on to build texture to 3D models.
 - ❖ **Data Processing and Preparations:** In this process the following are some important processing steps:
 - Build point clouds for the area of interest (AgiSoft PhotoScan is used).
 - Build 3D view of the point clouds (Autodesk 3DMAX and Trimble SketchUp are used).
 - Edit captured photos and add texture (MS Paint is used).
 - According to the GIS data-model, build 2D layers and also add their attribute data (Esri ArcMap is used).
 - Build relational databases within the GIS data model layers (Esri ArcMap and Esri ArcEditor are used).
3. **Build 3D model:** Based on required details and available spatial data and also according to the GIS data model design all the needed features are selected. In the following are the important implemented cases:[2]
 - Case I Simple 3D shape geometry:** In this case the 2D layer was built and the height dimension was determined either by direct survey measurements or taken from CAD drawings. The 3D model can be built directly in the 3D GIS software environment. The shape appears like 3D block shapes (Esri ArcScene software is used).
 - Case II 3D CAD Model is available:** In this case, the dimensions have to be verified by scaling it with the built 2D layer and also via survey measurements. The final 3D model is then verified and georeferenced to its exact position on a map (Autodesk AutoCAD and Trimble SketchUp software's are used).
 - Case III Only 2D layer is available:** In this case close range photogrammetry is used to build a 3D wire mesh of the required object(s) using the captured stereo imagery during the data capturing step (AgiSoft PhotoScan and Photomodeler software's are used).
 - Case IV some parts are available in 2D and others in 3D:** Combination of case II and III is used, but it is very important to use a consistent reference system to merge all 3D objects into one object (Trimble SketchUp software works well in this case).
4. **Build a 3D GIS model with all relational spatial data base** that corresponds to the 3D model. There are several techniques to insert the built-up 3D models from step 3 within the 3D GIS environment as follows:[2]

- ❖ **The 3D GIS environment** in our case is the ArcScene environment of the ArcGIS software. The datum for providing a reference base-height for any inserted point, 2D or 3D objects is chosen.
 - **Case I Simple 3D shape geometry:** In this case ArcScene build the 3D model directly using the 2D vector layer with the added height information as part of the layer attribute for each feature in the layer, or added directly as a constant height for all features in the layer. A DTM is also specified as the base-height for all layers.
 - **Case II 3D CAD Model is available:** In this case, if the CAD software has the capability to export the 3D model file into 3D shape file, it then can be inserted directly into the ArcScene environment. Quite often the file can be imported into SketchUp software, where it will be exported into the proper format for ArcScene. It is important to note that complex 3D models should be split as much as possible to smaller objects in order to be able to export it easily into the environment using the geodatabase format. Our practice found that the best scenario is to use SketchUp software. You can better control your splitted objects since the export formats are geodatabase standards. Also, it is important to georeference the model to its exact position in ArcScene before exporting it.
 - **Case III Only 2D layer is available:** In this case close range photogrammetry such as Photomodeler or other photogrammetry software such as SOCET SET or Z/I can export the 3D model to 3D CAD model or shape file. Our recommendation is to convert the models to CAD format and then exporting them to SketchUp software and repeat the same as described above.
 - **Case IV some parts are available in 2D and others in 3D:**
A Combination of case II and III is used, but it is very important to use a consistent reference system to merge all 3D into one object (SketchUp software works well in this case).
5. **Texture Mapping:** Appending to all facets of the 3D features the true texture is very essential to simulate reality and thus provide the user/planner with a true scene that can help in making better decisions. The following are the options and scenarios one can follow:[7]
- ❖ **Use the Orthophoto with added DTM** as a base-height to provide true texture of the earth and ground surface for the area of interest.
 - ❖ **Append/stitch texture to build up 3D** models using the following options:
 - **Orthophoto Accurate Texture Mapping:** One needs to build Orthophotos of all the faces of the objects. Use these images as filters to append/stitch these to the 3D CAD model surfaces using Sketch up or 3D MAX software's.
 - **Direct photo Texture Mapping:** It is important when capturing the photos for the model surfaces to make the line of site of the camera axis as perpendicular as possible to the surface of interest. Then use these photos as filters to append/stitch these to the 3D CAD model surfaces using SketchUp or 3D MAX software.
 - In both cases, the best way to export the 3D model with texture is through exporting all models to SketchUp software and then exporting it in a geodatabase format to ArcScene software.

❖ **Export the built up 3D model object with texture as point-symbols.**

SketchUp software is designed to work perfectly in case of:

- The object is designed to provide general attributes of the whole building for example, if the object is very complex and cannot be exported as true 3D model with texture.
- The objects are standard and are very similar in shape such as villa compounds, To be built using other softwares such as SketchUp or 3D Max.[2]

The resultant 3D reality model offers a flexible and interactive visual decision support system for data management. The following sections are the direct implementation results of the above discussed methodology for various applications, that are related to the conducted system.

3.3 Selected methodology and techniques

The suggested methodology is very flexible and can be utilized and implemented for various types of projects and applications, that are becoming essential in the near future. Photogrammetry and Texture mapping is now becoming feasible with low cost and less time consuming using the new capabilities of the below mentioned software's.

In this proposed system, several softwares will be employed and used in order to complete the required production, which are the following:

a. AgiSoft's PhotoScan:

- AgiSoft PhotoScan is an advanced image-based 3D modeling solution aimed at creating professional quality 3D content from still images.[1]
- It will be used to extract the point clouds by dense image matching of the areas of interest.

b. Trimble's SketchUp Pro(version 2016):

- The platform enables users to create collections of models, including 3D buildings, and share them with fellow modelers around the world. SketchUp, which was a tiny startup when it was bought by Google in 2006, now boasts of millions of active users.[12]
- It will be used to import point clouds in *.las format and exporting 3D models from and to ArcGIS depending to build/complete 3D building models. Finally it is used for adding the true texture to these models.
- The Undet extension package works well with sketchUp for importing point clouds and exporting 3D models in various file's formats.

c. Esri's ArcGIS 10.1:

- ArcGIS Desktop is comprised of a set of integrated applications, which are accessible from the Start menu of your computer: ArcMap, Arcscene and ArcCatalog.

ArcMap is the main mapping application which allows you to create maps, query attributes, analyze spatial relationships, and layout final projects.

ArcCatalog organizes spatial data contained on your computer and various other locations and allows for searching, previewing, and adding data to ArcMap as well as manage metadata and set up address locator services (geocoding).

ArcToolbox is the third application of ArcGIS Desktop. Although it is not accessible from the Start menu, it is easily accessed and used within ArcMap and ArcCatalog. ArcToolbox contains tools for geoprocessing, data conversion, coordinate systems, projections, and more. [10]

- ArcMap will be used to build 2D GIS layers and data-model, in addition to ArcScene that provides suitable 3D environment

d. Sketchfab:

- Is the leading Internet platform to publish and find 3D and VR content, anywhere online. Moreover, it is a good environment to upload files in almost any 3D format.[11]
- Sketchfab will be used to visualize the 3D model in VR mode by uploading the model to be accessible online.

Chapter 4

System Analysis and Design

4.1 System Requirements

4.2 Database Analysis and Design

Overview

This chapter contains system requirements, subdivided in functional and non-functional requirements and system analysis with design.

4.1 System Requirements

4.1.1 Functional Requirements:

1. The system provides 3D design for SUSTECH Main Campus.
2. The system aims to provide information about all the campus buildings.
3. Also its aims to represent all resources within the campus in a hologram.
4. The system offers real world visualization, helps students and visitors viewing the resources inside the campus and administration buildings.
5. It also supports virtual visualization over smartphone platforms to be accessible anytime.
6. The system illustrates locations of the libraries, laboratories and lecture halls.
7. It also illustrates locations of landmarks, gates and textured buildings.
8. It even identifies locations of mosques and other places of prayer in the university by defining restrooms and private sections for male and female students.
9. It illustrates locations of cafeterias and stationery shops.
10. It marks each faculty with its statues and logos.
11. At this point in time trees are not yet involved in the model.

4.1.2 Technical Requirements:

The building geometry (dense point cloud and mesh generation) usually has the largest memory footprint, especially if the model is constructed in medium or high quality, This fact should be carefully taken into account.

The processing of the photographs and the 3D model construction comprises the following main system requirements:

Minimal configuration

- ❖ Windows XP or later (32 or 64 bit), Mac OS X Snow Leopard or later, Debian/Ubuntu (64 bit).
- ❖ Intel Core 2 Duo processor or equivalent.
- ❖ 2GB of RAM

Recommended configuration

- ❖ Windows XP or later (64 bit), Mac OS X Snow Leopard or later, Debian/Ubuntu (64 bit).
- ❖ Intel Core i7 processor.
- ❖ 12GB of RAM.

The number of photos, that can be processed by PhotoScan depends on the available RAM and reconstruction parameters used. Assuming that a single photo resolution is of the order of 10 MPixel, 2GB RAM is sufficient to create a model based on 20 to 30 photos. 12GB RAM will allow to process up to 200-300 photographs.

In addition capturing photos for objects must be taken panoramically and it is better to use a high precision camera as well as an Xcopter with a camera on board.

The resulting 3D model must be available over desktops and various smartphone platforms (Windows, Android, and iOS)

4.1.3 Nonfunctional Requirements

In order to obtain better model visualizations, the system has to achieve the following specified requirements:

1. Performance: The most important requirement is the performance of the system which includes the following :
 - Query and Reporting time: the response time between the mouse action and retrieving object information.
 - Response time: also the time of loading the model, which is subject to the screen refresh times or orientations.
2. Availability: the system needs to be available all the time, for every student/visitor over desktop and smartphone platforms.
3. Maintainability: the model also has to be updated due to the ongoing renewal of campus buildings.

4.2 Analysis and Design

4.2.1 Database Requirements

1. SUSTECH's main campus consists of a number of colleges and administrative buildings: the Faculty of Computer Science, the College of Applied Arts, the Faculty of Science, and the Faculty of Graduate Studies. Furthermore, it includes facilities for personnel matters, scientific affairs, building security and safety.
2. Each college has its own buildings: lecture halls, laboratories, libraries, offices of professors and college registration offices.
3. Near the college there are stalls and photocopying facilities.
4. Also the university campus contains some other resources such as: cafeterias, restrooms for males/females and the Grand Mosque.
5. **Lecture halls:**
 - Professor IZZ_ALDEEN halls, that is seven halls specialized for the Faculty of Computer Science.

- Professor HASHIM OBID halls, seven halls specialized for the Faculty of Science.
 - The College of Science and Technology has special halls known “CR” halls.
 - The College of Administrative Sciences also has special halls known as “IR” halls.
6. **Laboratories:**
- The Faculty of Computer Science and Information technology CSIT has 10 Laboratories.
 - The Faculty of Applied Arts offers Laboratories known as : Sculpture lab - Colouring lab - Interior Laboratory - Porcelain Factory - Calligraphy lab - Demonstration design lab - Photography lab
 - The Faculty of Science offers the following labs: Physics laboratories - Microbiology labs and Chemistry labs.
7. **Libraries:**
CSIT Library, College of Sciences Library, Library Faculty of Applied Arts and Islamic Studies Library
8. **Registration offices:**
Office of the Faculty of Computer Science, Faculty of Applied Arts offices, the Office of the Faculty of Graduate Studies, Faculty of Science, offices
9. **Professors offices:**
CSIT college offices according to its department: Department of Information Systems, Department of Software Engineering, Department of Networks and the Department of Computer Science.

4.2.2 Database Design

As well known, GIS layers are groups of features organized object-wise and are stored in a Shapefile format. In this Research, 2D and 3D layers have been created using Esri’s ArcGIS software.

The model comprises 2D GIS layers, which contain the geospatial data of the objects. In particular these layers are the building layer and the college layer. Fig. 4.1 shows the GIS layer structure and hierarchy.

1. Database Transactions

- Information retrieval is essentially required, when the users inquire about a particular object by getting a popup message. Thus the data must be well organized.
- The 3D model of the university will be visible for each student and visitor online for better view and access over desktops (WebGL browser) and smartphones allowing them to orient the model or retrieve geodata in response of a mouse click.

2. Geodatabase schemas

The 3D-map database employed in this study is a database involving the characteristics shown in Fig 4.1. The geospatial data in the contemporary GIS are organized in one of many geo-databases also called GIS or spatial databases. Commonly, a geo-database is an object-relational database designed to store, query, and manipulate quantitative data, such as geometry and coordinate data types, as well as qualitative data called attribute data types [8]. The geometry and coordinate data types represent the shape and the location of an object in the physical world. All geospatial data are organized in relational tables (Fig.4.1).

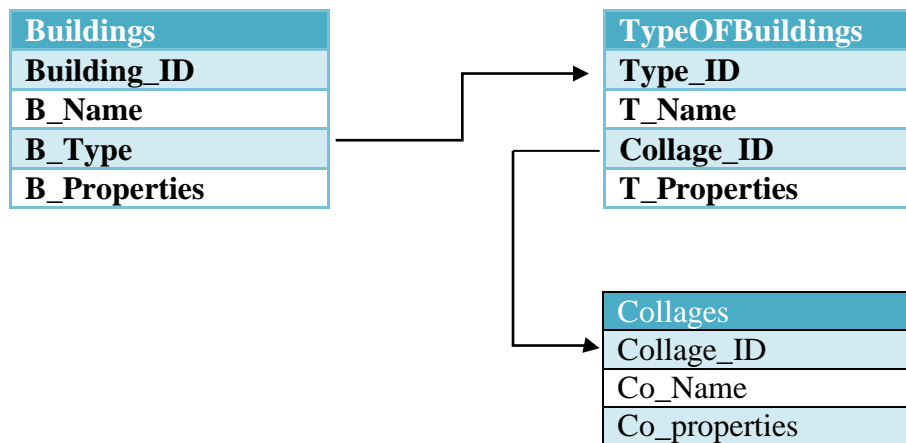

Fig. 4.1: SUSTECH Campus Geodatabase Schema.

3. Geospatial data structure and methodology

The key thematic data layers of such a GIS described above comprise campus, buildings and colleges data. These layers need to build the spatial and attribute data that are necessary for the acquiring and management function executions. Fig 4.2 illustrates the GIS layer structure and hierarchy.

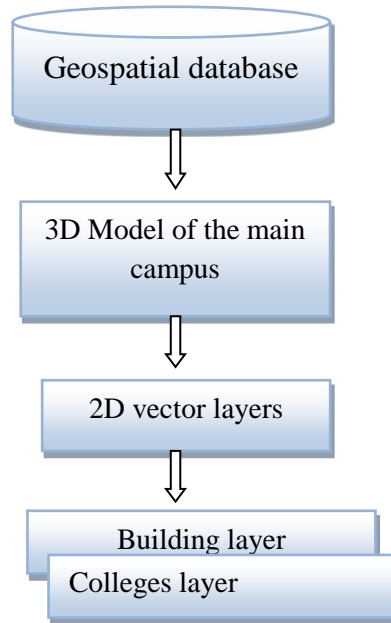

Fig. 4.2: GIS Layer Structure and Hierarchy.

The following section deals with a detailed workflow and methodology used for 3D GIS building visualizations for SUSTECH. The GIS data modeling part is an important step to build a 3D Model starting from data acquisition, either its semantic data or photogrammetry data, to create a virtual reality 3D model with geospatial database layers. Fig. 4.3 shows the workflow of 3D visualization model.

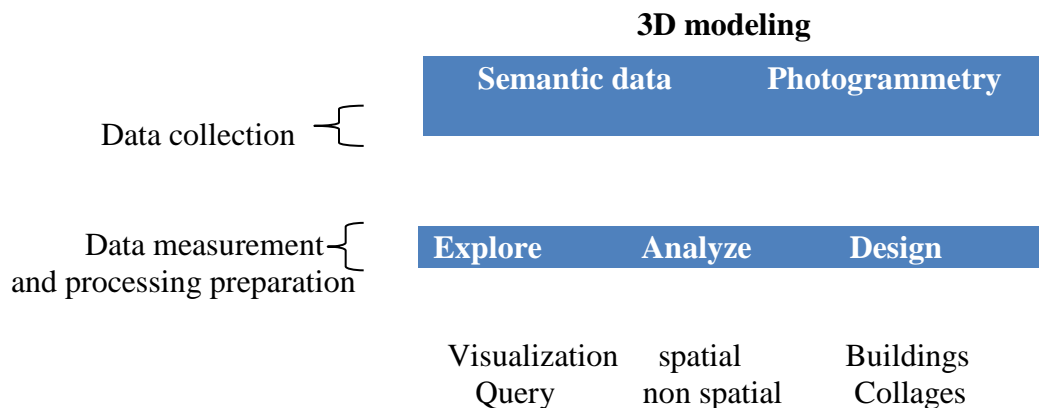

Fig. 4.3: The workflow to build a 3D model.

The overall methodological steps are graphically represented in Fig. 4.4. As illustrated in this figure, the methodology consists of several steps. Starting from gathered data that is used to build the 3D model for SUSTECH, photogrammetric methods are carried out to extract the point clouds from the photos. Furthermore 2D maps are utilized to create a planimetric campus database, specifying target areas and parameters for simulations. Finally, the 3D GIS model comprises three layers: the colleges layer, the buildings layer and the 3D layer of SUSTECH refined by texture mapping.

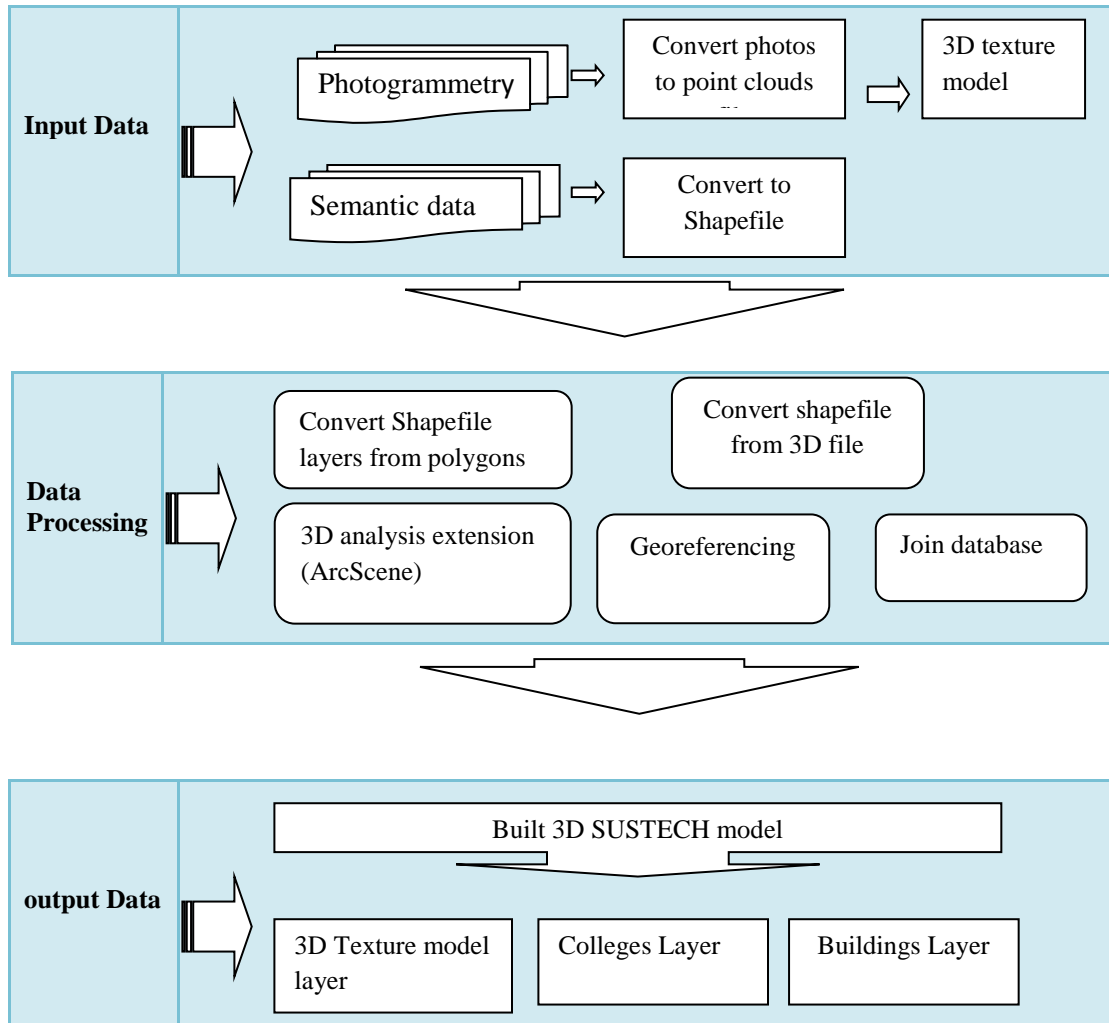

Fig. 4.4: Schematic diagram of the methodology study scenario to build a 3D data campus model.

Chapter 5

Simulations and Results

5.1 Photogrammetry

5.2 3D Model Reconstructions

Introduction

This chapter contains a full documentation of the main interfaces of the system, which has been ordered according to the implementation using 3D modelling software sequentially.

5.1 Photogrammetry

- A 3D model of the main campus is created. An excerpt of an aerial photo from Google Maps has been taken illustrating the region and location of SUSTECH (Figure 5.2).
- The first step of the study was getting the point clouds of the buildings from a collection of overlapping images using Dense Image Matching. To build the required 2D and 3D GIS information system, some data measurements and processing were applied.
- A set of overlapping images have been captured panoramically using a mobile phone camera as illustrated in figure 5.1.

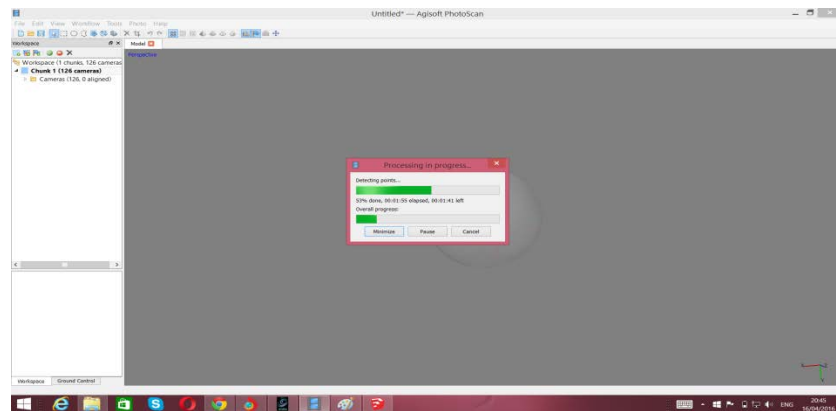

Figure 5.1: Several Photos “scanning” the College of Computer Science and Information Technology.

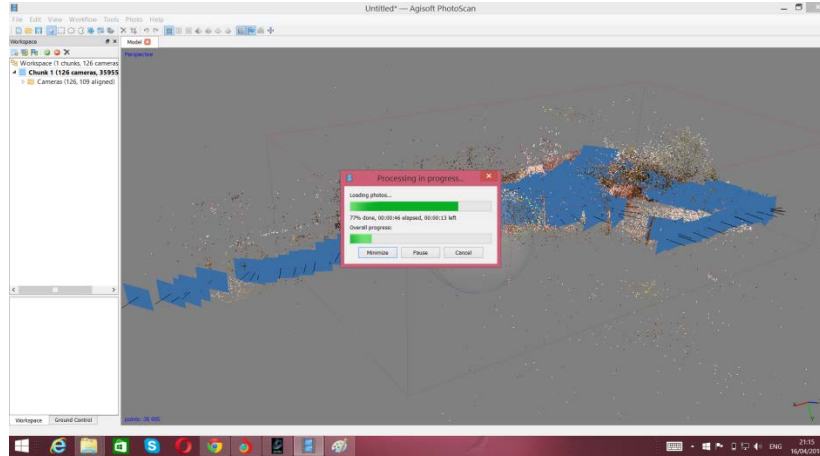

Figure 5.2: An Aerial Photo Excerpt illustrating the Geographical Location of SUSTECH.

Fig. 5.3 demonstrates the use of AgiSoft’s Photoscan software for the pose estimation and dense image matching.



(A)



(B)

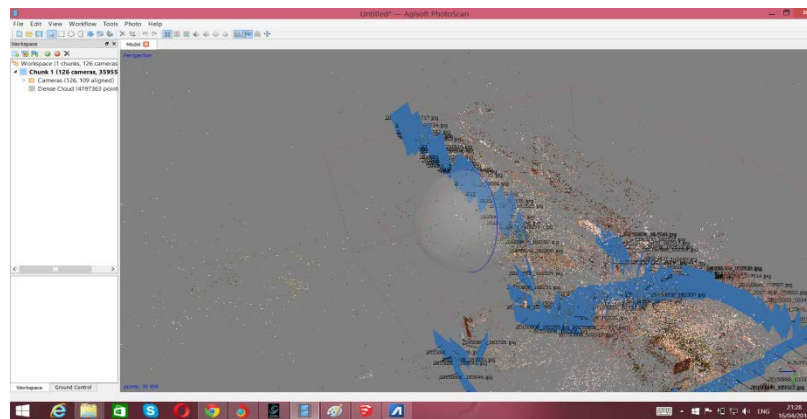

(C)

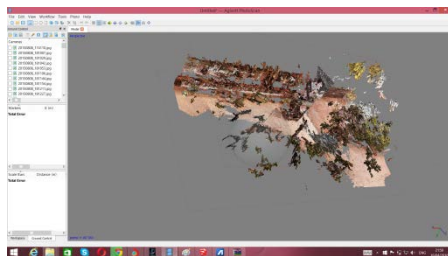

(D)

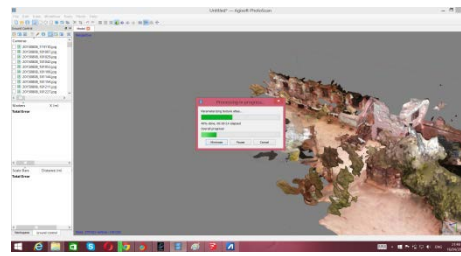

(E)

Fig 5.3: AgiSoft Image Processing: (A): illustrating aligning photos and detecting points. (B): illustrating dense image matching. (C): showing the point clouds. (D): dense model of point clouds points. (E): soled model of faculty of CSIT.

In this phase a point cloud file has been exported in Las format using AgiSoft's PhotoScan software for the generation of 3D building models as next step.

5.2 3D Model Reconstruction

Reconstructing a 3D model is a combination of several processes or phases. 3D and 2D vector and raster data were created for the Region of Interest (RoI) using Trimble's SketchUp pro software and Esri's ArcGIS.

❖ SketchUp

Sketch up software works well for texture mapping and allows to customize and duplicate any shape or repeated pattern. This procedure is useful for creating virtual reality models.

The first step with SketchUp was importing the point cloud files and customizing the objects by filling gaps and clarifying building details and refining, as shown in Fig. 5.4.

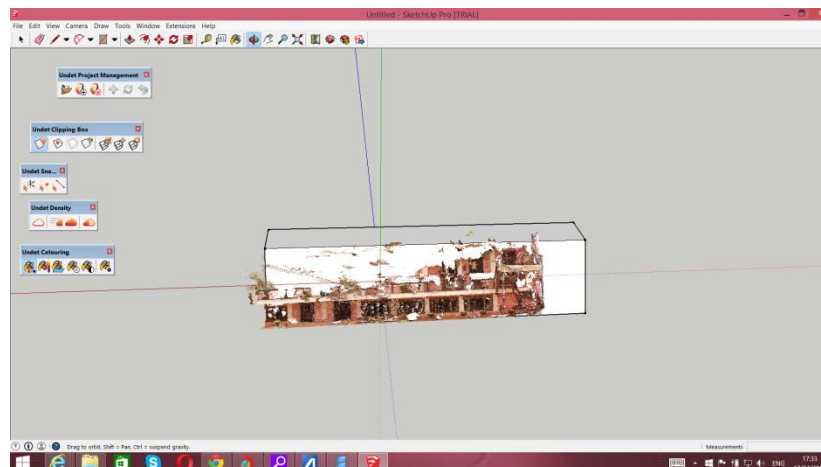

(A)

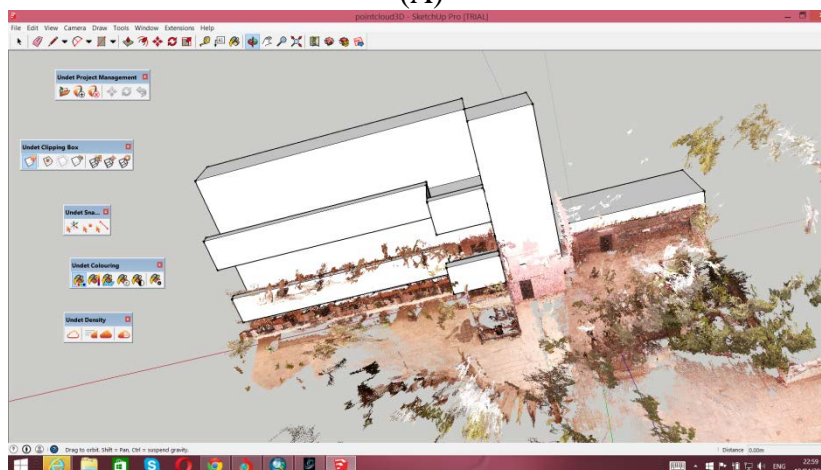

(B)

Figure 5.4: (A),(B) Using SketchUp with Undet Extension for Model Reconstruction and Refining for CSIT.

Undet Extension package was used for importing the point cloud (las format) files and adjusting objects as illustrated in Fig. 5.4. This works well with SketchUp (2015/2016 version) as an extension for importing numerous point cloud files, resulting from airborne LiDAR, Mobile Mapping Systems, Terrestrial Scanners, Handheld Scanners or Photogrammetry.

The 2nd step was adding texture for the model to be built by customized point clouds. SketchUp synthetic textures and image textures were used to guarantee better visualization and true virtual reality. This is demonstrated in Fig (5.5) and Fig (5.6).



Fig. 5.5: Image Texture for Faculty of Applied Arts.





Fig. 5.6: Captured Images for Texture Mapping illustrating Paintings, Sculptures and Arabic Font Art from the Faculty of Applied Arts.



Fig. 5.7: Final SketchUp result for SUSTECH 3D Model form different views.

A 3D model has been extracted from this phase as a final textured model as shown in Fig (5.7) - the output from this step is a 3D file in *.dae format.

❖ **ArcGIS (Arcscene).**

ArcGIS is one of (COTS) softwares, that allow for emitting reality and building 3D geometric, vector and raster layers, and to provide geo-referencing. Analyses help in decision making.

This step is concerned with extruding 3D buildings for 2D building vector layers – the results are 3D models, 3D buildings and the Colleges layer, as shown in Fig (5.8). Here a suitable coordinate system has to be chosen (vertical and horizontal) , for which we selected the World Geodetic System WGS 1984 UTM Zone 53N, covering Sudan. Finally the layers had to be converted to shapefiles as illustrated in Fig. 5.9.

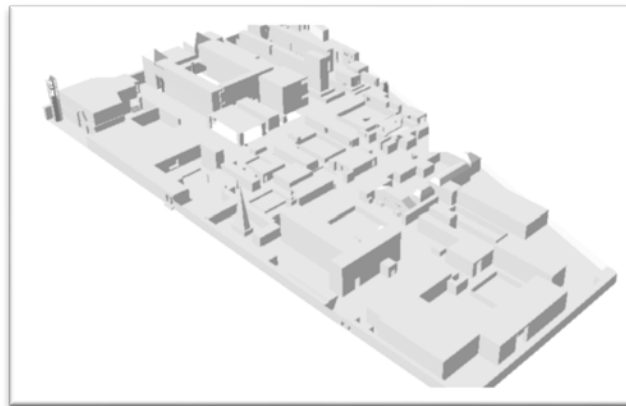

(A)



(B)



(C)

Fig. 5.8: The main model's layers (A) 3D Layer. (B) Buildings Layer. (C) Colleges Layer.

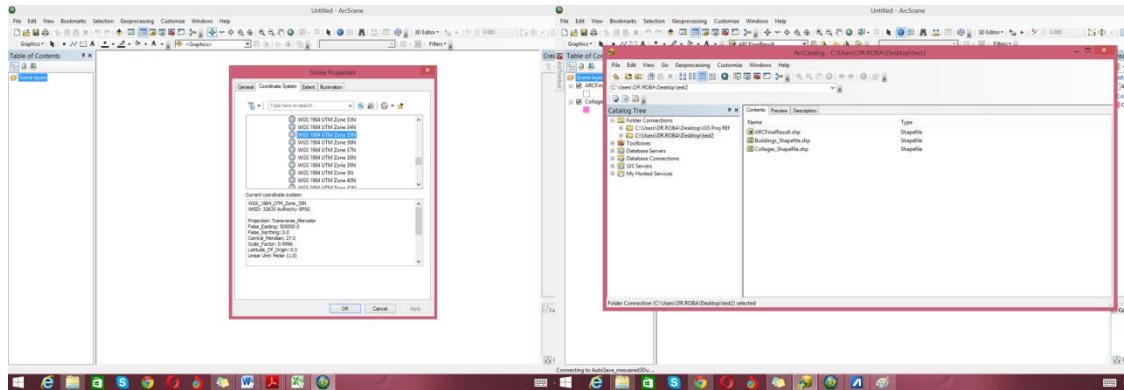

(A)

(B)

Fig. 5.9: (A) Coordinate System Specification. (B) Three main layers' shapefiles.

Building a geodatabase or layer's attribute table, which contains buildings and colleges information and can be provided by a mouse click is another challenge. The main attribute's tables and layering process is illustrated in Fig. 5.10.

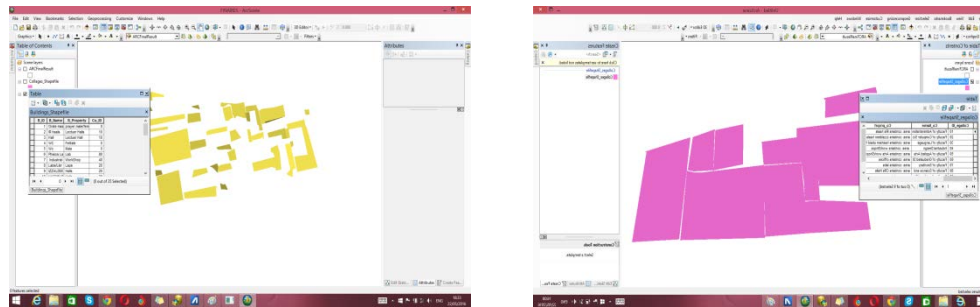

(A)

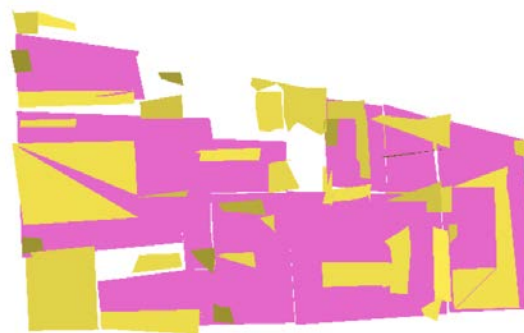

(B)

Fig. 5.10: (A) Layer's Attribute Tables. (B) Layering Process.

After adding geodata we can easily inquire about the objects or area inside the campus model and also provide orientations and navigations inside campus. Fig. 5.11 illustrates some samples of queries in an ArcScene environment.

A virtual reality model has been exported from this phase as (wrl) format file.in addition the VR model has been available to view on desktop and smartphones using sketchfab viewer. As in Fig.5.12.

The final result from the above illustrated phases is SUSTEH 3D model started from exporting point clouds and shapefiles to the final extracted VR file.

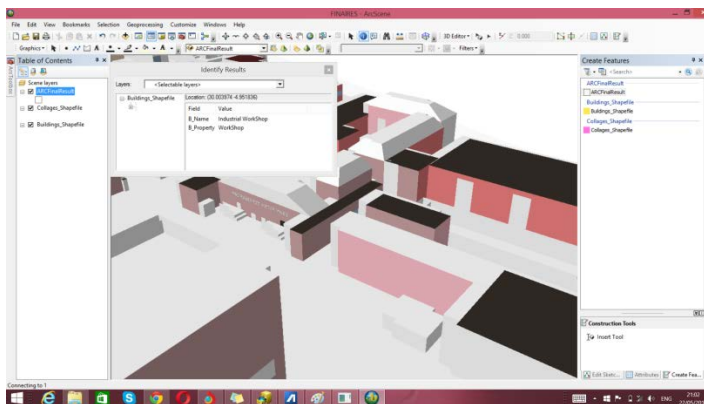
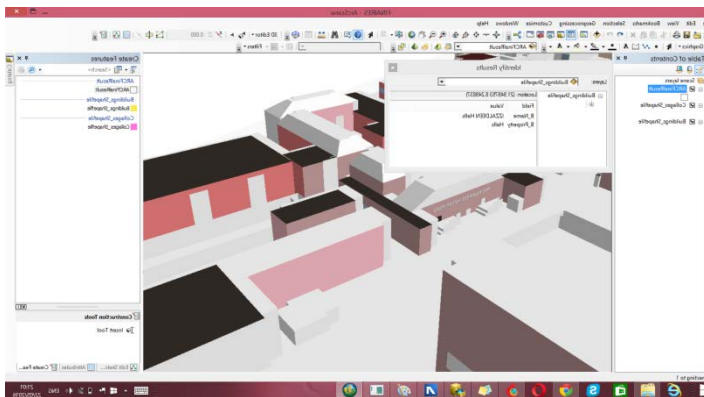
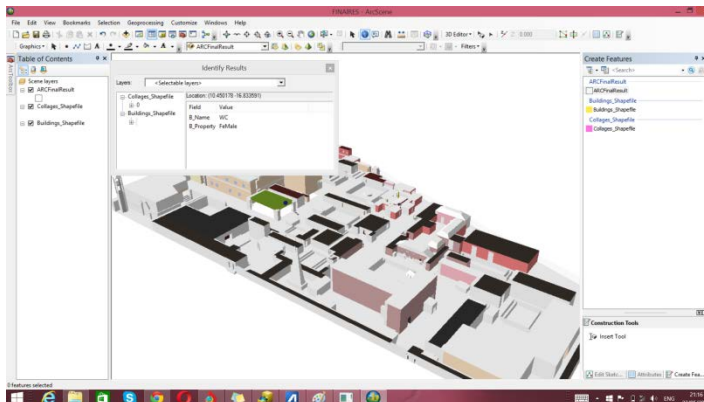
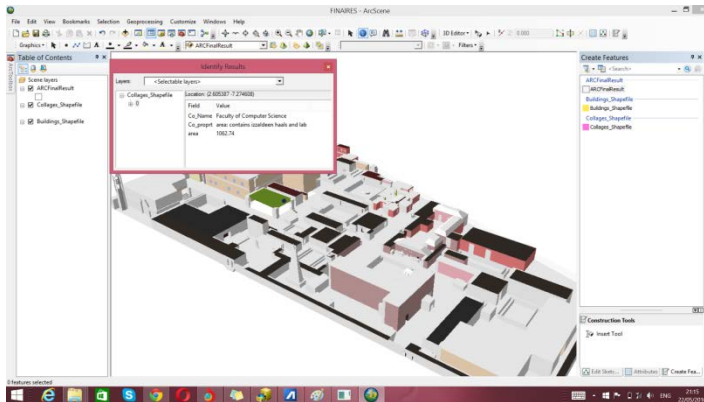

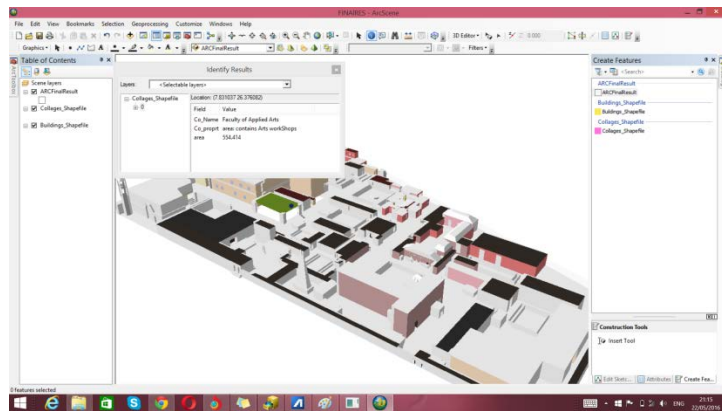
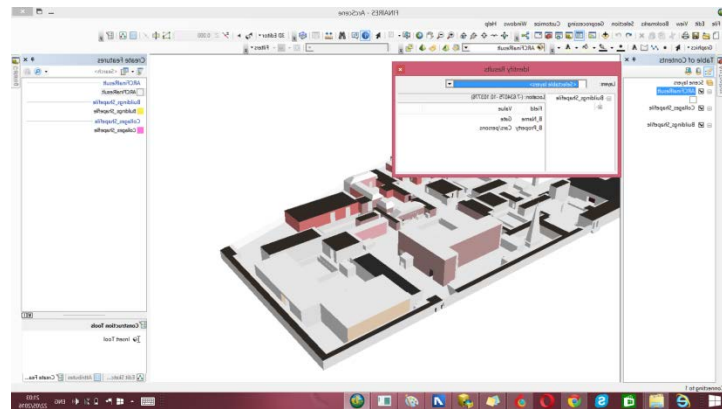
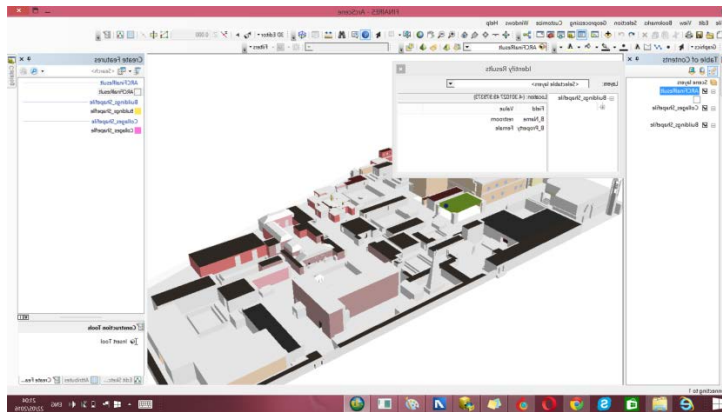
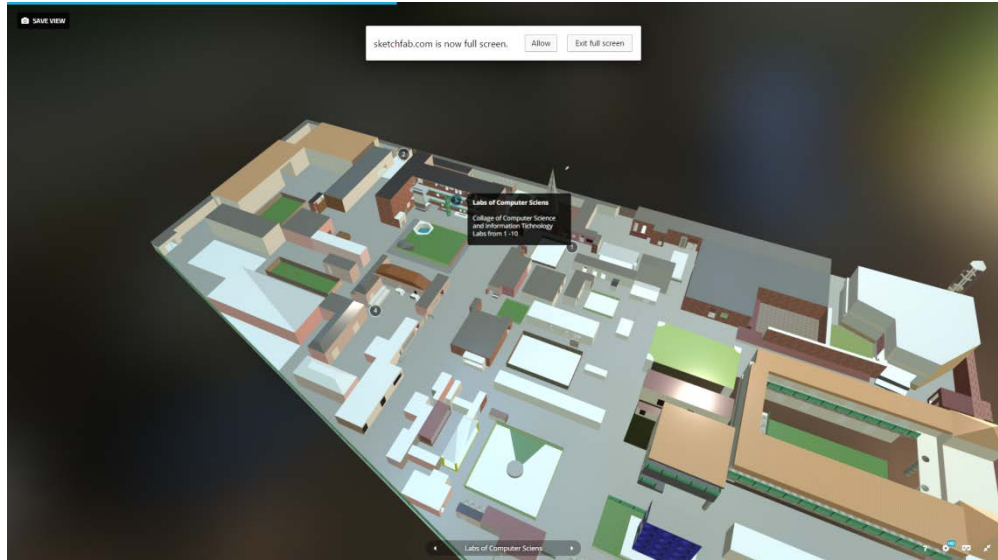
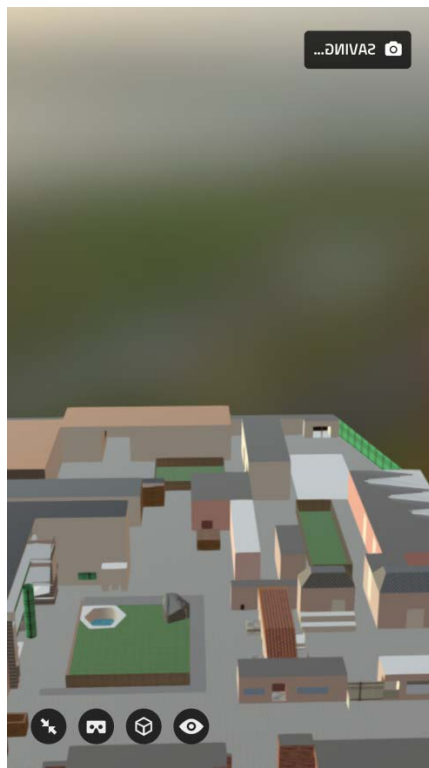

Fig. 5.11: Shows Various Types of Queries for SUSTECH VRM with Texture and Geodata.



(a) VR model from desktop .



(b) VR model from smartphone.

Fig.5.12 (a) (b) VR view on sketchfab viewer.

Chapter 6

Conclusions and Outlook

6.1 Conclusions

This work is the result of research that explores the effective use of 3D modeling in various applications. The thesis illustrates the feasibility of using photogrammetry and off-the-shelf softwares in 3D GIS modeling.

Virtual reality modeling is used to build for the SUSTECH campus a three-dimensional model with texture mapping that allows for virtual reality visualizations, orientations and navigations around the whole campus with georeferenced data and databases.

The approach used in this work presents a simple strategy that is suitable for the development of realistic views of buildings and the introduction of an accurate virtual reality environment.

This thesis is essentially aims to use GIS technology to guide students and visitors in their navigations over the university campus without wasting time and efforts.

6.2 Recommendations

For more efficient and real views the following suggestions are recommended:

1. Connecting SUSTECH 3D model directly with the university web site.
2. Take advantages of GPS properties for user positioning
3. Utilize GIS modeling for showing high level of building details, features and measurements.

Chapter 7

References

LIST OF SOURCES

[1] Agisoft LLC ,2013, “Agisoft PhotoScan User Manual”,Professional Edition, Version 1.0.0, pp 1.

[2] Al-Hanbali, N., 2007,” Texture Mapping and Implementation Aspects for 3D GIS Applications”, Research Paper of Al-Balqa Applied University, 12/2007, pp. 2-16.

[3] Al-Rawabdeh, A., Al-Ansari, N., Attya1, H. and Knutsson, S., 2014,” GIS Applications for Building 3D Campus, Utilities and Implementation Mapping Aspects for University Planning Purposes”, Journal of Civil Engineering and Architecture, ISSN 1934-7359, USA,pp 4-9.

[4]Henry, P. ,Krainin, M., Herbst, E., Ren, X., Fox,D., 2010, “RGB-D Mapping: Using Depth Cameras for Dense 3D Modeling of Indoor Environments “university of Washington , Intel Lab Seattle, pp. 1-3.

[5]Hogenboom.K., 2013, “Numeric and Spatial Data Librarian Scholarly Commons”, presentation of university of ILLNOIS AT URBANA CHAMPAIGN, pp. 4.

[6]Huisman,O., Rolf, A., 2009, ”Principles of Geographical Information Systems”, The International Institute Of Geo-Information Science and Earth Observation (ITC),2009, pp. 32-49.

[7] Münster, S., 2010, “Workflows and the role of images for virtual 3D reconstruction of no longer extant historical objects”, Dresden University of Technology, Germany , 9/2013, pp. 2-5 and pp. 198-201 .

[8] Remondino, F., El-Hakim, S. ,2006,”Image Based 3D Modelling”, The Photogrammetric Record, pp. 2-4.

[9] Schenk, T., 2005, “Introduction to Photogrammetry”. Ohio State University , Neil Ave, Columbus, pp.3-12.

[10] The University of Maryland Libraries,2012, ” Spatial Analysis Using ArcGIS 10”, user manual , pp 2.

References from Websites:

[11] “about sketchfab”(May 22, 2016),retrieve from <https://sketchfab.com/>

[12] “SketchUp Pro” , (May 22, 2016) retrieve from <http://www.reuters.com/article/us-trimble-google-idUSBRE83P0V820120426>.

تم
بحمد الله