

الأية

بسم الله الرحمن الرحيم

قال تعالى:

(قُلْ أَعْمَلُوا فِى سَبِيْلِ اللَّهِ عَمَلِكُمْ وَرِسَالَاتِ اللَّهِ وَمُؤْمِنُونَ)

صدق الله العظيم

التوبة (105)

الاهداء:

اننا نحمد الله على منه و فضله علينا بانجاز هذا العمل و نرجو تقبله و جعله خالص
لوجهه الكريم و نشكره على توفيقه

نهدي هذا العمل الذي نرجو ان يكون مساهمة ضئيلة في مجال البحوث العلميه و
نرجو ان يكون بدايه لتوجه لدراسه الطاقات المتجدده عموما و توربينات التوليد
المائي

الى من كابدت و تعبت من اجل ان اصل الى هذا العمل المتقبل باذن الله بصبرها
علي و دعواتها في الليالي من اجل توفيقني

و الي ابي ذلك الشخص الرائع الذي لم يتوقف عن دعمي و لم تنل من ثقته في اي
نائله

الى استاذنا الرائع الذي لم يبخل لنا بعلمه و لا وقته و ندعو الله ان يجزيه عنا خير
الجزاء و ان يوفقه و هو القادر على ذلك

الاستاذ: الصديق عبدالعظيم بابكر احمد

الى اخوتي الذين وقفوا وراءنا داعميننا لنا و ناصحين لنا بخبرتهم و مجهودهم و لهم
منا خالص الشكر و العرفان

ABSTRACT

The poor power generation in Sudan during summer is caused by the low levels of water flow thus low water head in dams causing them to stop or lower their power generation. The Jabal Awlia dam is an example.

A small Kaplan turbine has been designed in order to generate 100KW of power from a water head of 3m, and a hydraulic efficiency of 0.9. Used in the design process were Solidworks for modeling and the Ansys program for the analysis of stresses, strains, and deformation on three different materials, which are Copper, Structural steel, and Stainless steel.

Stainless steel was found to be the most suitable for the design due to its high resistance against cavitations and rust, and with a yield stress of 250 MPa,

The main dimensions of the turbine (the hub, runner blades, and guide vanes) were calculated and therefore the hub diameter of the turbine is found to be 0.19m, the runner diameter is 0.63m, with a specific speed of 1.42.

المستخلص

تم تصميم نموذج لتوربينة كابلين (ريش التوجيه, الريش الدوارة والصرة) لتوليد 100 كيلوواط من الطاقة ويعمل على ارتفاع سم 3متر وكفاءة هيدروليكية 0.9. وقد تم اقتراح كابلين ليحل محل توربينة فرانسيس في سد جبل اولياء. وذلك نظرا الى انخفاض مناسب مياه النيل في فترة الصيف مما يؤدي الى توقف الخزان عن انتاج الكهرباء.

وقد استخدم برنامج Solidwork لرسم النموذج وبرنامج انسيس لإيجاد كل من الإجهاد والإنفعال والتشوه في المعادن المختبرة في أقطار 0.63متر للريشة و0.19متر للصرة واختير Stainsteel كأفضل معدن للتصميم.

Table of Contents:

Title		Page
الايه		i
Dedication		ii
Abstract		iii
الخلاصة		iv
Table of contents		v
List of Tables		viii
List of Figures		ix
List of Abbreviations		x
Chapter One		
Introduction		
1-1	Introduction	2
1-2	Problem statement	3
1-3	Objective	3
1-4	Research scope	4
1-5	Project layout	5
Chapter Two		
Literature review		
2-1	Preface	7
2-2	History of Hydraulic Turbines	7
2-3	Classification of Hydraulic Turbines	8
2-3-1	Impulse turbine	8
2-3-2	Reaction turbine	9
2-3-2-1	The main types of reaction turbine	9
2-3-2-2	The main component of reaction turbine	11
2-3-1 -1	Advantages of impulse turbine	11
2-4	Pelton turbine	13
2-4-1	Functions of Pelton	13
2-4-2	Application of Pelton	14
2-5	Francis turbine	15
2-5-1	Operational method	16
2-5-2	Application of Francis	17
2-5-3	Advantages of Francis	17
2-5-4	Disadvantages of Francis	18
2-6	Kaplan turbine	19

2-6-1	Development	19
2-6-2	Principles	20
2-6-3	Range of use	20
2-6-4	theory Operation	21
2-6-5	Application	22
2-7	Variation	23
2-7-1	Comparison between turbines	24
2-8	Cavitations	25
2-9	Efficiencies	26
2-10	Specific speed	38
Chapter Three Research Methodology		
3-1	Methodology	31
3-2	Solidwork software designing program	32
3-3	Modeling method	32
3-4	Building and model in solidwork	33
3-5	Step of Kaplan turbine	34
3-6	Calculation	37
Chapter Four Results&Discussions		
4-1	Fixed support	44
4-2	Pressure	45
4-3	Mesh	46
4-4	Copper	47
4-4-1	The maximum and minimum stress	47
4-4-2	Maximum and minimum strain	48
4-4-3	Maximum and minimum deformation	49
4-5	Structure steel	50
4-5-1	The maximum and minimum strain	50
4-5-2	Maximum and minimum stress	51
4-5-3	Maximum and minimum deformation	52
4-6	Stainless steel	53
4-6-1	The maximum and minimum strain	53

4-6-2	Maximum and minimum stress	54
4-6-3	Maximum and minimum deformation	55
4-7	Compare between material	56
Chapter Five Conclusion & Recommendations		
5-1	Conclusion	60
5-2	Recommended	61
	References	62

List of Table:

2-1	Comparison between Pelton, Francis, and Kaplan	32
3-1	Solidwork Commands	36
4-1	Comparing between chosen materials	65

List of Figures:

2-1	Parts of pelton turbine	14
2-2	Parts of francis turbine	16
2-3	Sectional view of Kaplan turbine	20
2-4	Kaplan turbine selection chart	21
2-5	Vertical Kaplan turbine	22
2-6	Comparison between Kaplan, Francis and Pelton	25
2-7	Cavitation	27
2-8	Efficiency vs Specific speed	29
3-1	The startup page of solidworks program	35
3-2	Main face of solidwork	35
3-3	Choose suitable plane	36
3-4	Final design	37
3-5	Final design	41
3-6	Inlet velocity triangle	
4-1	Fixed support	46
4-2	Pressure	47
4-3	Mesh	48
4-4	Copper elastic strain	49
4-5	Stress	50
4-6	Deformation	51
4-7	Structure steel elastic strain	52
4-8	Stress	53
4-9	Deformation	54
4-10	Stainless steel elastic steel	55
4-11	Stress	56
4-12	Deformation	57
4-13	Yield stress	59
4-14	Max/Min stress	59
4-15	Max/Min strain	60
4-16	Deformation	60

List of Abbreviation:

A	Area
Q	Discharge
V	Primary
P	Power
Q	Water Density
G	Gravity
NQE	Specific Sped
H	Head
E	Specific Hydraulic Energy
H_n	Net Head
N_{max}	Runner Speed
N	Rotation Speed
k_{ug}	constant
D_{ego}	Diameter of Guide Vans
F	Force
D_e	Runner diameter
D_i	Hub diameter

Chapter 1

Chapter One

1-1 Introduction:

Renewable energy is generally defined as energy that is collected from resources which are naturally replenished on a human timescale, such as sunlight, wind, rain, tides, waves, and geothermal heat. Renewable energy often provides energy in four important areas: electricity generation, air and water heating/cooling, transportation, and rural (off-grid) energy services

By taking advantage of gravity and the water cycle, we have tapped into one of nature's engines to create a useful form of energy. In fact, humans have been capturing the energy of moving water for thousands of years. Today, harnessing the power of moving water to generate electricity, known as hydroelectric power, is the largest source of emissions-free, renewable electricity worldwide.

There are a variety of types of turbines used at hydropower facilities, and their use depends on the amount of hydraulic head (vertical distance between the dam and the turbine) at the plant. The most common are Kaplan, Francis, and Pelton wheel designs. Some of these designs, called reaction and impulse wheels, use not just the kinetic force of the moving water but also the water pressure.

The Kaplan turbine is similar to a boat propeller, with a runner (the turning part of a turbine) that has three to six blades, and can provide up to 400 MW of power. The Kaplan turbine is differentiated from other kinds of hydropower turbines because its performance can be improved by changing the pitch of the blades.

The Francis turbine has a runner with nine or more fixed vanes. In this turbine design, which can be up to 800 MW in size, the runner blades direct the water so that it moves in an axial flow.

The Pelton turbine consists of a set of specially shaped buckets that are mounted on the outside of a circular disc, making it look similar to a water wheel. Pelton turbines are typically used in high hydraulic head sites and can be as large as 200 MW.

Hydroelectric power production started in Sudan in the beginning of the twentieth century. In 1926 the Sinnar dam was built, which gave a boost to Sudan's overall economy and power production. Since then, six more power stations were constructed. Almost half of Sudan's power output is supplied by the 280 MW hydro-electric plants that is found at the Roseires dam.

The turbines used in most hydroelectric stations in Sudan are Francis turbines, for example the powerhouse in Merowe dam is equipped with ten 125 megawatts (168,000 hp) Francis turbines.

But due to the Landscape and environmental conditions in Sudan, Kaplan turbines are being considered because of their technical and mechanical properties.

1-2 Problem statement:

There is no power generation in JabalAwliadam during summer due to low water head in the lake. Kaplan turbine which is not used in Sudan is designed as a solution for its advantage over Francis as it operates at lower water heads.

1-3 Objectives:

The aim of this project is to design a Kaplan turbine for use in JabalAwlia dam.

The specific objectives are:

1. Design of the turbine parts (guide vans, runner vans, and the hub)
2. Modeling of the turbine
3. Analysis of the turbine with three different materials (copper, stainless steel, structure steel)

1-4 ProjectScope:

Design Kaplan turbine (guide vans, blade and hub) to generate 100kw by using solid works and ansys to make static analysis.

1-5 Project layout

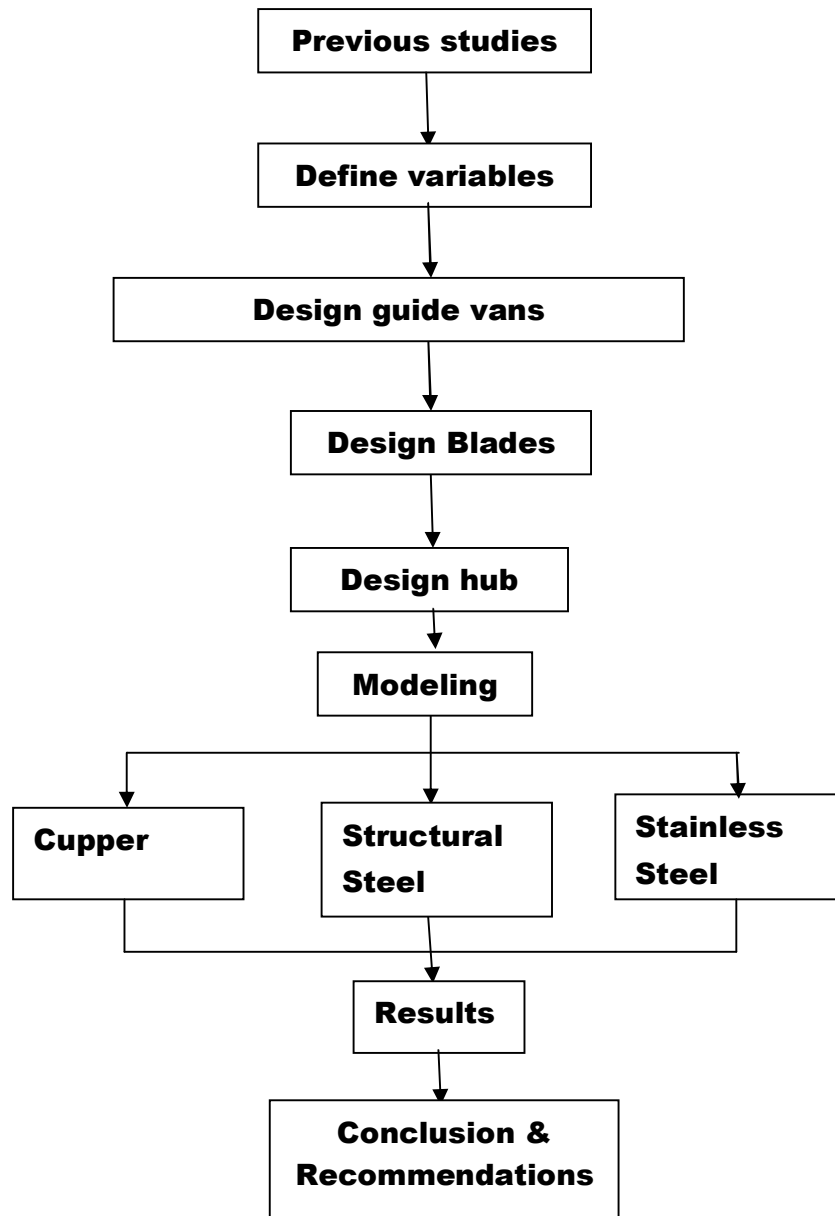

Chapter 2

Chapter Two

2.1 Preface:

The demand for increasing the use of renewable energy has risen over the last few years due to environmental issues. The high emissions of greenhouse gases have led to serious changes in the climate. Although the higher usage of renewable energy would not solve the problems overnight, it is an important move in the right direction. The field of renewable energy includes, for example wind power, solar power and waterpower. The first use of waterpower as an energy source dates back centuries. The energy was utilized, for instance, to grinding grain. The applied machinery for this purpose was based on simple water wheels. Over the years the machinery has been developed and become more and more advanced. Hydropower was the first renewable source which was used to generate electricity over 100 years ago. Today, hydropower is an important source of producing electrical energy; approximately 20% of the world electricity is supplied by hydroelectric power plants.

Depending on the head and discharge of the sites, the hydroelectric power plant has to be equipped with a specific turbine in order to get the highest efficiency. There are several different kinds of water turbines and can be divided into impulse and reaction turbines. An impulse turbine is where the water pressure is transformed into kinetic energy before the water reaches the runner of the turbine. The energy hits the runner in a form of a high-speed jet. A turbine, where the water pressure applies a force on the face of the runner blade is called a reaction turbine.

2.2 History of Hydraulic Turbines:

- Water wheels – China and Egypt – thousands of years ago.
- Reaction runner – J A Segnar – 1950.

- Euler turbine theory – Leonard Euler – valid till today
- Turbine is a designation that was introduced in 1824 in a dissertation of the French engineer Burdin.
- Fourneyron designed a radial turbine and put to operation the first real turbine in 1827 – power 20-30kW and runner diameter of 500 mm
- Henschel and Jonval in 1840 independently developed turbine with axial water flow through it. They were the first ones to apply draft tube and in that way to utilize the water head between runner outlet and tail water level.
- Francis in 1849 developed the radial turbine, named Francis turbine.

In 1870 professor Fink introduced an important improvement in Francis turbine by making the guide vanes turning on a pivot in order to regulate the flow discharge.

- In 1890 American engineer Pelton developed impulse turbine, named Pelton Turbine.
- In 1913 Kaplan designed a propeller turbine, named Kaplan turbine
- Subsequent developments were made on Francis, Pelton and Kaplan turbines.

2.3 Classification of Hydraulic Turbines:

Hydraulic turbines are generally classified as

- Impulse Turbine – Pelton, Turgo turbine
- Reaction Turbine – Francis, Kaplan and Propeller turbine

2.3.1 Impulse turbines:

- The flow energy to the impulse turbines is completely converted to kinetic energy before transformation in the runner.
- The impulse forces being transferred by the direction changes of the flow velocity vectors when passing the buckets create the energy converted to mechanical energy on the turbine shaft.

- The flow enters the runner from jets spaced around the rim of the runners. The jet hits momentarily only a part of the circumference of the runner.

Based on flow direction, they are further classified as:

- Tangential Flow
- Radial Flow
- Axial Flow
- Mixed Flow

2.3.2 Reaction turbine:

- Pressure drop takes place in the turbine itself.
- Water flow completely fills all part of the turbine.
- Pivot able guide vanes are used for control (Francis).
- A draft tube is normally added on to the exit; it is considered an integral part of the turbine.

Reaction turbines are those turbines which operate under hydraulic Pressure energy and part of kinetic energy. In this case, the water reacts with the vanes as it moves through the vanes and transfers its pressure energy to the vanes so that the vanes move in turn rotating the runner on which they are mounted.

2.3.2.1 The main types of reaction turbines are:

1. Radically outward flow reaction turbine:

This reaction turbine consist a cylindrical disc mounted on a shaft and provided with Vanes around the perimeter. At inlet the water flows into the wheel at the center and then glides through radically provided fixed guide vanes and then flows over the moving vanes. The function of the guide vanes is to direct or guide the water into the moving vanes in the correct direction and also

regulate the amount of water striking the vanes. The water as it flows along the moving vanes will exert a thrust and hence a torque on the wheel thereby rotating the wheel.

The water leaves the moving vanes at the outer edge. The wheel is enclosed by a water-tight casing. The water is then taken to draft tube.

2. Radically inward flow reaction turbine:

The constitutional details of this turbine are similar to the outward flow turbine but for the fact that the guide vanes surround the moving vanes. This is preferred to the outward flow turbine as this turbine does not develop racing.

The centrifugal force on the inward moving body of water decreases the relative velocity and thus the speed of the turbine can be controlled easily.

3. Mixed flow reaction turbine:

This is a turbine wherein it is similar to inward flow reaction turbine except that when it leaves the moving vane, the direction of water is turned from radial at entry to axial at outlet. The rest of the parts and functioning is same as that of the inward flow reaction turbines.

4. Axial flow reaction turbine:

This is a reaction turbine in which the water flows parallel to the axis of rotation. The shaft of the turbine may be either vertical or horizontal. The lower end of the shaft is made larger to form the boss or the hub. A number of vanes are fixed to the boss. When the vanes are composite with the boss the turbine is called propeller turbine. When the vanes are adjustable the turbine is called a Kaplan turbine.

2.3.3 Impulse turbines:

An impulse turbine is one having one or more free jets discharging into an aerated space and impinging on the buckets of a runner. Efficiencies are often 90 percent and above.

➤ **Advantages of impulse turbines:**

Impulse turbines are generally more suitable for micro-hydro applications compared with reaction turbines because they have the following advantages:

- Greater tolerance of sand and other particles in the water,
- Better access to working parts,
- No pressure seals around the shaft,
- Easier to fabricate and maintain,
- Better part-flow efficiency

2.4 The main component parts of a reaction turbine are:

(1) Casing, (2) Guide vanes (3) Runner with vanes (4) Draft tube

➤ **Casing:**

This is a tube of decreasing cross-sectional area with the axis of the tube being of geometric shape of volute or a spiral. The water first fills the casing and then enters the guide

Hydraulics and Hydraulic Machines. Sides radially inwards. The decreasing cross-sectional area helps the velocity of the entering water from all sides being kept equal. The geometric shape helps the entering water avoiding or preventing the creation of eddies.

➤ **Guide vanes:**

Guide vanes is that vanes direct water to fall at the runner vanes with angle that give the most power output and it can be readjusted to have the right angle .

➤ **Runner with vanes:**

The runner is mounted on a shaft and the blades are fixed on the runner at equal distances. The vanes are so shaped that the water reacting with the m will pass through them there by passing their pressure energy to make it rotate the runner.

➤ **Draft tube:**

This is a divergent tube fixed at the end of the outlet of the turbine and the other end is submerged under the water level in the tail race. The water after working on the turbine, transfers the pressure energy there by losing all its pressure and falling below at atmospheric pressure. The draft tube accepts this water at the upper end and increases its pressure as the water flows through the tube and increases more than atmospheric pressure before it reaches the tailrace.

➤ **Spiral casing:**

The spiral casing around the runner of the turbine is known as the volute casing or scroll case. Throughout its length, it has numerous openings at regular intervals to allow the working fluid to impinge on the blades of the runner. These openings convert the pressure energy of the fluid into momentum energy just before the fluid impinges on the blades. This maintains a constant flow rate despite the fact that numerous openings have been provided for the fluid to enter the blades, as the cross-sectional area of this casing decreases uniformly along the circumference.

2.4 Pelton turbine:

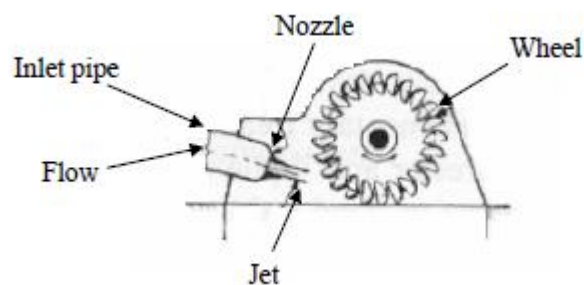

Figure (2-1) Parts of pelton turbine

The Pelton wheel is an impulse type water turbine. It was invented by Lester Allan Pelton in the 1870s. The Pelton wheel extracts energy from the impulse of moving water, as opposed to water's dead weight like the traditional overshot water wheel. Many variations of impulse turbines existed prior to Pelton's design, but they were less efficient than Pelton's design. Water leaving those wheels typically still had high speed, carrying away much of the dynamic energy brought to the wheels. Pelton's paddle geometry was designed so that when the rim ran at half the speed of the water jet, the water left the wheel with very little speed; thus his design extracted almost all of the water's impulse energy—which allowed for a very efficient turbine.

2.4.1 Function:

Nozzles direct forceful, high-speed streams of water against a rotary series of spon-shaped buckets, also known as impulse blades, which are mounted around the circumferential rim of a drive wheel—also called a runner (see photo, 'Old Pelton wheel..'). As the water jet impinges upon the contoured bucket-blades, the direction of water velocity is changed to follow the contours of the bucket. Water impulse energy exerts torque on the bucket-and-wheel system, spinning the wheel; the water stream itself does a "u-turn" and exits at the outer sides of the bucket, decelerated to a low velocity. In the process, the water jet's momentum is transferred to the wheel and thence to a turbine. Thus, "impulse" energy does work on the turbine. For maximum power and efficiency, the wheel and turbine system is designed such that the water jet velocity is twice the velocity of the rotating buckets. A very small percentage of the water jet's original kinetic energy will remain in the water, which causes the bucket to be emptied at the same rate it is filled, (see conservation of mass) and thereby allows the high-pressure input flow to continue uninterrupted and without waste of energy. Typically two buckets are

mounted side-by-side on the wheel, which permits splitting the water jet into two equal streams (see photo). This balances the side-load forces on the wheel and helps to ensure smooth, efficient transfer of momentum of the fluid jet of water to the turbine wheel.

Because water and most liquids are nearly incompressible, almost all of the available energy is extracted in the first stage of the hydraulic turbine. Therefore, Pelton wheels have only one turbine stage, unlike gas turbines that operate with compressible fluid.

2.4.2 Applications:

Pelton wheels are the preferred turbine for hydro-power, when the available water source has relatively high hydraulic head at low flow rates, where the Pelton wheel is most efficient. Thus, more power can be extracted from a water source with high-pressure and low-flow than from a source with low-pressure and high-flow, even when the two flows theoretically contain the same power. Also a comparable amount of pipe material is required for each of the two sources, one requiring a long thin pipe, and the other a short wide pipe. Pelton wheels are made in all sizes. There exist multi-ton Pelton wheels mounted on vertical oil pad bearings in hydroelectric plants. The largest units can be over 400 megawatts. The smallest Pelton wheels are only a few inches across, and can be used to tap power from mountain streams having flows of a few gallons per minute. Some of these systems use household plumbing fixtures for water delivery. These small units are recommended for use with 30 feet (9.1 m) or more of head, in order to generate significant power levels. Depending on water flow and design, Pelton wheels operate best with heads from 49–5,905 feet (14.9–1,799.8 m), although there is no theoretical limit.

2.5 Francis turbine (1868):

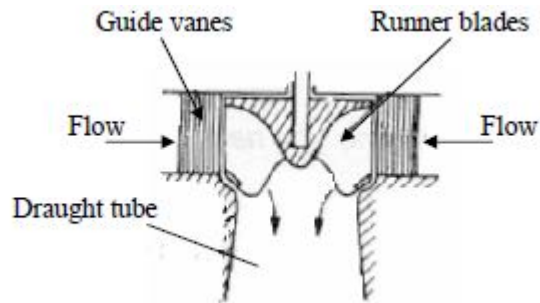

Figure (2-2) parts of Francis turbine

The Francis turbine is a reaction machine, the wheels are immersed and operate both on the water velocity (the kinetic energy) pressure difference. This type of turbine is located on the old low-head installation (less than 10m) where there are generally in water chamber without scroll case, their speed is very slow and adaptable to change if flow is relatively low. Currently the field of use of Francis is ideally located between 20-100 m for a head above 60 m. they are preferred to pelton when the flow is important.

The mechanical performance of a small Francis turbine for development is the laboratory is of the order 92%.

Francis turbines are the most common water turbine in use today. They operate in a water head from 40 to 600 m (130 to 2,000 ft) and are primarily used for electrical power production. The electric generators which most often use this type of turbine have a power output which generally ranges just a few kilowatts up to 800 MW, though mini-hydro installations may be lower. Penstock (input pipes) diameters are between 3 and 33 feet (0.91 and 10.06 meters). The speed range of the turbine is from 75 to 1000 rpm. Wicket gates around the outside of the turbine's rotating runner control the rate of water flow through the turbine for different

power production rates. Francis turbines are almost always mounted with the shaft vertical to isolate water from the generator. This also facilitates installation and maintenance.

.The guide vane mechanism along with the governors provides the regulation of the turbine output.

. The turbine governor controls the servomotor which transfers its force through a rod to the regulating ring. This ring transfers the movement to the guide vanes through a rod, lever and link construction.

.The guide vane exit area flow varied by equal rotation of each.

Guide vane exit area flow varied by equal of the guide vanes.

2.5.1 Theory of operation:

The Francis turbine is a type of reaction turbine, a category of turbine in which the working fluid comes to the turbine under immense pressure and the energy is extracted by the turbine blades from the working fluid. A part of the energy is given up by the fluid because of pressure changes occurring in the blades of the turbine, quantified by the expression of Degree of reaction, while the remaining part of the energy is extracted by the volute casing of the turbine. At the exit, water acts on the spinning cup-shaped runner features, leaving at low velocity and low swirl with very little kinetic or potential energy left. The turbine's exit tube is shaped to help decelerate the water flow and recover the pressure.

2.5.2 Application:

Francis turbines may be designed for a wide range of heads and flows. This, along with their high efficiency, has made them the most widely used turbine in the world. Francis type units cover a head range from 40 to 600 m (130 to 2,000 ft), and their connected generator output power varies from just a few kilowatts up to 800 MW.^[2] Large Francis turbines are individually designed for each site to operate with the given water supply and water head at the highest possible efficiency, typically over 90%.

In addition to electrical production, they may also be used for pumped storage, where a reservoir is filled by the turbine (acting as a pump) driven by the generator acting as a large electrical motor during periods of low power demand, and then reversed and used to generate power during peak demand. These pump storage reservoirs act as large energy storage sources to store "excess" electrical energy in the form of water in elevated reservoirs. This is one of a few methods that temporary excess electrical capacity can be stored for later utilization.

2.5.3 Advantages of Francis turbine are:

- Variation in the operating head can be easily controlled in Francis turbine
- The ratio of maximum and minimum operating head can be even be two in the case of Francis turbine.
- The operating head can be utilized even when the variation in the tail water level is relatively large when compared to the total load.
- The size of the runner, generator and power house required is small and economical if the Francis turbine is used instead of Pelton wheel for the same power generation.

2.5.4 Disadvantages of Francis turbine are:

- Water which is not clean can cause very rapid wear in high head Francis turbine. In passing through the guide vanes and cover facings, it can quickly reduce overall efficiency of the turbine by several percentages. The effect is much more serious in turbines of smaller diameter than in larger ones.
- The inspection and overhaul of a Francis Turbine is much more difficult job than that of the equivalent Pelton turbine.
- Cavitation is an ever present danger in Francis Turbine as well as in all the reaction turbines. The raising of the power house floor level to reduce the danger of flooding may be followed by the endless cavitation troubles.
- If there is a possibility of running below the 50% load for long time, the Francis will not lose efficiency but cavitation danger will become more serious.
- Difficult to maintain/clean.
- The water hammer effect with the Francis turbine is more difficult to reduce compared with action turbines.

2.6 Kaplan turbine:

2.6.1 Development:

Based on the principles of a Francis Turbine, the Kaplan Turbine was developed by the Austrian engineer Victor Kaplan towards the beginning of the 20th century. Due to its adjustable runner blades this turbine system is most adaptable to site conditions. The original version with vertical shaft and inlet spiral case is commonly used and the bulb turbine variant, which integrates generator in the casing, is used widely all over the world where the turbine and generator are fully submerged.

- Kaplan turbines have adjustable runner blades, that offers significant advantage to give high efficiency even in the range of partial load, and there is little drop in efficiency due to head variation or load.
- The runner blade operating mechanism consists of a pressure oil head, a runner servomotor and the blade operating rod inside the shaft, etc.
- The runner blades are operated to smoothly adjust their blade angles by a link mechanism installed inside the runner hub.

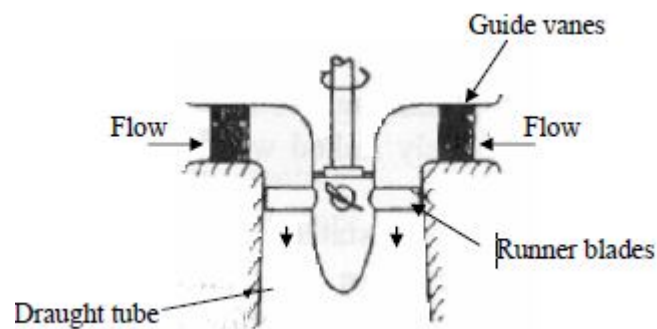

Figure(2-3) Sectional view of Kaplan turbine

2.6.2 Principle:

The Kaplan Turbine is of the reaction type where the runner is fully submerged and operates under pressure. At the inlet the velocity of the water steadily decreases, entering the guide vanes, passing through the runner and finally exiting the turbine after passing its energy to the generator. The water flow spirals in parallel down the turbine shaft and impinges on the fully admitted runner blades, where the flow is reduced further. The units are designed with specifically in order to prevent cavitations. Water flow is regulated by adjustable guide vanes. To achieve optimum efficiency at varying flows, the runner blades are automatically adjusted in relation to the wicket gate position.

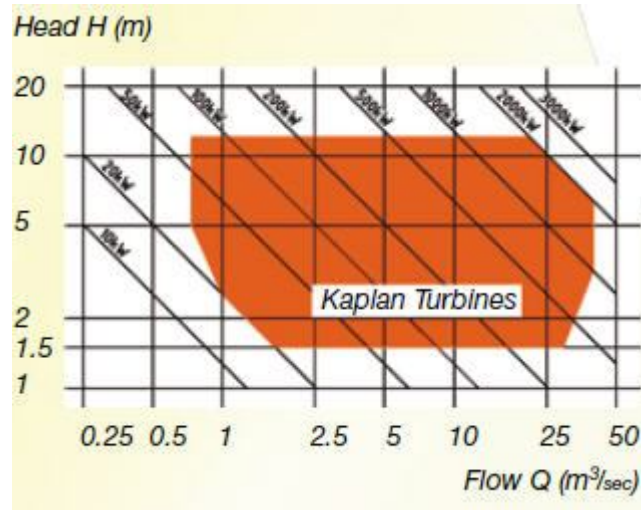

Figure (2-4) Kaplan turbine selection chart

2.6.3 Range of Use:

The Kaplan Turbine has an outstanding reputation for its high specific flow capacity. As a double-regulated turbine it is therefore most suitable for low heads and large flows, but also for variable head and flow conditions. It is ideally suited for sites with heads between 2 meters and 30 meters maximum.

2.6.4 Theory of operation:

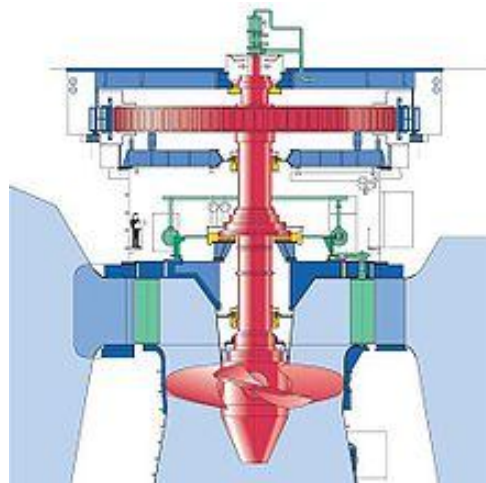

Figure (2-5) Vertical Kaplan Turbine

Kaplan turbine is an outward flow reaction turbine, which means that the working fluid changes pressure as it moves through the turbine and gives up its energy. Power is recovered from both the hydrostatic head and from the kinetic energy of the flowing water. The design combines features of radial and axial turbines.

The inlet is a scroll-shaped tube that wraps around the turbine's wicket gate. Water is directed tangentially through the wicket gate and spirals on to a propeller shaped runner, causing it to spin.

The outlet is a specially shaped draft tube that helps decelerate the water and recover kinetic energy.

The turbine does not need to be at the lowest point of water flow as long as the draft tube remains full of water. A higher turbine location, however, increases the suction that is imparted on the turbine blades by the draft tube. The resulting pressure drop may lead to cavitations.

Variable geometry of the wicket gate and turbine blades allows efficient operation for a range of flow conditions. Kaplan turbine efficiencies are typically over 90%, but may be lower in very low head applications.

Current areas of research include CFD driven efficiency improvements and new designs that raise survival rates of fish passing through.

Because the propeller blades are rotated on high-pressure hydraulic oil bearings, a critical element of Kaplan design is to maintain a positive seal to prevent emission of oil into the waterway. Discharge of oil into rivers is not desirable because of the waste of resources and resulting ecological damage.

2.6.5 Applications:

Kaplan turbines are widely used throughout the world for electrical power production. They cover the lowest head hydro sites and are especially suited for high flow conditions.

Inexpensive micro turbines on the Kaplan turbine model are manufactured for individual power production designed for 3 m of head which can work with as little as 0.3 m of head at a highly reduced performance provided sufficient water flow.

Large Kaplan turbines are individually designed for each site to operate at the highest possible efficiency, typically over 90%. They are very expensive to design, manufacture and install, but operate for decades.

They have recently found a new home in offshore wave energy generation, see Wave Dragon.

2.7 Variations:

The Kaplan turbine is the most widely used of the propeller-type turbines, but several other variations exist:

- Propeller turbines have non-adjustable propeller vanes. They are used in where the range of flow / power is not large. Commercial products exist for producing several hundred watts from only a few feet of head. Larger propeller turbines produce more than 100 MW. At the La Grande-1 generating station in northern Quebec, 12 propeller turbines generate 1368 MW

- Bulb or tubular turbines are designed into the water delivery tube. A large bulb is centered in the water pipe which holds the generator, wicket gate and runner. Tubular turbines are a fully axial design, whereas Kaplan turbines have a radial wicket gate.
- Pit turbines are bulb turbines with a gear box. This allows for a smaller generator and bulb.
- Starflower turbines are axial turbines with the generator outside of the water channel, connected to the periphery of the runner.
- S-turbines eliminate the need for bulb housing by placing the generator outside of the water channel. This is accomplished with a jog in the water channel and a shaft connecting the runner and generator.
- The VLH turbine an open flow, very low head "Kaplan" turbine slanted at an angle to the water flow. It has a large diameter $>3.55\text{m}$, is low speed using a directly connected shaft mounted permanent magnet alternator with electronic power regulation and is very fish friendly ($<5\%$ mortality).
- Tyson turbines are a fixed propeller turbine designed to be immersed in a fast flowing river, either permanently anchored in the river bed, or attached to a boat or barge.

Comparison between Francis, Pelton and Kaplan turbine:

Operating Ranges:

Table(2-1)

	Pelton turbine	Francis turbine	Kaplan turbine
Specific speed (rad)	0.05 – 0.4	0.4 – 2.2	1.8 – 5.0
Head (m)	100–1770	20–900	6–70
Maximum power (MW)	500	800	300
Optimum efficiency, per cent	90	95	94
Regulation method	Needle valve and deflector plate	Stagger angle of guide vanes	Stagger angle of rotor blades

The specification of turbines

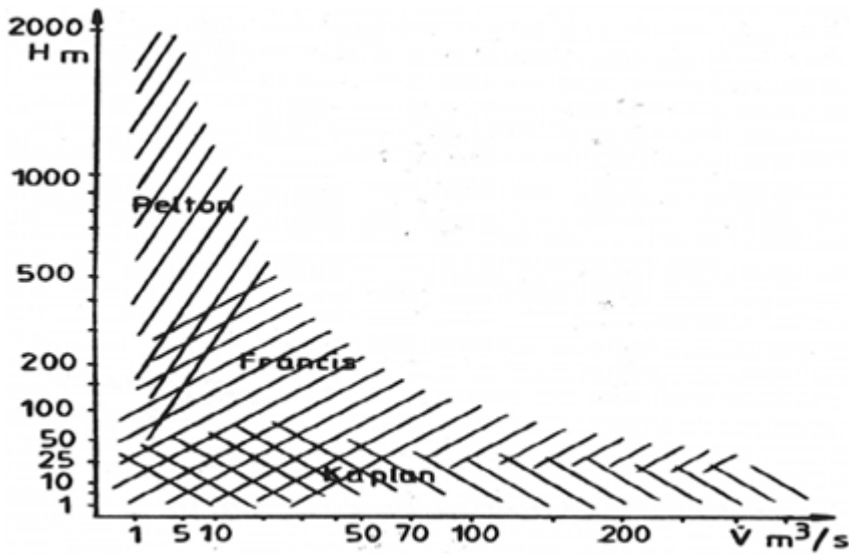

Figure (2-6) operating Ranges

2.8 Cavitations in Turbines:

- **Cavitations** is a term used to describe a process, which includes nucleation, growth and implosion of vapor or gas filled cavities.

These cavities are: formed into a liquid when the static pressure of the liquid for one reason or another is reduced below its vapor pressure at the prevailing temperature.

When cavities are carried to high-pressure region, they implode violently.

- cavitation is an undesirable effect that results in pitting, mechanical vibration and loss of efficiency.
- If the nozzle and buckets are not properly shaped in impulse turbines, flow separation from the boundaries may occur at some operating conditions that may cause regions of low pressure and result in cavitations.
- The turbine parts exposed to cavitations are the runners, draft tube cones for the Francis and Kaplan turbines and the needles, nozzles and the runner buckets of the Pelton turbines.
- Measures for combating erosion and damage under cavitations conditions include improvements in hydraulic design and production of components with erosion resistant materials and arrangement of the turbines for operations within good range of acceptable cavitations conditions.

Cavitation Process

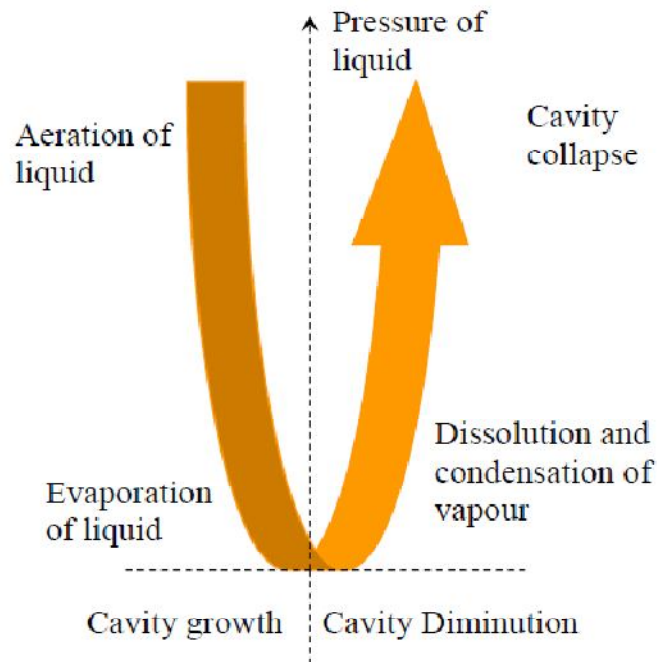

Figure (2-7) cavitationsprosses

2.9 Efficiencies of Hydraulic Turbines:

Various efficiencies of hydraulic turbines are:

- Hydraulic efficiency
- Volumetric efficiency
- Mechanical Efficiency
- Overall Efficiency

Hydraulic efficiency:

Efficiency in general is defined as the ratio of power delivered to the shaft (brake Power) to the power taken from water.

It is the ratio of the power developed by the runner to the water power available at the inlet of turbine.

Total available power of a plant is given by:

$$P_{available} = \rho Q g H_n \dots (2-1)$$

P	The total power output	(kwh)
Q	The quantity of flow	(m^3/s)
g	Gravity acceleration	(m/s^2)
H	The gross head of plant	(m)
ρ	The water density	(kg/m^3)
H_n	Net head	(m)

Power transfer from the fluid to the turbine runner is given by:

$$P_{shaft} = \rho Q (U_1 V_{u1} - U_2 V_{u2}) \dots (2-2)$$

U_1	Tangential velocity inlet	(m/s)
U_2	Tangential velocity outlet	(m/s)
V_{u1}	Wheel velocity inlet	(m/s)
V_{u2}	Wheel velocity outlet	(m/s)

The ratio of these two powers is given by:

$$\eta_{hydraulic} = \frac{Power_{shaft}}{Power_{available}} \quad \dots (2-3)$$

$$\eta_{hydraulic} = \frac{\rho Q (U_1 V_{u1} - U_2 V_{u2})}{\rho Q g H_n} \quad \dots (2-4)$$

$$\eta_{hydraulic} = \frac{(U_1 V_{u1} - U_2 V_{u2})}{g H_n} \quad \dots (2-5)$$

η Efficiency of turbine

The rearrangement of this equation gives the main turbine equation

$$\eta_{hydraulic} H_n = \frac{(U_1 V_{u1} - U_2 V_{u2})}{g} \quad \dots (2-6)$$

2.10 Specific Speed:

- It is defined as the speed of a turbine which is identical in shape, geometrical dimensions, blade angles, gate opening etc., with the actual turbine but of such a size that it will develop unit power when work in gunder unit head.
- This is the speed at which the runner of a particular diameter will develop kW (1 hp) power under 1 m (1 ft) head

- The specific speed is an important factor governing the selection of the type of runner best suited for a given operating range.

The impulse (Pelton) turbines have very low specific speeds relative to Kaplan turbines. The specific speed of a Francis turbine lies between the impulse and Kaplan turbine.

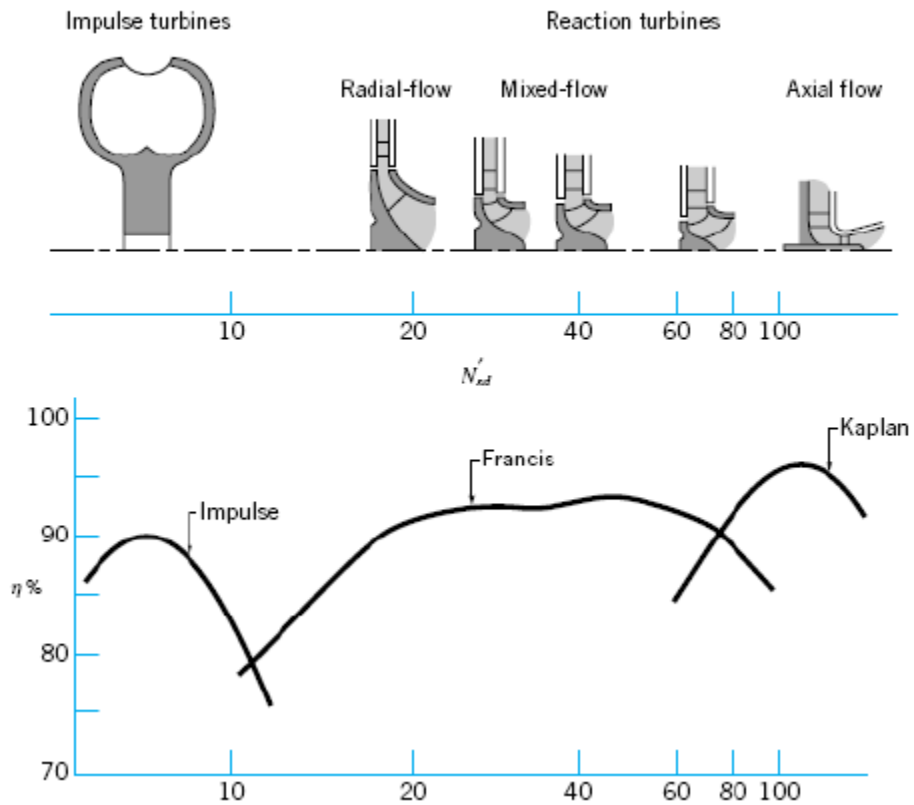

Figure(2-8) Efficiency vs. specific speed

Chapter 3

Chapter Three

3.1 Methodology:

- **Previous studies:**

Data on hydroelectric power plants and turbines had been collected from several references, scientific papers and specialized web sites, and then summarised compared, and noted.

- **Define variable:**

The variables that effect hydroelectric power plants efficiency and power output have been defined (discharge, head, velocity, pressure).

- **Design Guide vans:**

The dimensions and number of the blades are calculated according the head and discharge of water, efficiency and power output.

- **Design Blades:**

The dimensions and number of the blades are calculated according the head and discharge of water, efficiency and power output.

After designing the blades, the boss that holds them to the shaft is designed according their dimensions.

- **Design hub:**

After designing the blades, the hub that holds them to the shaft is designed according their dimensions.

- **Modeling:**

After the completion of the turbine parts designing, all parts are assembled together in one piece to form the model turbine strived to achieve.

- **Analysis:**

The model is then analyzed with ansys using three different materials.

- **Conclusion & Recommendations:**

All the data (readings, analysis, calculations, results, parameters, limitations) is noted and organized and the research results are presented

Design and Modeling:

Using solidwork software design program to design the Kaplan turbine part (guide vans, runner blades and hub), and ansys software program for the static analysis.

3.2 Solidwork software design program:

Is a solid modeling computer aided design (CAD) and computer aided engineering (CAE) computer program that runs on Microsoft windows Solidwork is published by dassaultsystemes.

3.3 Modeling method:

Solidwork is a solid modeler, and utilizes a parametric feature-based approach to create models and assemblies. The software is written on Para solid-kernel.

Parameters refer to constraints whose values determine the shape or geometry of the model or assembly. Parameters can be either numeric parameters, such as line lengths or circle diameters, or geometric parameters, such as tangent, parallel, concentric, horizontal or vertical, etc. Numeric parameters can be associated with each other through the use of relations, which allows them to capture design intent.

Design intent is how the creator of the part wants it to respond to changes and updates. For example, you would want the hole at the top of a beverage can to stay at the top surface, regardless of the height or size of the can. SolidWorks allows the user to specify that the hole is a feature on the top surface, and will then honor their design intent no matter what height they later assign to the can.

Features refer to the building blocks of the part. They are the shapes and operations that construct the part. Shape-based features typically begin with a 2D or 3D sketch of shapes such as bosses, holes, slots, etc. This shape is then extruded or cut to add or remove material from the part. Operation-based features are not sketch-based, and include features such as fillets, chamfers, shells, applying draft to the faces of a part, etc.

3-4 Building a model in SolidWorks:

Usually starts with a 2D sketch (although 3D sketches are available for power users). The sketch consists of geometry such as points, lines, arcs, conics (except the hyperbola), and splines. Dimensions are added to the sketch to define the size and location of the geometry. Relations are used to define attributes such as tangency, parallelism, perpendicularity, and concentricity. The parametric nature of SolidWorks means that the dimensions and relations drive the geometry, not the other way around. The dimensions in the sketch can be controlled independently, or by relationships to other parameters inside or outside of the sketch.

In an assembly, the analog to sketch relations are mates. Just as sketch relations define conditions such as tangency, parallelism, and concentricity with respect to sketch geometry, *assembly mates* define equivalent relations with respect to the individual parts or components, allowing the easy construction of assemblies. SolidWorks also includes additional advanced mating features such as gear and

cam follower mates, which allow modeled gear assemblies to accurately reproduce the rotational movement of an actual gear train.

Finally, drawings can be created either from parts or assemblies. Views are automatically generated from the solid model, and notes, dimensions and tolerances can then be easily added to the drawing as needed. The drawing module includes most paper sizes and standards.

3-5Steps for Kaplan turbine design by solidworks:

3-5-1First Step

Open the solid works program and choosenew part

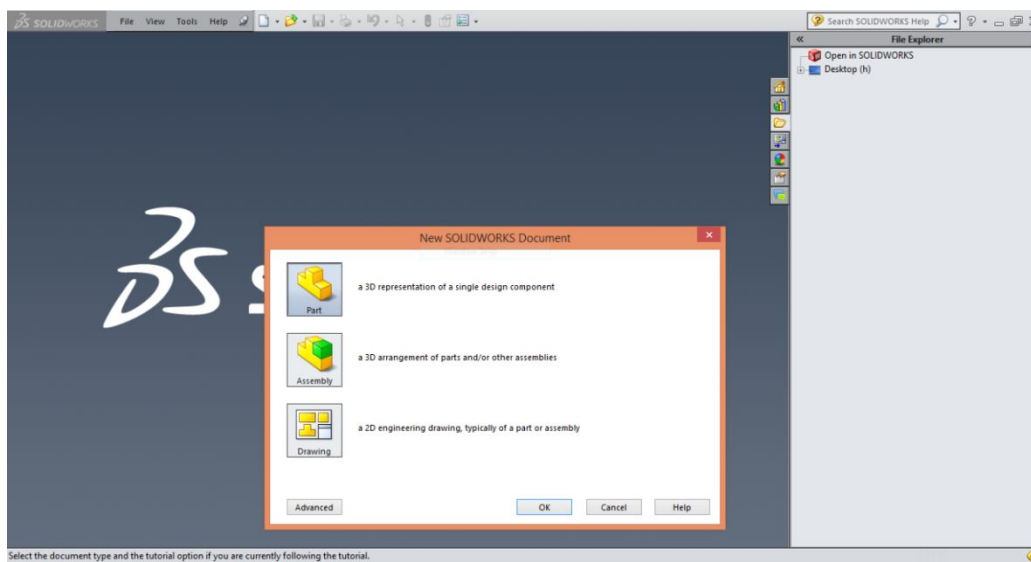

Figure (3-1) the start page of solidworks program

3-5-2 Second step:

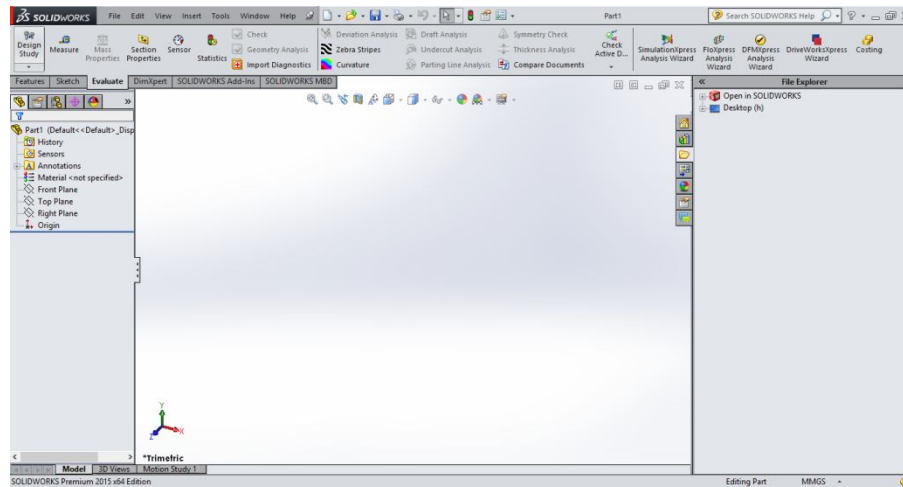

Figure (3-2) Main face of solidworks program

3-5-3 Third step:

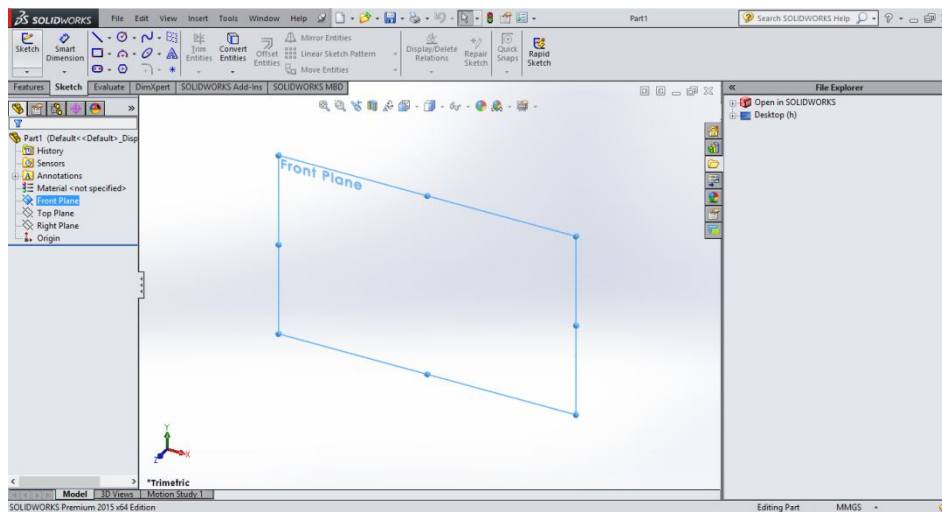

Figure (3-3) Choose suitable plane

3-5-4 Fourth step:

Table (3-1):

Command	Menu
Line	Sketch
Circular	Sketch
Spline	Sketch
Extruded boss	Feature
Revolved	Feature
Flit	Feature
Extruded cut	Feature
Rotate	Modify
Copy	Feature

Commands for solidwork modeling

3-5-5Finaldesign:

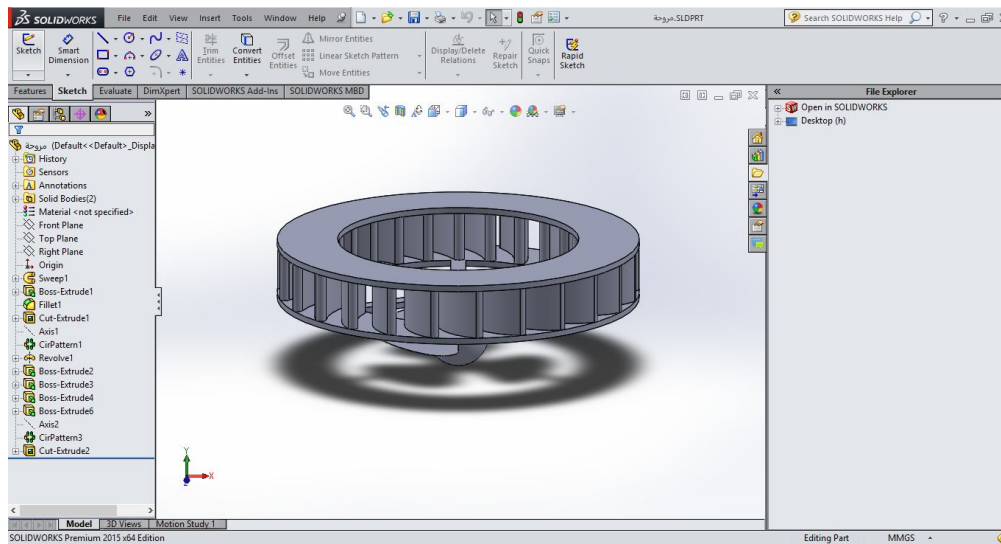

Figure (3-4) Final Design

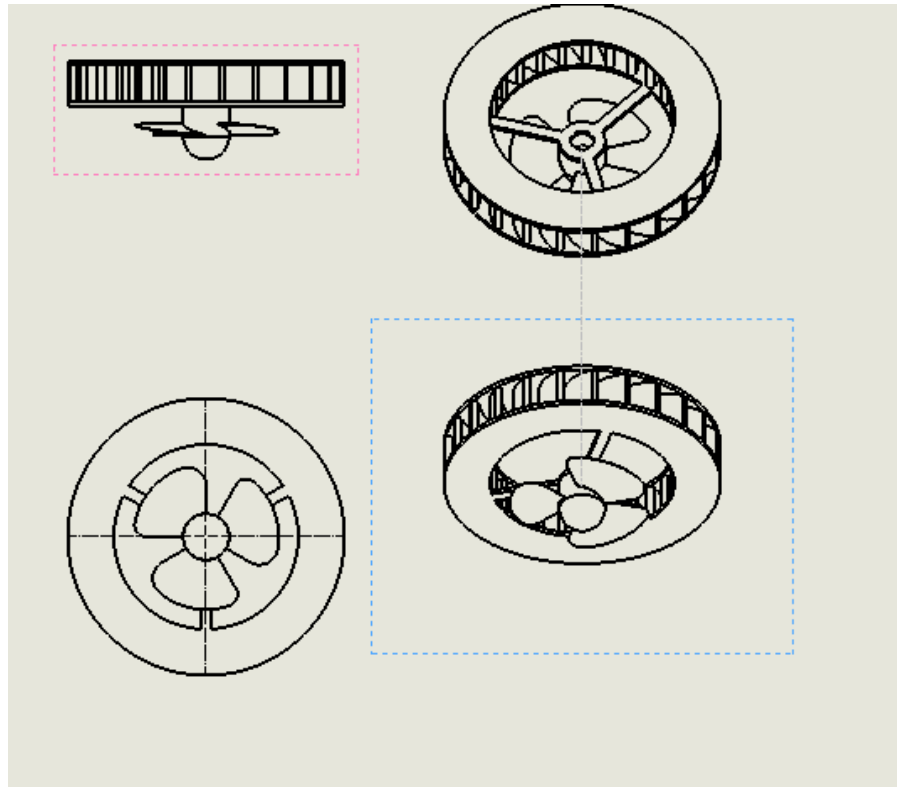

Figure (3-5) Final design of Kaplan model

3-6Calculation:

5-6-1Power:

The power of the runner can be calculated with the following equation:

$$P= Q \cdot H \cdot g \cdot \eta_h \cdot \rho \dots\dots\dots (3-1)$$

Where:

Q discharge [m³/s]

H gross head [m]

η_h Hydraulic efficiency [-]

ρ water density [kg/m³]

g acceleration of gravity [m/s²]

The efficiency depends on the level of the losses which depend on the construction of the water passage of the turbine. The site where the experimental rig of the turbine can be built provides a maximum gross head of 3m. An efficiency of 0.9 can be assumed for a Kaplan turbine.

In addition, the following values are known:

$$\rho = 1000 \text{ kg/m}^3$$

$$g = 9.81 \text{ m/s}^2$$

$$100 \cdot 10^3 = Q \cdot 3 \cdot 1000 \cdot 9.81$$

$$Q = 3.8 \text{ m}^3/\text{s}$$

$$Q = A \cdot V \dots \dots \dots (3-2)$$

$$V = \sqrt{2gh} \dots \dots \dots (3-3)$$

$$A = 3.8 / (2 \cdot 9.81 \cdot 3)^{0.5} = 0.856 \text{ m}^2$$

3-5-2

Speed of the turbine:

The specific speed is a dimensionless parameter and characterizes the hydraulic Properties of a turbine in terms of speed and discharge capacity; it is based on similitude rules.

The specific speed is defined as:

$$NQE = \frac{n \cdot \sqrt{Q}}{E^{3/4}} \dots \dots \dots (3-4)$$

Where:

E specific hydraulic energy of machine [J/kg]

N rotational speed of the turbine [s⁻¹]

The specific hydraulic energy of machine can be established with the following:

Equation:

$$E = H_n * g \dots\dots\dots (3-5)$$

Where:

H_n net head [m]

A net head of 2.7m arises from the product of the gross head and the efficiency:

$$H_n = H * \eta_h \dots\dots\dots (3-6) \quad [m]$$

Due to statistical studies of schemes, F. Schwinger and J. Gregory established the following correlation between the specific speed and the net head for Kaplan turbines:

$$NQE = \frac{2.294}{H_n^{0.486}} \dots\dots\dots (3-7)$$

The net head =

$$H_n = 3 * 0.9 = 2.7 \text{ m}$$

$$E = 2.7 * 9.81 = 26.5 \quad \text{J/kg}$$

Then we find out the specific speed of the Kaplan turbine is:

$$NQE = \frac{2.294}{H_n^{0.486}} = 1.42$$

3.6.3 Rational speed:

We must have rational speed of 1500 rpm getting to the motor that fixed the turbine.

$$N = \frac{NQE * E_4^3}{\sqrt{Q}} = \frac{1.42 * 11.68}{\sqrt{3.8}} = 9.58 \text{ s}^{-1}$$

3-6-4 Runaway speed:

The runaway speed is the maximum speed which the turbine can Theoretically attain; it is achieved during a load rejection. Depending on the Regulation of the Kaplan turbine

$$N_{\max} = n * 3.2 \Rightarrow 3.2 * 9.58 = 30.656$$

3-6-5 Runner diameter:

$$D_e = 84.5(0.79 + 1.602 * NQE) * \frac{\sqrt{H}}{60 * 1000} \dots \dots \dots (3-8)$$

The runner diameter = 0.63 m

3-6-6 the hub diameter:

$$D_i = (.25 + \frac{.0951}{NQE}) * D_e \dots \dots \dots (3-9)$$

The hub diameter = 0.199m

3-5-5 Design of guide wheels:

$$D_{ego} = 60 * K_{ug} * \sqrt{2gh/\pi n} \dots \dots \dots (3-10)$$

$$D_{ego} = 60 * 0.96 * (2 * 9.81 * 3)^{0.5} / 3.14 * 9.58 = 14.69 \text{ m}$$

3-5-6 Blade area:

The blade area was be calculated on solidwork programs as blew:

$$A = 0.067 \text{ m}^2$$

For 3 blades = $3 * 0.067 = 0.2037 \text{ m}^2$

$$F = p/v$$

$$V = 3.14D * N / 60 = 0.5608 \text{ m/s}$$

$$F = 100 * 10^3 / 0.5608 = 178310.7 \text{ N}$$

$$P = F/A = 1749828.482 \text{ Pa}$$

3-5-7 Inlet velocity triangle:

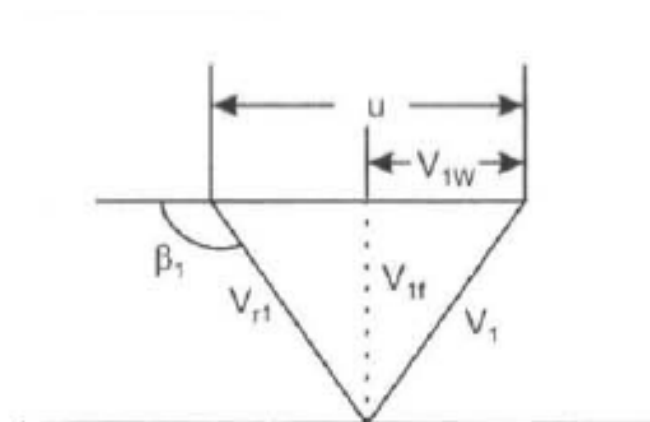

Inlet velocity triangle figure (3-6)

$$V_1 = \text{primary speed} = (2 * 9.81 * 3)^{0.5}$$

$$U = \tan 60 * V_1 = 7.672 * \tan 60 = 13.288 \text{ m/s.}$$

$$V_{1f} = \sin 45 * 13.288 = 9.4 \text{ m/s.}$$

$$V_{1w} = \cos 45 * 13.288 = 9.45 \text{ m/s.}$$

Chapter4

Chapter Four

Result and analysis

After the model have been made using the solidwork and the static analysis withansys software program for the guide vans and blade,and determined the fixed part and the movable parts andthis analysis have been made for three different materials (copper, structural steel and stainless steel) and make compare between them.

4-1The fixed support:

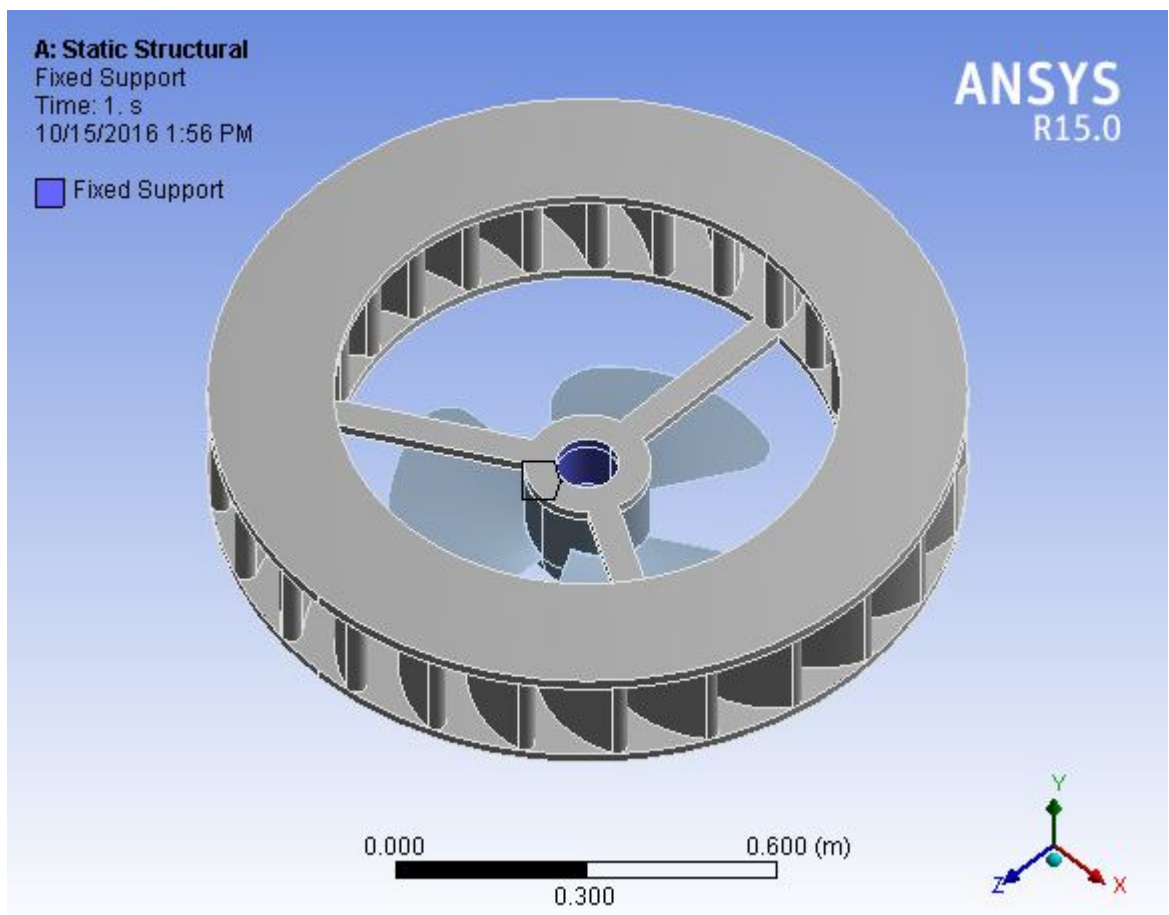
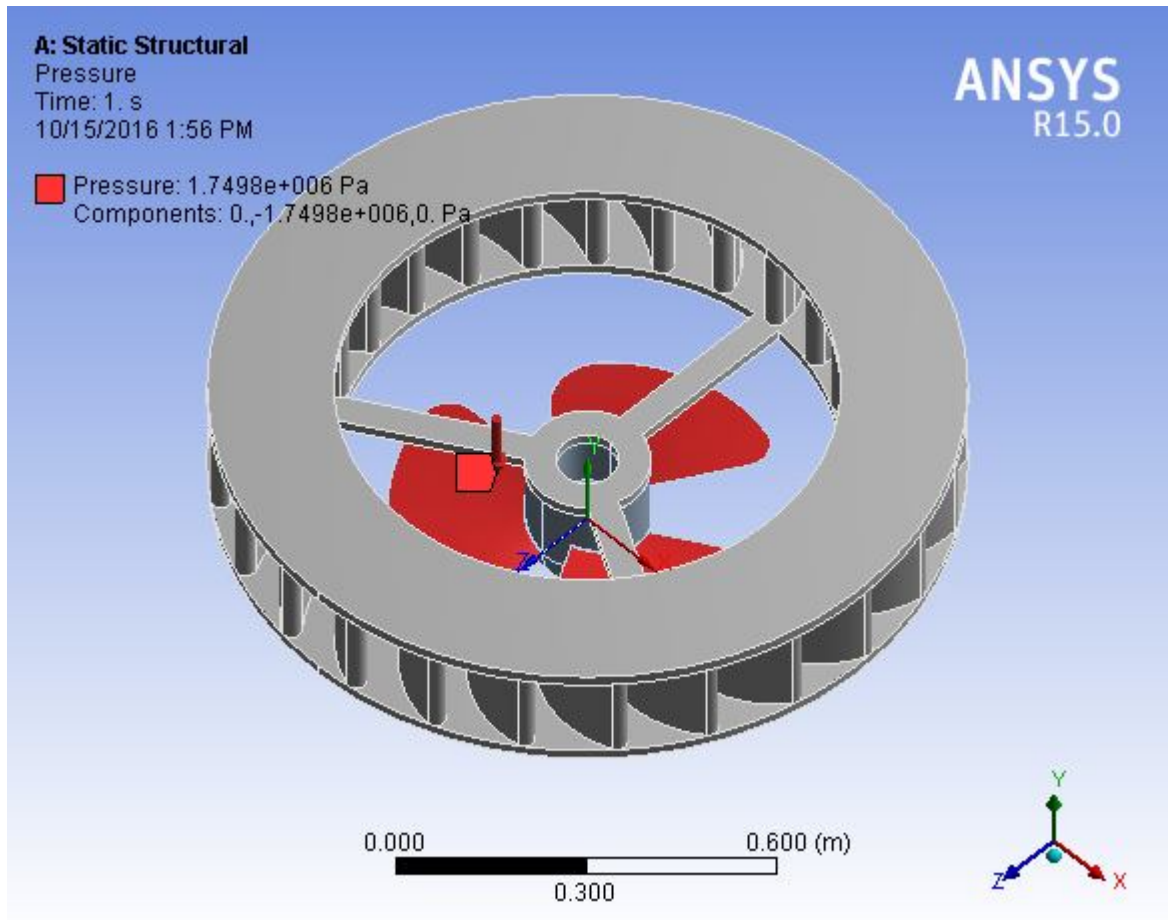

Figure (4-1)Fixed support

The fixed support choosed in this places to fixed blade it moiton

4-2The pressure:



Figure(4-2) The pressure

The pressure contain in blade because the blade had get the force

4-3The Mesh:

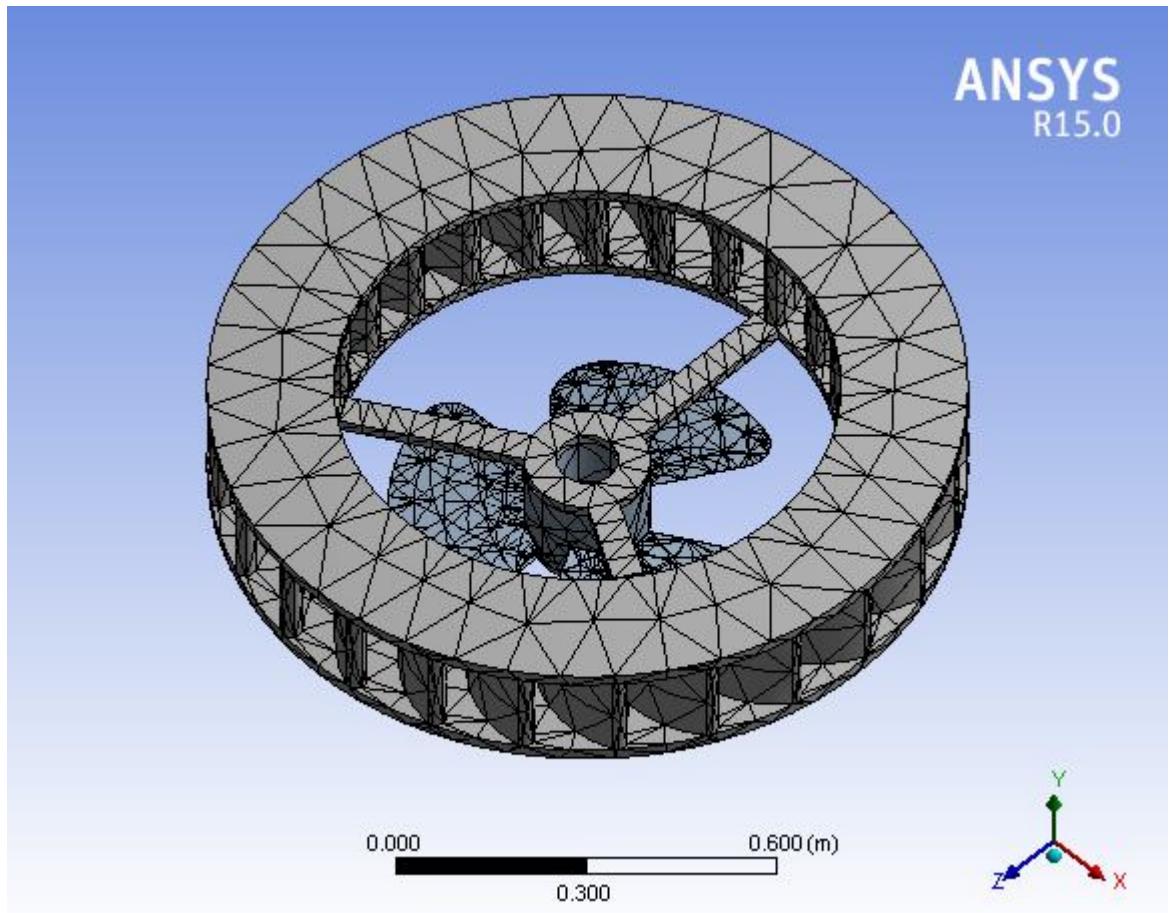

Figure(4-3) the Mesh

The analysis was made to get the maximum and the minimum of:

- 1-The stress.
- 2-The strain.
- 3-The total deformation.

4-4 Copper:

Static analysis have been done using ansys software program for the copper with Yield stress = 70MPa to find out the outcome for

4-4-1 The maximum and the minimum principal elastic strain:

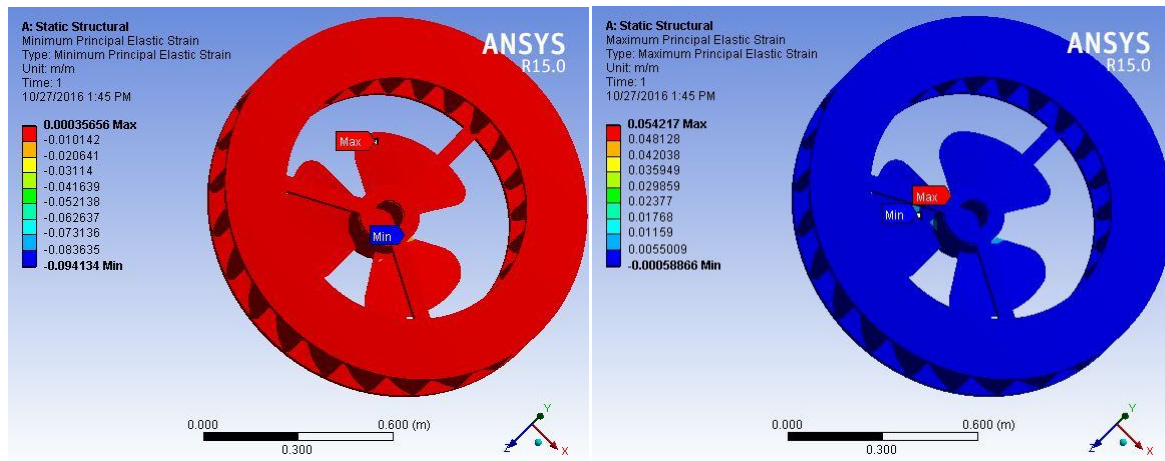

Figure (4-4) show the maximum and minimum strain

Max =0.054217 Pa

Min= -0.09414 Pa

The maximum strain will be in blade because the pressure and force will applied and for other part there will less strain on it. And this force is generating by the water pressure and flow. And the strain is mostly depending on the mechanical physical specification of the material such as (yield stress and maximum stress).

4-4-2 The maximum principal stress:

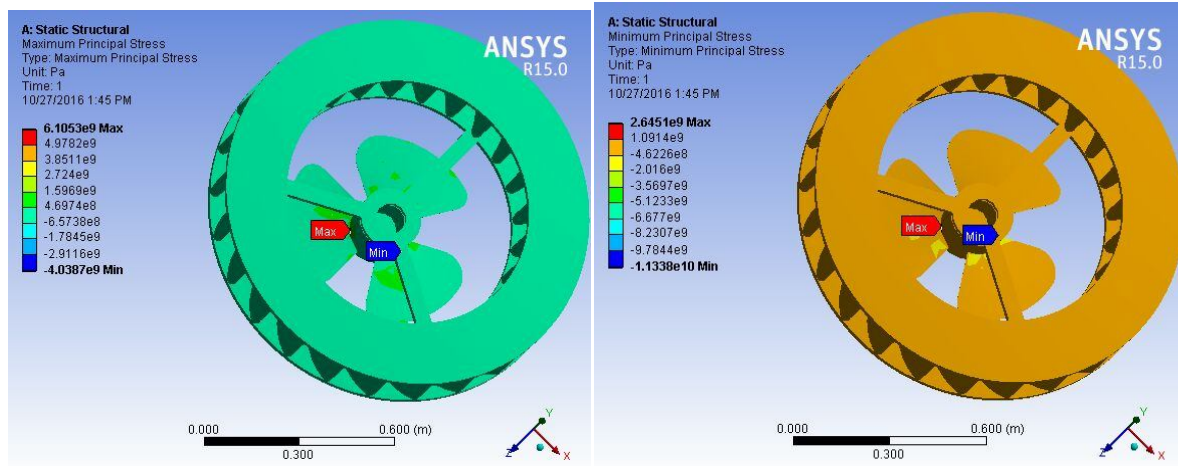

Figure (4-5) show the maximum & minimum principal stress

Max= 6.1053e9 Pa

Min = -1.1338e10Pa

The maximum stress has been found on the blade generally because it have small diameter than the runner vans so the impact of pressure will great on the blade. And the stress also depends on the material density.

4-4-3 Total deformation:

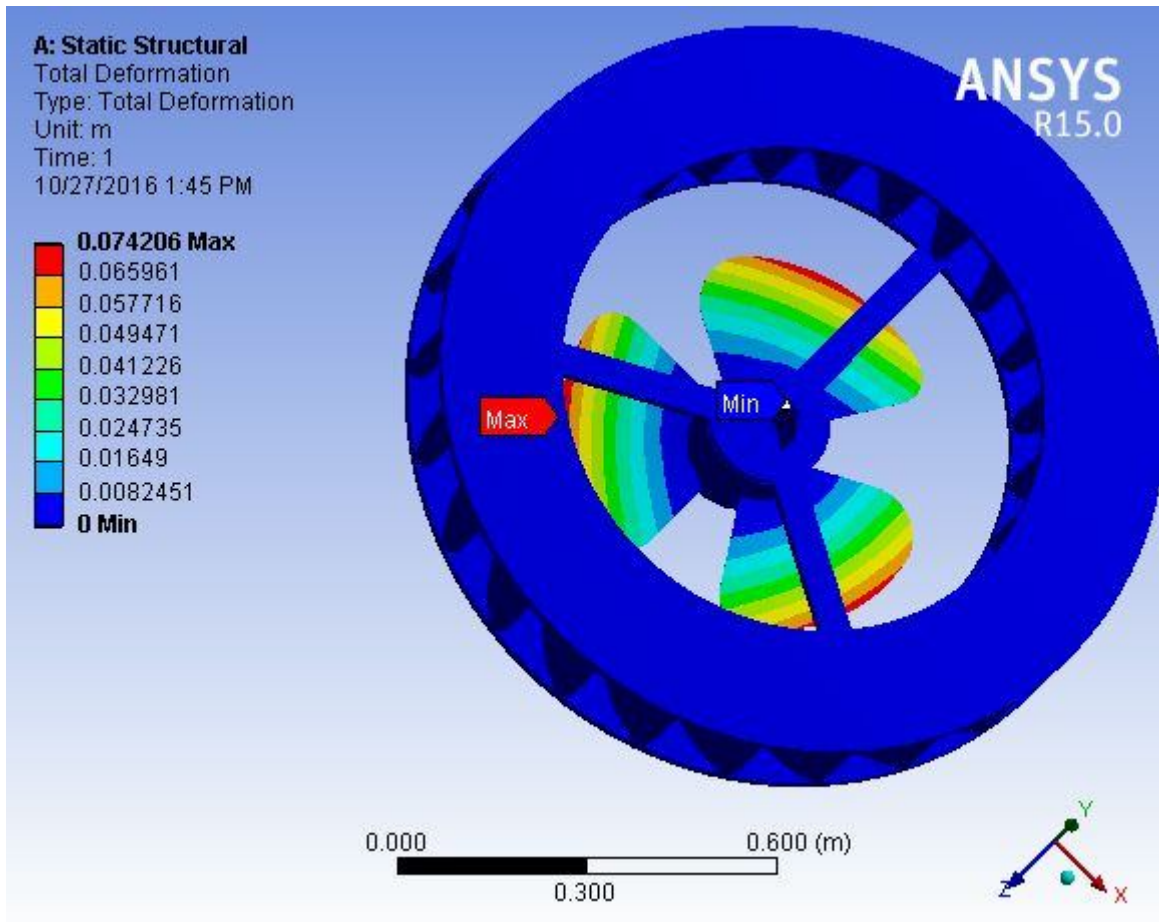

Figure (4-6) the total deformation

Max 0.074206m

Min 0 m

The maximum deformation is in the edge of the blade because the most pressure and motion be effecting on the blade. And the blade is fixed on the hub so the hull deformation will be applied on the edge of the blade and for the guide wheels there will be less deformation because it does not revise a lot of stress.

4-5 Structural steel:

Static analysis have been done using ansys software program for the copper with Yield stress 200MPa

4-5-1 the maximum and the minimum strain:

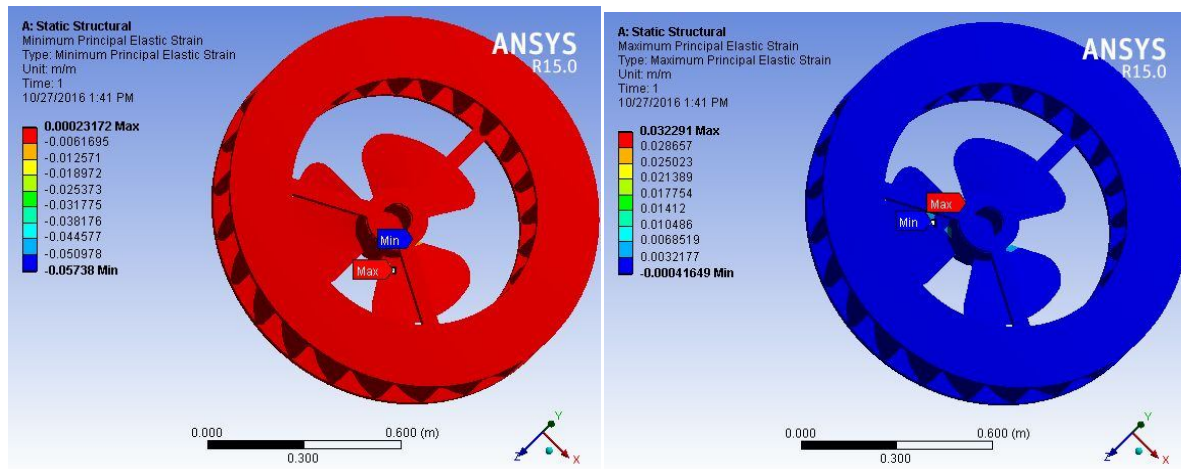

Figure(4-7)the maximum and the minimum strain:

The maximum= 0.032291Pa

The minimim= -0.05738 Pa

The maximum strain will be in blade because the pressure and force will applied and for other part there will less strain on it. And this force is generating by the water pressure and flow.

4-5-2 The maximum and the minimum of the stress:

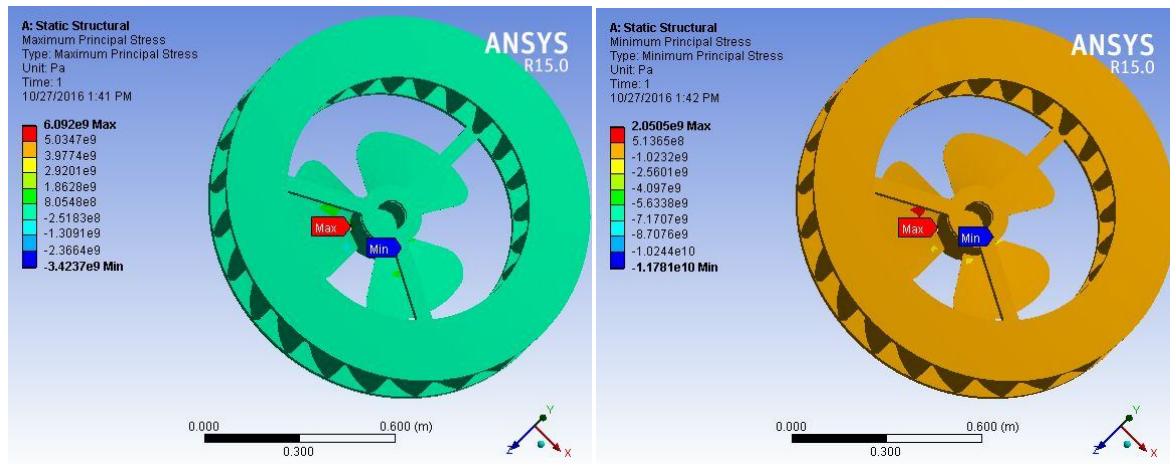

Figure(4-8) The maximum and the minimum of the stress:

The maximum = 6.092×10^9 Pa

The minimum = -1.1781×10^{10} Pa

The maximum stress has been found on the blade generally because it has a small diameter than the runner vanes so the impact of pressure will be great on the blade. And the stress also depends on the material density.

4-5-3 The maximum and minimum stress:

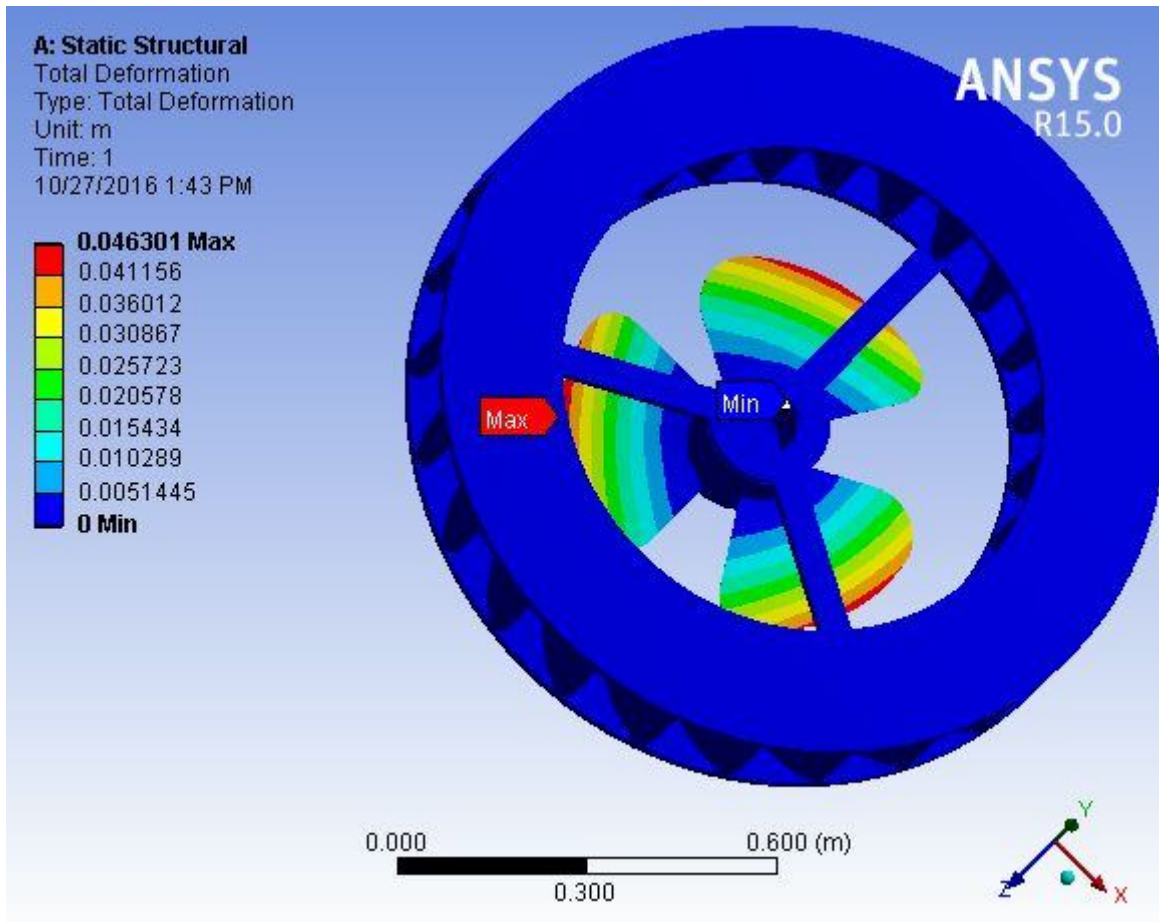

Figure (4-9) The maximum and minimum stress

Max= 0.0458165m

Min =0 m

The maximum deformation is in the edge of the blade because the most pressure and motion be effecting on the blade. And the blade is fixed on the hub so the hull deformation will be applied on the edge of the blade and for the guide wheels there will be less deformation because it does not revise a lot of stress.

4-6 Stainless steel:

Static analysis have been done using ansys software program for the copper with Yield stress 250MPa

4-6-1 The maximum and minimum stress:

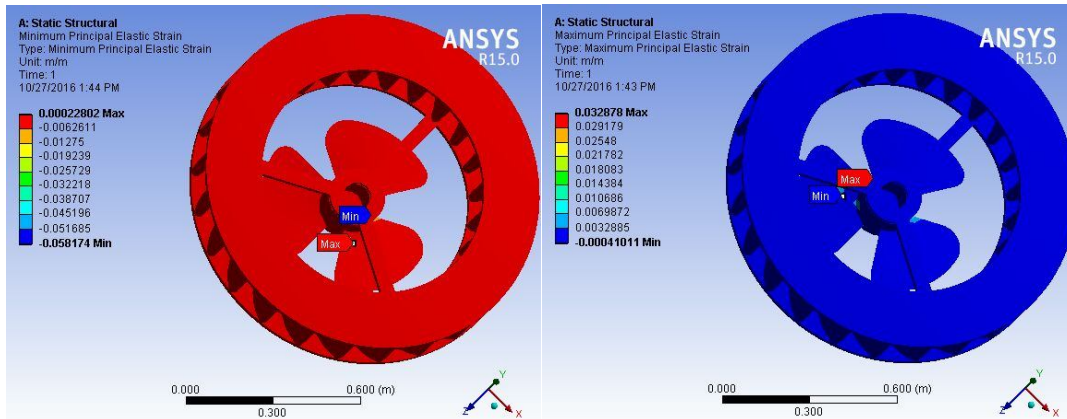

Figure(4-10)The maximum and minimum strain:

The maximum= 0.032878 Pa

The minimum= -0.058174 Pa

The maximum strain will be in blade because the pressure and force will applied and for other part there will less strain on it. And this force is generating by the water pressure and flow.

4-6-2 The maximum and minimum stress:

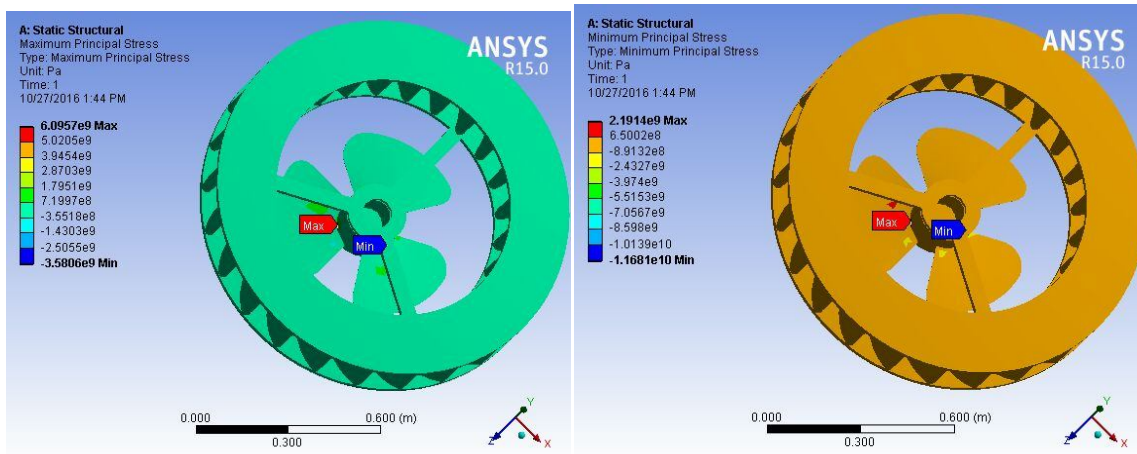

Figure (4-11) The maximum and minimum stress:

The maximum=6.0957e9 Pa

The minimum= -1.1681e10 Pa

The maximum stress has been found on the blade generally because it has a small diameter than the runner vanes so the impact of pressure will be great on the blade. And the stress also depends on the material density

4-6-3 The total deformation:

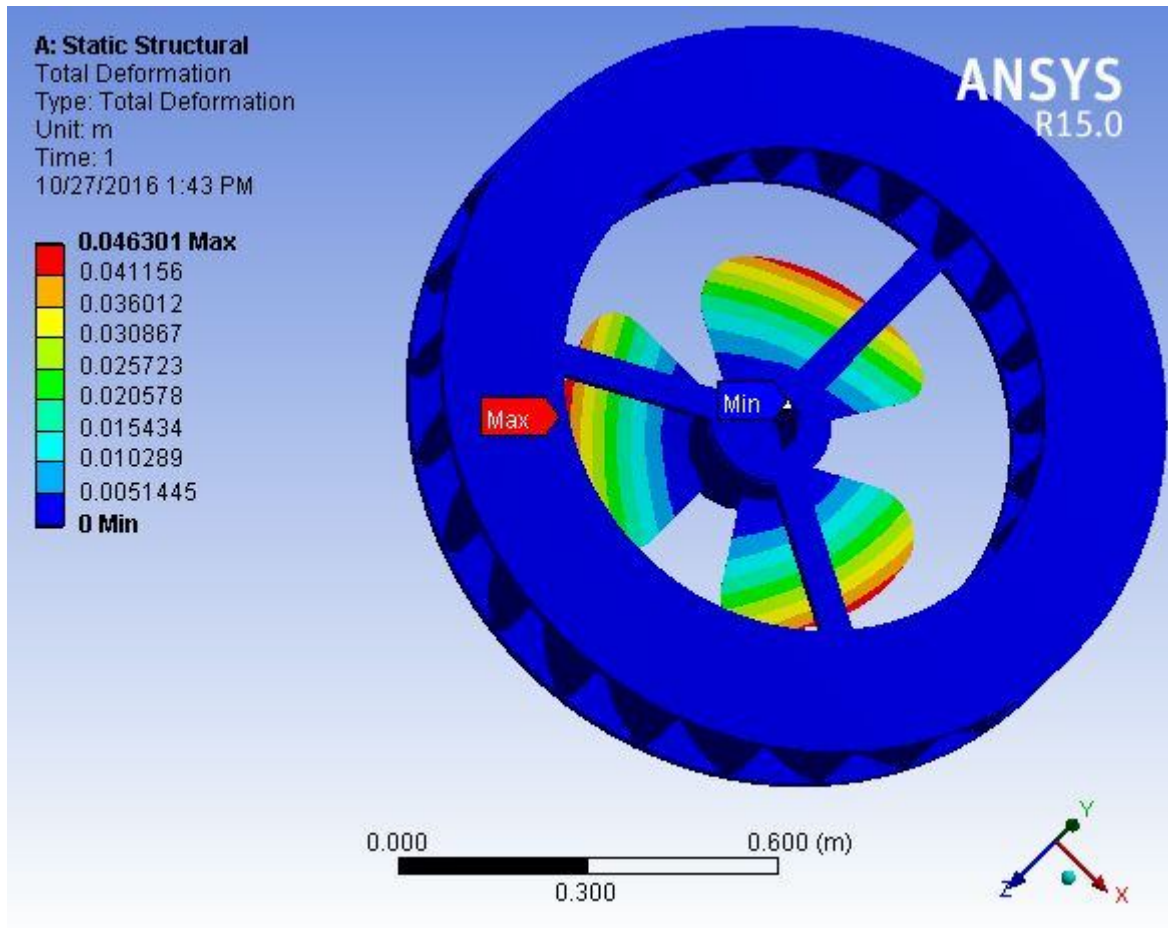

Figure (4-12) show the total deformation

Max = 0.046301m

Min = 0 m

The maximum deformation is in the edge of the blade because the most pressure and motion be effecting on the blade. And the blade is fixed on the hub so the hull deformation will be applied on the edge of the blade and for the guide wheels there will be less deformation because it does not revise a lot of stress

4-7 comparing between chosen materials:

The table (4-1):

	Copper	Structural steel	Stainless steel
Yield stress	70	200	250
Max stress	6.1053e9	6.092e9	6.0957e9
Min stress	-1.1338e10	-1.1781e10	-1.1681e10
Max strain	0.054217	0.032291	0.032878
Min strain	-0.094134	-0.17214	-0.058174
Max Total deformation	0.074206	0.045816	0.046301
Min total deformation	0	0	0

Comparison figures between the three materials

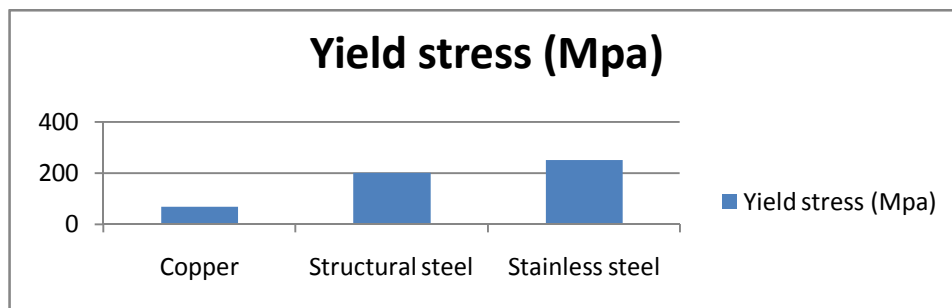
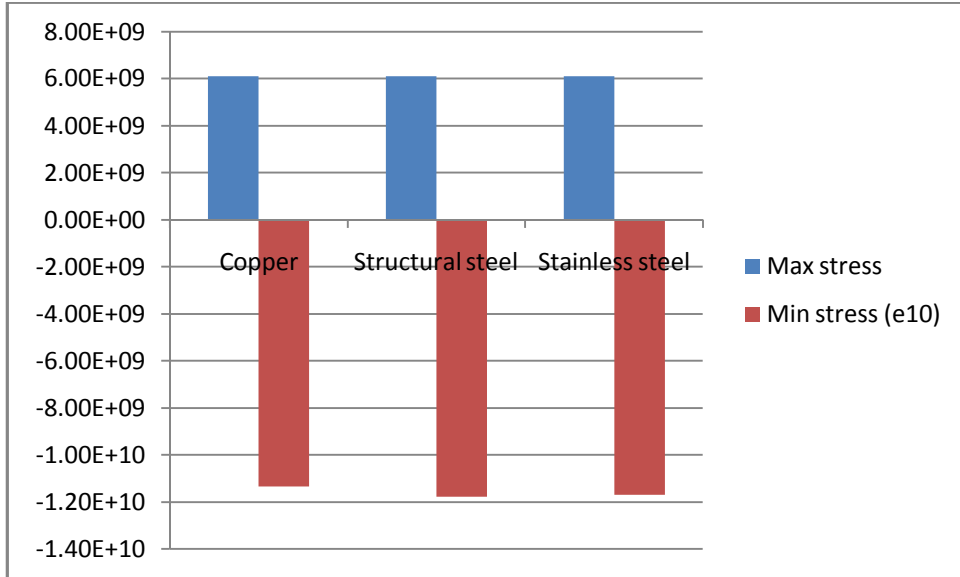
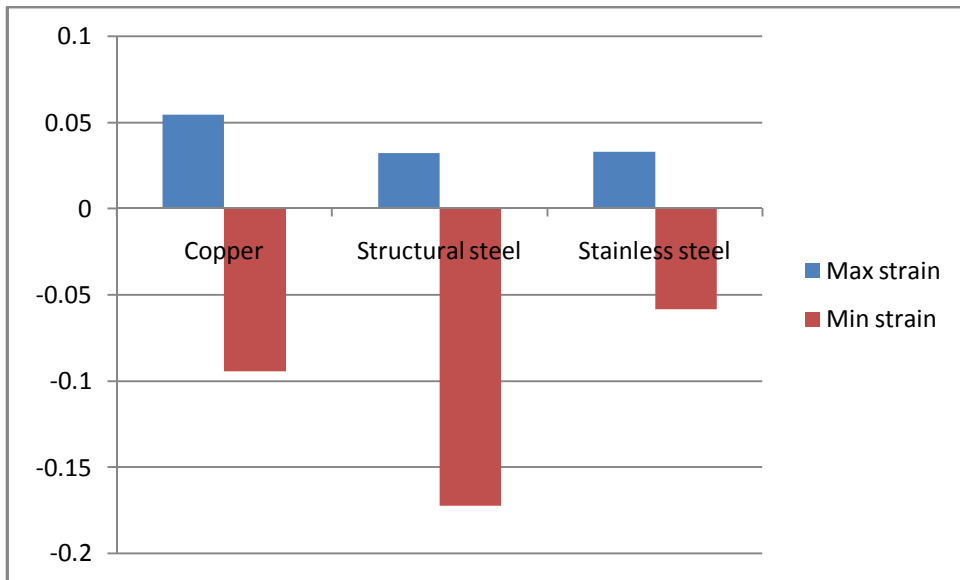

Figure (4-13) yield stress



Figure(4-14) maximum and minimum stress



Figure(4-15) the maximum and minimum strain

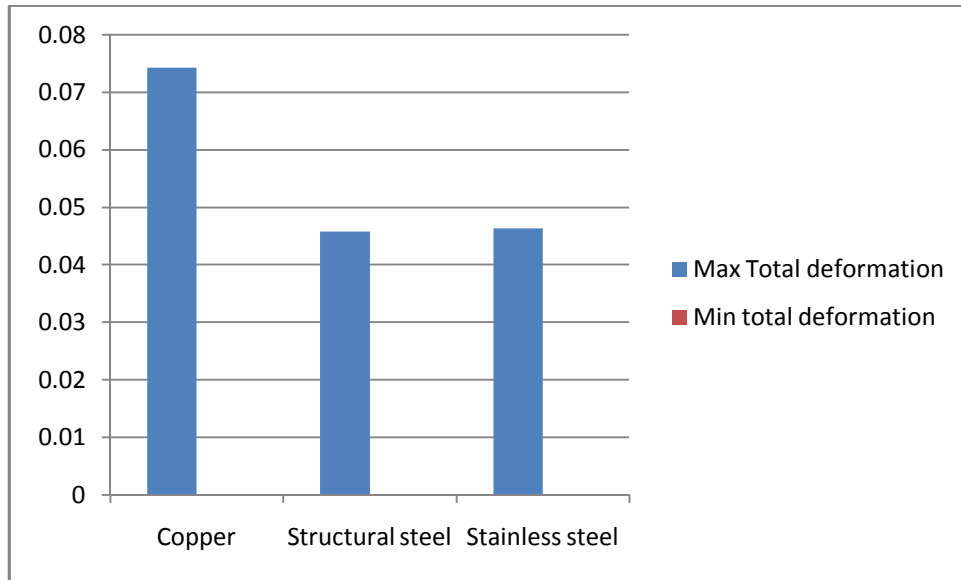

Figure(1-15) the total deformation

Stainless steel was found out its suitable for design because mechanical specification and its high resistance for cavitations and rust.

Chapter 5

Chapter Five

Conclusions & Recommendations:

5.1 Conclusion:

The research concludes that in order to generate 100KW of electric power using Kaplan turbine with water head of 3m and hydraulic efficiency 0.9, The runner diameter is 0.63m and the hub diameter is 0.199m with water flow rate of $3.8\text{m}^3/\text{s}$ and the specific speed of the turbine is 1.42 and running speed is (30.656m/s) and the rational speed of the turbine is 9.58s^{-1} .

1. The turbine consists of 3 blades pinned to the hub, and the total area of the blades is 0.2037m^2 .
2. After the analysis have been done the result for the three material found out be for the copper the maximum stress $6.1053\text{e}9\text{Pa}$ and the minimum stress $-1.1338\text{e}10\text{Pa}$ and the maximum strain 0.054217Pa and the minimum -0.094134Pa and the maximum total deformation 0.074206m .
3. And for the structural steel the maximum and minimum stress $6.092\text{e}10\text{Pa}$ and $-1.1781\text{e}10\text{Pa}$ and the maximum and minimum strain 0.032291Pa and -0.05738Pa the maximum total deformation 0.045616m .
4. And for stainless the maximum and minimum stress $6.0957\text{e}9\text{Pa}$ - $1.1681\text{e}10\text{Pa}$ and the maximum and minimum strain 0.032878Pa and -0.058174Pa and maximum total deformation is 0.046301m .
5. Stainless steel is the most suitable material to make the turbine for its high characteristics resisting rust and cavitation having yield stress of (250MPa) and density of (3300kg/m^3).

5.2 Recommendations:

Kaplan turbine which is the most suitable low head hydraulic turbine for generating electric power in Sudan according to its mechanical characteristics and low head water storage of the dams due to the landscape and contour. Therefore the research recommends that:

- The design should be manufactured and tested.
- The design should be simulated using software programs to find out the dynamic analysis (CFD).
- Making a study on the effect of clay on the turbine and its varying ratios through the years to find out new methods to decrease the effect on the turbine.
- Designing Kaplan turbine with adjustable blades and studying the change and effect on the efficiency.
- A study to replace all the hydroelectric turbines in Sudan for power generation with Kaplan turbines and validate the outcome.
- A study of water levels in the rivers of Sudan throughout the year and see its impact on power generation.

References:

- <http://www.infoplease.com/ipa/A0001336.html>- 17/9/2016
- www.tic.toshiba.com.au/power/product_brochures_and_reference_lists/hydro_turbines.pdf – 9/5/2016
- www.eere.energy.gov/inventions/pdfs/gcktechnologyinc_2_.pdf - 11/8/2015
- files.asme.org/ASMEORG/Communities/History/Landmarks/5599.pdf- 21/2/2016
- Gopalkrishnan, G and Prithviraj, D (2002), “ A Treatise on Turbo machines”
- Scitech Publications (India) Pvt. Ltd, ISBN: 8187328983
- Logan, E Jr, (1993) “Turbo machinery – Basic Theory and Application”
- www.wkv-ag.com/englisch/downloads/WKV-Image10.pdf - 25/9/2016
- TimoFlaspohler, “Design of runner of Kaplan for small hydraulic power plants”. 2007
- Rajput. “Fluid Machines & Hydraulic Machines”.
- “Turbo Machinery”
- “Statistical studies”. Schemes F. Schweigrt&J.George -2005