

# **1 Chapter 1: Introduction**

The terms primary oil recovery, secondary oil recovery, and tertiary (enhanced) oil recovery are traditionally used to describe hydrocarbons recovery according to the method of production or the time at which they are obtained.

## **1.1 Primary Oil Recovery**

(Muskat) defines primary recovery as the production period beginning with the initial field discovery and continuing until the original energy sources for oil expulsion (the natural drive mechanism) are no longer alone able to sustain profitable producing rates. The natural energy responsible for recovering the oil under primary recovery is:

- I. Depletion drive.
- II. Water drive.
- III. Gas cap drive.
- IV. Gravity drainage drive.
- V. Rock and liquid expansion drive.
- VI. Combination drive.

## **1.2 Secondary Oil Recovery**

(James Sheng 2010) Secondary recovery is recovery by injection of external fluids, such as water and/or gas, mainly for the purpose of pressure maintenance and volumetric sweep efficiency.

## **1.3 Enhanced Oil Recovery (EOR) Processes**

Enhanced oil recovery (EOR) processes include all methods that use external sources of energy and/or materials to recover oil that cannot be produced, economically by conventional means.

## **1.4 The Difference between IOR/EOR**

IOR is an acronym for Improved Oil Recovery that is commonly used to describe any process, or combination of processes, that may be applied to economically increase the cumulative volume of oil that is ultimately recovered from the reservoir at an accelerated rate. IOR may include EOR, new well drilling, workover jobs, and production enhancement. (Sunil.k and Abdulaziz. A)

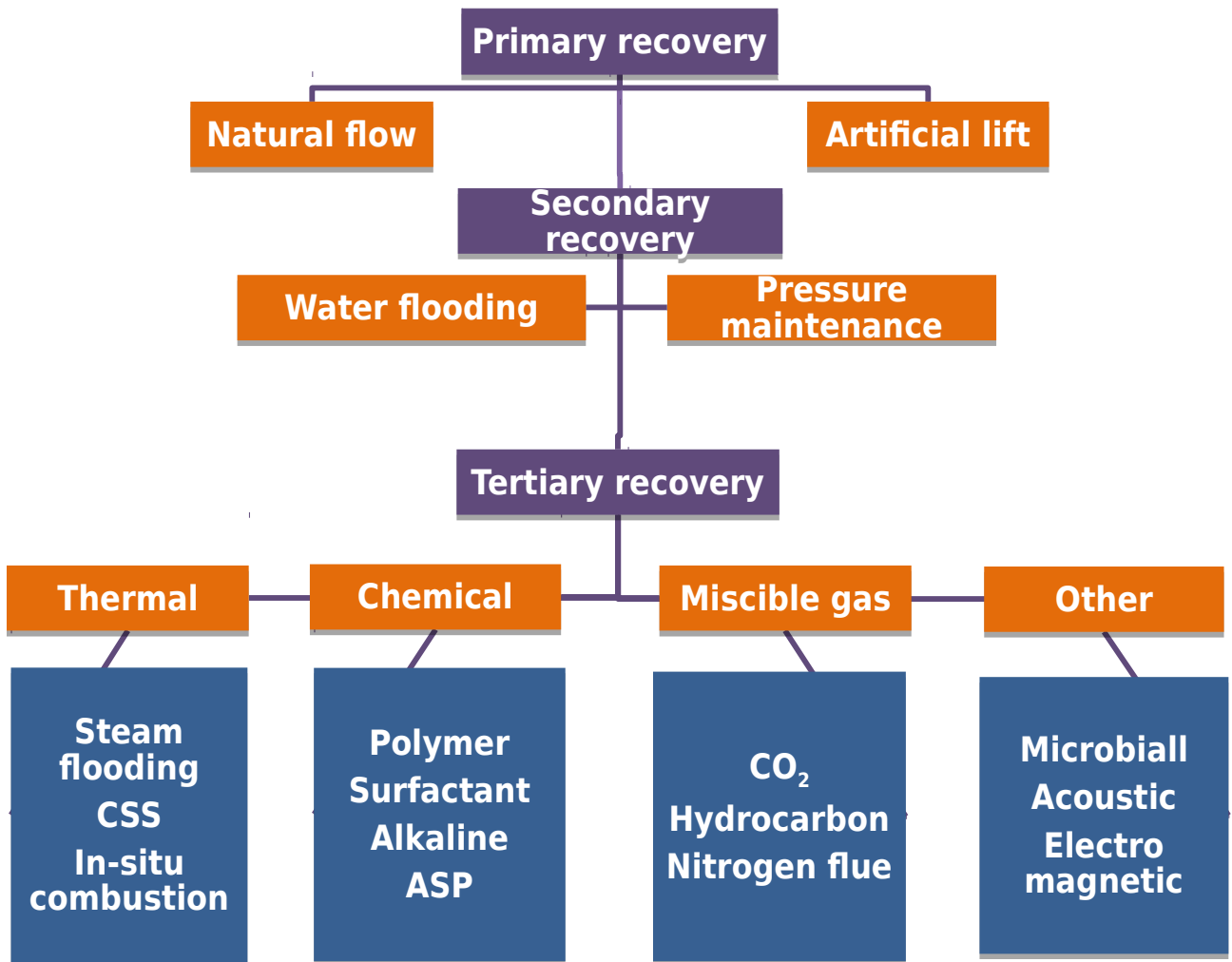

**Figure 1-1: The Recovery Stages**

## 1.5 Problem statement

In Bamboo oil field, after waterflooding a part of the remaining oil (residual oil saturation) is still trapped in the porous media due to the capillary forces, the use of surfactant can lower interfacial tension and hence decrease the capillary forces, allowing the oil to move towards the producer.

## **1.6 Objectives**

### **General objectives:**

- Study the possibility of surfactant flooding as good EOR method for Bamboo main oil field based on screening criteria and simulation results.
- Build a model that resembles the actual bamboo main field conditions, based on the available fluid and rock properties.

### **Specific objectives:**

- Design optimum surfactant concentration.
- Design optimum injection rate for bamboo main oil field.

## **Introduction to the Case Study**

Greater Bamboo Field is located in block 2A Muglad Basin consist of four structures, Bamboo west, main, east and south and covers an area of about 144 km as shown in figures (1-2). It involves of multi-layered under-saturated sandstone reservoir of late cretaceous ages buried at depth ranging from 1000 m to 1500 m. The total field STOIPP and Recovery Factor (RF) is currently estimated at around 509 MMSTB, 16% respectively. To date the field had recovered more than 69% of the Ultimate Recovery (EUR).



**Figure 1-2: location of bamboo field**

The field initially produced around 20,000 STB/D with early water breakthrough and very minimal gas production rate until today. However, the production rate declined rapidly when the water production rate increased. Major factors that contributed to this problem are possibly due to the fingering and water conning. Currently the field is producing around 9000 STB/D with water cut around 75% and keeps increasing (Elamin S.Mohammed & Husham A.Ali, 2014).

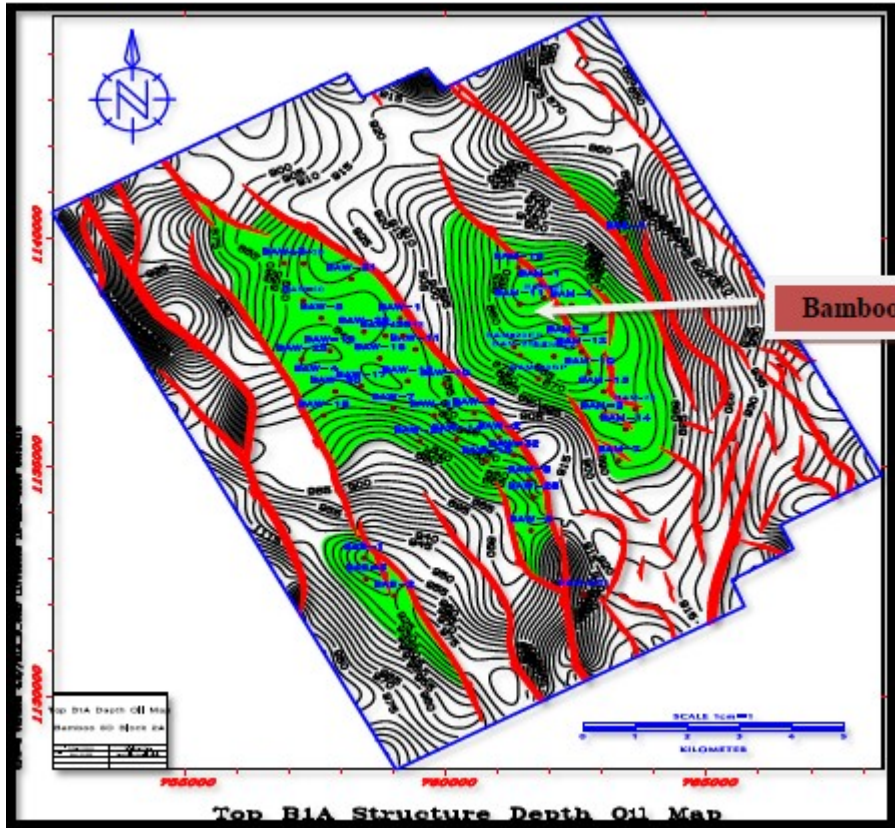

**Figure 1-3: Bamboo field geological contour map.**

**Thesis outlines:**

In this thesis chapter one contains a general introduction into EOR, problem statement, the objectives of study, and introduction to case study. Chapter two discuss the theoretical background and the important concepts related to surfactant flooding, and literature review. In chapter three the methodology of the project is explained, the screening criteria and the necessary steps to reach the results on the reservoir simulation software CMG. Chapter four the results are discussed and displayed in forms of figures and graphs. Chapter five includes the conclusions and recommendations.

## **2 Chapter 2: Literature Review & Background**

### **2.1 General Background**

#### **2.1.1 Introduction**

Oil production in many fields has reached the mark of residual oil saturation. This in turn has forced the oil industry to recover oil from more complicated areas, where the oil is less accessible, by means of advanced recovery techniques. The reserves and production ratios in sandstone fields have around 20 years of production time left. The proven and probable reserves in carbonate fields have around 80 years of production time left (Montaron, 2008). With global energy demand and consumption forecast to grow rapidly during the next 20 years, a more realistic solution to meet this need lies in sustaining production from existing fields by means of EOR (James Sheng2010).

After primary and secondary methods, two-thirds of the original oil in place (OOIP) in a reservoir is not produced and still pending for recovery by efficient enhanced oil recovery (EOR) methods. EOR methods can be categorized into three main processes such as thermal oil recovery, miscible flooding, and chemical flooding (Taber et al. 1979; Shandrygin and Lutfullin 2008).

**2.1.2 When to start EOR (Tarek ahmed, 2001):**

A common procedure for determining the optimum time to start EOR process after water flooding depends on:

- i. Anticipated oil recovery.
- ii. Fluid production rates.
- iii. Monetary investment.
- iv. Costs of water treatment and pumping equipment.
- v. Costs of maintenance and operation of the water installation facilities.
- vi. Costs of drilling new injection wells or converting existing production wells into injectors.

➤ **Basic concepts:**

**1. Interfacial tension :**

The surface tension is defined as the force exerted on the boundary layer between a liquid phase and a vapor phase per unit length. This force is caused by differences between the molecular forces in the vapor phase and those in the liquid phase, and also by the imbalance of these forces at the interface. The surface can be measured in the laboratory and is unusually expressed in dynes per centimeter (Tarek ahmed, 2010).

$$\sigma_{ow} = \frac{r h g (\rho_w - \rho_o)}{2 \cos \theta} \dots\dots\dots (STYLEREF 1 2 SEQ Equation 1)$$

Where:

**r** = pore radius cm

**h** = hight cm

$\rho_o$  = density of oil, gm/cm.



$\rho_w$  = density of water, gm/cm.

$\sigma_{ow}$  = interfacial tension between the oil and the water, dynes/cm.

## 2. Wettability:

Wettability is the preference of one fluid to spread on or adhere to a solid surface in the presence of other immiscible fluids (Craig, 1971).

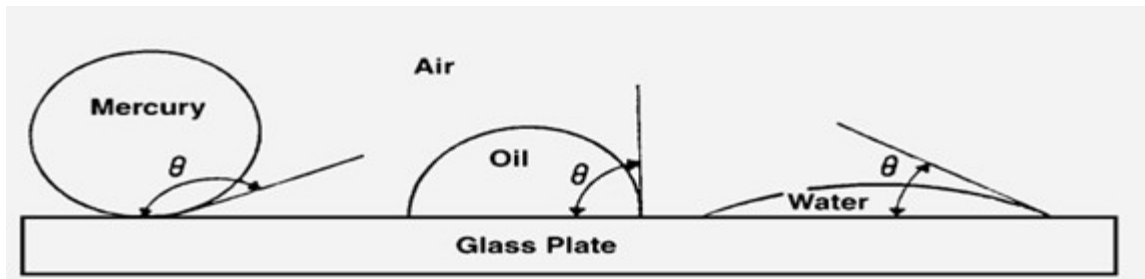

**Figure 2-4: illustration of wettability**

Wettability depends on the mineral ingredients of the rock, the composition of the oil and water, the initial water saturation, and the temperature.

The wettability of reservoir rocks to the fluids is important in that the distribution of the fluids in the porous media is a function of wettability.

Because of the attractive forces, the wetting phase tends to occupy the smaller pores of the rock and the nonwetting phase occupies the more open channels (Tarek ahmed, 2010).

Wettability can be quantified by measuring the contact angle of oil and water on silica or calcite surface or by measuring the characteristics of core plugs with either an Amott imbibition test or a USBM test.

### 3. Capillary pressure

Capillary pressure is the most basic rock-fluid characteristic in multiphase flows. It is defined as the difference between the pressures in the non-wetting and wetting phases (Shunhua Liu, 2007).

$$P_c = P_{nw} - P_w$$

The capillary forces in a petroleum reservoir are the result of the combined effect of the surface and interfacial tensions of the rock and fluids, the pore size and geometry, and the wetting characteristics of the system.

The displacement of one fluid by another in the pores of a porous medium is either aided or opposed by the surface forces of capillary pressure (Tarek ahmed, 2010).

$$p_c = \frac{2\sigma \cos\theta}{R} \dots\dots\dots (STYLEREF 1 2_{STYLEREF 1 2 SEQ Equation 2})$$

Where:

$P_c$  : Capillary pressure.

$P_{nw}$ : pressure in the nonwetting phase.

$P_w$ : pressure in the wetting phase.

$\sigma$  : Interfacial tension between two fluid phases.

$\theta$  : Contact angle, measured in wetting phase.

$R$ : radius of the tube.

### 3. Mobility ratio:

Tarek Ahmed (2000) states that The mobility is defined as the ratio of the permeability to the viscosity and the Mobility ratio (M) is defined as the mobility of displacing phase to mobility of displaced phase, and can be given by:

$$M = \frac{\lambda_{displacing}}{\lambda_{displaced}} \dots\dots\dots (STYLEREf 1 2 SEQ Equation 3)$$

$$M = \frac{\frac{K_{rw}}{K_{ro}} * \mu_o}{\mu_w} \dots\dots\dots (2-1)$$

Where:

**K<sub>ro</sub>, K<sub>rw</sub>** = relative permeability to oil and water, respectively.

**μ<sub>o</sub>, μ<sub>w</sub>** = viscosity of oil and water, respectively.

If a mobility ratio greater than unity, it is called an unfavorable ratio because the Invading fluid will tend to bypass the displaced fluid. It is called favorable if less than unity and called unit mobility ratio when equal to unity.

### 4. Capillary Number

Capillary Number is defined as the ratio of the viscous forces and local capillary forces. This can be calculated from the formula in equation below (Moore and Slobod 1955):

$$N_c = \frac{u \mu_w}{\sigma \cos \phi} \dots\dots\dots (2-2)$$

$u$  = Effective flow rate

$\mu$  = Viscosity of displacing fluid

$\sigma$  = Interfacial Tension

$\theta$  = Contact angle measured through the fluid with highest density.

An increase in capillary number implies a decrease in residual oil saturation and thus an increase in oil recovery.

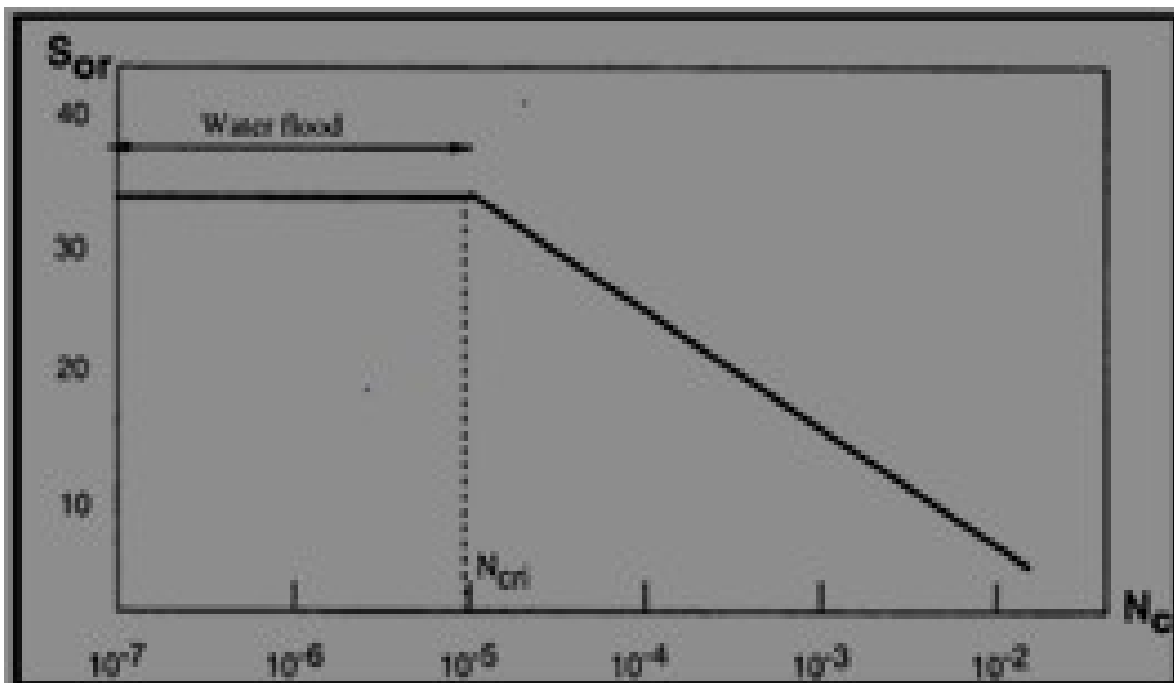

Capillary Desaturation Curve which relates the capillary Number  $N_c$  to the residual oil saturation.

In order to achieve an increase in the capillary number, an increase in the viscosity of the displacement fluid or an increase in the velocity of displacement may not be effective on a field scale. However, a high  $N_c$  can be achieved by reducing the interfacial tension between water and oil by the use of surfactant.

Also as can be seen from the capillary pressure relationship.

$$p_c = \frac{2\gamma \cos \theta}{r}$$

*Equation 6*

A very low oil-water interfacial tension reduces the capillary pressure and thus facilitates oil mobilization allowing water to displace additional oil.

The residual oil can even be reduced to zero if the interfacial tension can be successfully reduced to a zero-value.

## 5. Phase behavior

The phase behavior of surfactant/oil/water mixtures is the single most critical factor determining the success of a chemical flood. The desired ultralow IFT in surfactant systems is usually measured by examining the phase behavior of the microemulsion system, where the regions with high solubilization are located.

Phase behavior is dependent on the type and concentration of surfactant, and brine.

Other important parameters are the effect of high temperature and pressure on the microemulsion properties (at typical reservoir conditions). Predictive models, such as

equations of state, cannot describe the phase behavior of surfactant systems adequately, due to the presence of both surfactants and salts, which are not, included in the available prediction tools. Therefore phase behavior of a particular system has to be measured experimentally.

## 6. Recovery factor

The overall recovery factor (efficiency) RF of any secondary or tertiary oil recovery method is the product of a combination of three individual efficiency factors as given by the following generalized expression:

$$RF = E_D E_A E_V$$

Where **RF** = overall recovery factor

**ED** = displacement efficiency

**EA** = areal sweep efficiency

**EV** = vertical sweep efficiency

## 6. Displacement efficiency ED

Displacement efficiency is the fraction of movable oil that has been recovered from the swept zone at any given time or pore volume injected (Tarek Ahmed, 2010). Mathematically, the displacement efficiency is expressed as:

$$E_D = \frac{\text{Volume of oil at start of flood} - \text{Remaining oil volume}}{\text{Volume of oil at start of flood}}$$

$$E_D = \frac{(\text{pore volume})\left(\frac{S_{oi}}{B_{oi}}\right) - (\text{pore volume})\left(\frac{\hat{S}_o}{B_o}\right)}{(\text{pore volume})\left(\frac{S_{oi}}{B_{oi}}\right)}$$

$$E_D = \frac{\hat{S}_w - S_{wi}}{1 - S_{wi}}$$

$S_{oi}$  = initial oil saturation at start of flood

$B_{oi}$  = oil FVF at start of flood, bbl/STB

$S_w$  DASH = average water saturation in the swept area

$S_{wi}$  = initial water saturation at the start of the flood.

Because an immiscible gas injection or waterflood will always leave behind some residual oil,  $E_D$  will always be less than 1.

## 7. Areal sweep efficiency $E_A$

Is the fractional area of the pattern that is swept by the displacing fluid (Tarek Ahmed, 2000).

### **8. Vertical sweep efficiency $E_v$**

Is the fraction of the vertical section of the pay zone that is contacted by injected fluids (Tarek Ahmed, 2000). The vertical sweep efficiency is primarily a function of:

### **9. Volumetric Sweep Efficiency**

Note that the product of EA  $E_v$  is called the volumetric sweep efficiency. and represents the overall fraction of the flood pattern that is contacted by the injected fluid (Tarek Ahmed, 2000).

### **9. Screening Criteria:**

A large number of variables are associated with a given oil reservoir for instance, pressure, temperature, crude oil type and viscosity and the nature of the rock matrix and connate water.

Because of these variables not every type of EOR process can be applied to every reservoir. An initial screening procedure would quickly eliminate some EOR processes from consideration in particular reservoir application.

➤ **Factors used in the screening are:**

- Reservoir conditions - temperature and pressure.
- Reservoir fluid properties – oil viscosity and density and formation water salinity.
- Reservoir geology – rock type and depth and permeability and porosity. (Teknika , 2000).



Screening data	Unit	Screening criteria					
		Gas	Chemical			Thermal	
		Nitrogen	Polymer	SP	ASP	CSS	SAGD
API	°	35-48	20-40	20-35	20-35	10-34	10-25
WaterCut	%	-	-	-	-	<50	<40
Reservoir viscosity	cp	0.2-0.4	<150	<35	<35	<500000	<500000
Depth	m	>1800	-	-	-	150-1600	150-1000
Net Pay	m	Thin Unless Dipping	-	-	-	>10	>15
NTG	fraction	-	-	-	-	>0.4	>0.4
temperature	°C	-	<90	<90	<90	-	-
permeability(air)	md	-	>50	>50	>50	-	-
Reservoir Pressure	psi	Preferably higher pressure for potential miscibility with oil unless dipping	-	-	-	<1450	<1450
salinity	mg/L	-	<30000	<30000	<30000	-	-
VDP	fraction	0.6-1	0.6-1	0.6-1	0.6-1	0.6-1	0.6-1
Acid number	mgKOH/g	-	<0.1	<0.1	>0.1	-	-

**Table 2-1: screening criteria (Green and Willhite).**

### 2.1.3 Methods of EOR

The EOR methods work under the following principles (Latil et al., 1980):

- Improve sweep efficiency by reducing the mobility ratio between injected and in-place fluids.
- Eliminate or reduce the capillary and interfacial forces and thus improve displacement efficiency.
- Act on both phenomena simultaneously.

#### 2.1.3.1 Miscible Displacement

Miscible oil displacement is the displacement of oil by fluids with which it mixes in all proportions without the presence of an interface, all mixtures remaining single phase.

This is possible only by injecting a miscible agent which reduces the retaining forces to zero is nearly total displacement possible in the pores contacted by miscible agent. Example of fluids injected to achieve miscible displacement (CO<sub>2</sub>, hydrocarbon solvents, nitrogen and H<sub>2</sub>).

### **2.1.3.2 Thermal Methods**

Thermal methods have been used since 1950s, primary and secondary production from reservoirs containing heavy, low gravity oil is usually a small fraction of the initial oil in place. This is due to the fact that these types of oils are very thick and viscous and as a result does not migrate readily to producing wells. If the temperature of crude oil in reservoir can be raised by 100 -200 F over the normal reservoir temperature, the oil viscosity will be reduced significantly and will flow much more easily to a producing well. The temperature of a reservoir can be raised by injecting a hot fluid or by generating thermal energy in-situ by combusting the oil (Ronald E, 2001).

➤ **Thermal Processes Include:**

- I. Steam injection
- II. Cyclic steam stimulation (CSS)
- III. In-situ combustion (ISC)
- IV. Steam assisted gravity drainage (SAGD)

### **2.1.3.3 Chemical Methods**

Chemical flooding methods are considered as a special branch of EOR processes to produce residual oil after water flooding.

In chemical EOR or chemical flooding, the primary goal is to recover more oil by either one or a combination of the following processes (Teknika, 2001):

- Mobility control by adding polymers to reduce the mobility of the injected water, and to increase sweep efficiency.
- Interfacial tension (IFT) reduction by using surfactants, and/or alkalis, to improve the displacement efficiency.

### **I. Polymer Flooding**

Polymer flooding is the process of adding small amount of polymers to thickening brine water to reduce water mobility. In which a large macromolecule is used to increase the displacing fluid viscosity, this leads to improve sweep efficiency in the reservoir.

#### **➤ There two main types of polymers:**

##### **1. XC-biopolymer:**

It is a natural polysaccharide produced by microbial fermentation process. This type reduces mobility ratio by increasing water viscosity. It increases mobility ratio by decreases water viscosity

##### **2. Polyacrylamides:**

They are synthetic chemical products which reduce water mobility by reducing formation permeability to water. (Aurel carcoana,1992).

#### **➤ Polymer Flooding Processes:**

Firstly low salinity brine (freshwater) slug is injected to the reservoir followed by injection of a slug of 0.3 or higher PV of polymer solution. The polymer slug is followed by another freshwater and then followed by continuous drive water injection.

Polymers are usually added to water in concentrations ranging from 250 – 2000 parts per million (ppm).

➤ **Limitations(Aurel carcoana, 1992):**

- a. High oil viscosity requires higher polymer concentration.
- b. Results can be better if polymer flood is started before the water oil ratio become excessively high.
- c. Clays increase polymer adsorption.
- d. Some heterogeneity is acceptable but the extensive fractures must be avoided.

## **II. Alkaline Flooding**

The alkaline flooding method relies on a chemical reaction between chemicals such as sodium carbonate and sodium hydroxide (most common alkali agents) and organic acids (saponifiable components) in crude oil to produce in situ surfactants (soaps) that can lower interfacial tension. Another very important mechanism is emulsification. The addition of the alkali increases pH and lowers the surfactant adsorption so that very low surfactant concentrations can be used to reduce cost (James Sheng, 2010).

Alkaline substances that have been used include “sodium hydroxide, sodium orthosilicate, sodium metasilicate, sodium carbonate, ammonia ammonium hydroxide”.The most popular one is sodium hydroxide. Sodium orthosilicate has some advantages in brines with high divalent ion content (Ronald E, 2001).

## **III. Surfactant Flooding:**

The term surfactant is a blend of surface acting agents. Surfactants are usually organic compounds that are amphiphilic, meaning they are composed of a hydrocarbon chain

(hydrophobic group, the “tail”) and a polar hydrophilic group (the “head”). Therefore, they are soluble in both organic solvents and water. They adsorb on or concentrate at a surface or fluid/fluid interface to alter the surface properties significantly; in particular, they reduce surface tension or interfacial tension (IFT).

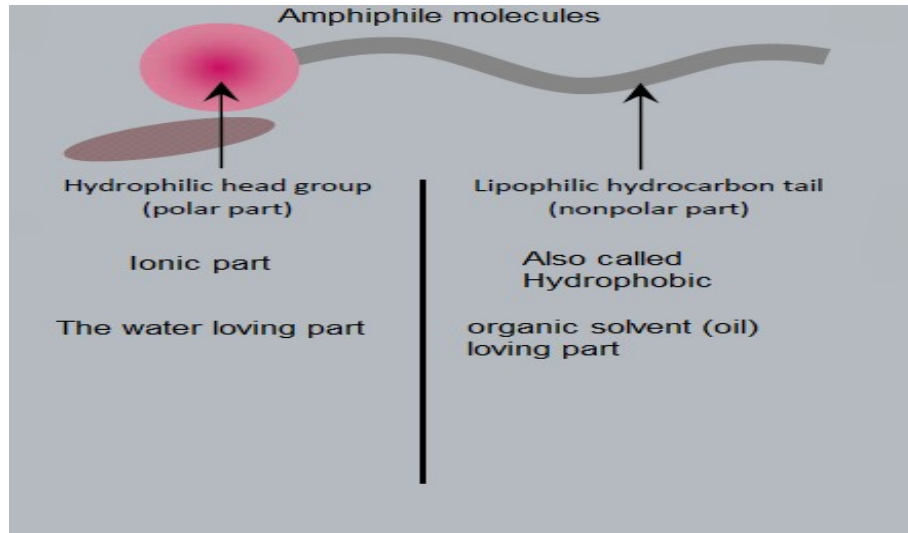

**Figure 2-5: surfactant structure**

In EOR with surfactant flooding the hydrophilic head interacts with water molecules and the hydrophobic tail interacts with the residual oil. Thus, surfactants can form water-in-oil or oil-in-water emulsions. Surfactant molecules are amphiphilic, as they have both hydrophilic and hydrophobic moieties. Amphiphiles adsorb effectively to interfaces and typically contribute to significant reductions of the interfacial energy, [Pashley and Karaman, 2004, p. 62].

➤ **Types of Surfactants:**

Surfactants may be classified according to the ionic nature of the head group as anionic, cationic, nonionic, and zwitterionic (Ottewill, 1984):

**1. Anionic Surfactants**

Anionic surfactants are negatively charged. They are commonly used for various industrial applications, such as detergents (alkyl benzene sulfonates), soaps (fatty acids),

foaming agents (lauryl sulfate), and wetting agents (di-alkyl sulfosuccinate). Anionic surfactants are also the most commonly used in EOR. They display good surfactant properties, such as lowering the IFT, their ability to create self-assembled structures, are relatively stable, exhibit relatively low adsorption on reservoir rock and can be manufactured economically [Green & Willhite, 1998, p. 241]. Anionic surfactants dissociate in water to form an amphiphilic anion (negatively charged) and a cation (positively charged), which would typically be an alkaline metal such as sodium (Na<sup>+</sup>) or potassium (K<sup>+</sup>).

## 2. Nonionic Surfactants

Nonionic surfactants have no charged head group. They are also identified for use in EOR, [Gupta and Mohanty, 2007], mainly as co-surfactants to promote the surfactant process. Their hydrophilic group is of a non-dissociating type, not ionizing in aqueous solutions. Examples of nonionic surfactants include alcohols, phenols, ethers, esters or amides.

## 3. Cationic Surfactants

Cationic surfactants have a positively charged head group. Cationic surfactants dissociate in water, forming an amphiphilic cation and anion, typically a halide (Br<sup>-</sup>, Cl<sup>-</sup> etc.). During the synthesis to produce cationic surfactants, they undergo a high pressure hydrogenation reaction, which is in general more expensive compared to anionic surfactants. As a direct consequence cationic surfactants are not as widely used as anionic and nonionic surfactants [Standnes & Austad, 2002].

<b>Anionic</b>	
Sodium dodecyl sulfate (SDS)	$CH_3 (CH_{11}) SO_4^- Na^+$
Sodium dodecyl benzene sulfonate	$CH_3 (CH_2)_{11} C_6H_4 SO_3^- Na^+$
<b>Cationic</b>	
Cetyltrimethyl ammonium bromide (CTAB)	$CH_3 (CH_2)_{15} N (CH_3)^+_3 Br^-$
Dodecylamine hydrochloride	$CH_3 (CH_2)_{11} NH_3^+ Cl^-$
<b>Non-ionic</b>	

**Table 2-2: Anionic and Nonionic Surfactants****4. zwitterionic surfactants :**

The types of zwitterionic surfactants can be nonionic-anionic, nonionic-cationic, or anionic-cationic. Such surfactants are temperature and salinity-tolerant, but they are expensive. A term amphoteric is also used elsewhere for such surfactants (Lake, 1989).

**➤ Surfactant flooding process**

After the surfactant solution has been injected into the formation targeting the surface between oil/water to break the attractive forces between them IFT by producing soaps at the contact reducing residual oil saturation in addition wettability change from oil wet to water wet followed by polymer injection to enhance the sweep efficiency and control the mobility as well as to stabilize the flow pattern.

By designing and selecting series of specialty surfactants to lower the interfacial tension to the range of 10 – 3 dynes/cm a recovery of 10 – 20 % of the OIIP will not be producible by other technologies is technically and economically feasible by surfactant flooding (akzonobe, 2006).

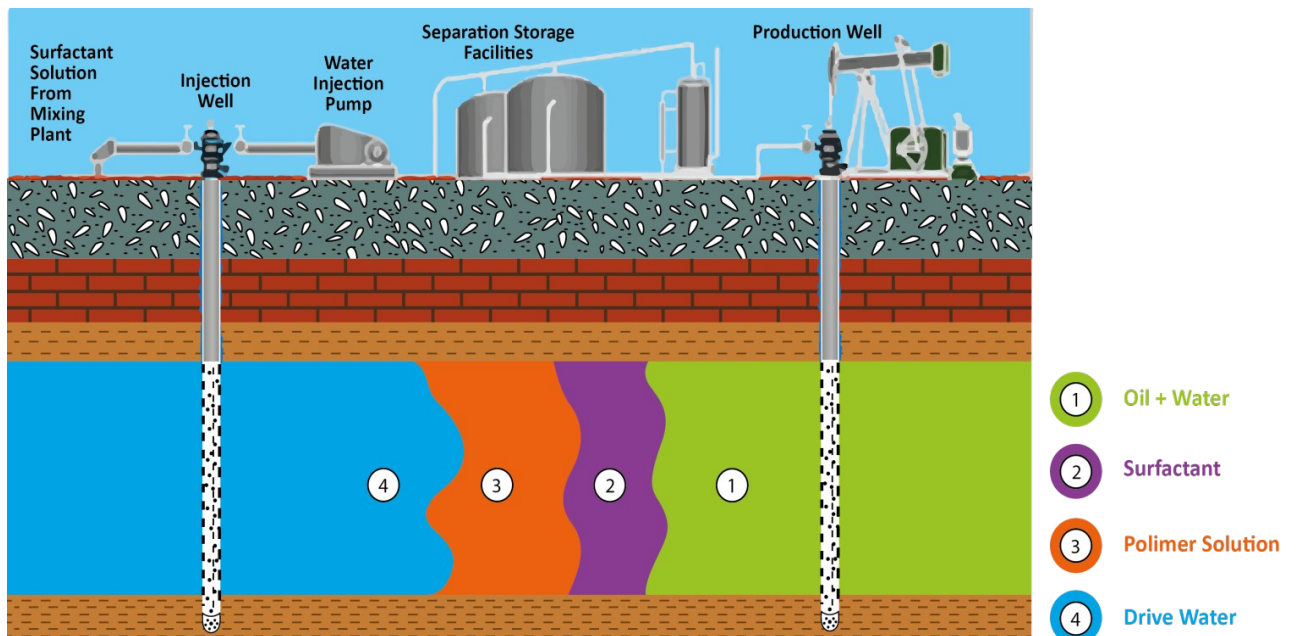

**Figure 2-6: Mechanism of chemical flooding (Abdulbasit, 2013).**

➤ **Effect of salinity on surfactant flooding (Teknika, 2001):**

A specific surfactant concentration and salinity is required for the formation of ultra-low IFT. As the salt concentration varies in aqueous phase, the partition coefficient of the surfactant between oil and water is altered which seems to be responsible for achieving ultra-low IFT. The surfactant concentration in the oil phase increases with increasing salt concentration in the aqueous phase and vice versa. Select optimal salinity in such a way that surfactant concentration is highest at the oil-water interface which produces the lowest IFT.

➤ **The success of surfactant flooding EOR depends on:**

1. Formulation.
2. Cost of surfactant.
3. Availability of chemicals.
4. Environmental impact.
5. Oil price.

➤ **Advantages:**

1. Reduce IFT and work as emulsifier between oil and water.
2. Sour reduction to a very minimum value which immediately leads to increase in recovery factor.
3. Wettability change from oil to water wet .
4. Trapped oil is produced
5. Injection of polymer leads to pattern flow stabilization and mobility control.

➤ **Disadvantages and limitations :**

1. Complex process
2. Expensive compared to alkaline and polymer.
3. Incompatibility between surfactant polymers in case of no co-solvent is used.
4. Degradation of surfactant and polymer in case of high reservoir temperature.
5. Strong aquifer leads to both surfactant and polymer adsorption.



## 2.2 Literature review

Adding surfactant to injected water to reduce oil/water IFT and/or change wettability and thereby increase recovery [Uren and Fahmy (1927)]. A few early field experiments where small amounts of surfactant were injected did produce small increases in oil recovery. The increases were probably caused mainly by wettability changes. The results were not sufficiently promising to stimulate use of surfactants on a larger scale. A related concept for improving recovery is to generate surfactant in-situ by injecting an alkaline solution (Atkinson 1927), which is less expensive than synthetic surfactants and converts naphthenic acids in the crude oil to soaps.

Dimensionless capillary number ( $N_c = \mu v / \sigma$ ) control the amount of residual oil remaining after flooding. A Core containing oil at velocity  $v$  with an aqueous solution having a viscosity  $\mu$  and IFT  $\sigma$  between the oil and the displacing fluid (Taber 1969).

Several researchers found that ultralow IFTs in the required range could be achieved by using petroleum-sulfonate/alcohol mixtures. They also found systematic variations of IFT when changing such variables as salinity, oil composition, and temperature (Hill et al. 1973; Foster 1973; Cayias et al. 1977).

Microemulsions are oil-swollen micelles in water at under optimum conditions and water micelles in oil at optimum conditions. It was once thought that it is necessary to have a cosolvent (alcohol) to have a microemulsion with an anionic surfactant. However, it is now recognized that it is possible to have microemulsions without alcohol at room temperature by using branched surfactants (Abe et al. 1986).

(Sume Sarkar, 2012) he investigated the effect of chemical flooding which is ASP (alkali, surfactant and polymer) flooding in the Norne E-segment for various scenarios by using

applied reservoir simulation software (Eclipse). Though the results were good but not as expected, he found out that shorter time periods, and also cyclic injection were much more profitable than continuous and long period injections, a five years injection period prove more profitable than 7 years period. He also injected different concentrations from two types of surfactants and it turned out that increasing the amount of chemicals did not necessarily give an increase in oil production. Higher concentrations gave higher oil production rate and higher cumulative oil production, but it did not prove to be profitable due to the cost of chemicals, applying a concentration between 0.5–10 kg/m<sup>3</sup> of ASP chemicals gave the best result.

(Yongwei Li & Lizhong Yin, 2013) They did a new surfactant flooding model for Low Permeability Reservoirs, in Chao 522 Block of “Chaoyanggou” low permeability oilfield which was already going under pilot testing. They presented a three-dimensional, two phases, three component surfactant simulator. They also introduced new equation for the calculation of surfactant adsorption, which can increase the matching degree between the mathematical model and data from field. The goal of this new simulator is to help the decision-making in surfactant EOR projects, and to find the best methods of field development.

There were 4 injectors and 10 production wells in the pilot area. Four injection wells started injecting water from January 2002. To January of 2005, just before the start of pilot test, the designed water injection rate was 122.5 m<sup>3</sup>/d, the actual water injection was 98.3m<sup>3</sup>/d.

The injection method in the pilot testing was as the following; Main surfactant slug, Water slug, secondary surfactant slug, and then water drive. They founded that the most favorable surfactant concentration was 1.0%. Volume of each and every slug was 0.10 PV.

They found out from laboratory experiments that surfactant flooding lowered the injection pressure by more than 40%, and increased the oil recovery efficiency of low permeability reservoir by 5.0% of OOIP at Chao-522 reservoir conditions. The pilot tests also showed that surfactant flooding can increase the water infectivity in low permeable

layers, and increase number of displaced zones; increase the oil production rate to maximum of 3%.

(Farid Abadli, 2012) he did a simulation study to improve total oil production using different chemical flooding methods such as:(surfactant flooding, polymer flooding, Alkaline flooding, SP, ASP flooding) under many different scenarios and factors, based on model of Norne field C-segment using Eclipse software. The black oil model was used for simulations. He did sensitivity analyses especially focusing on chemical concentration, injection rate and duration of injection time, our main focus here is going to be on the results of the surfactant flooding study.

The simulated Norne C-segment field has 13 active wells including 9 producers and 4 injectors.

He chose three different surfactant concentrations at 15kg/m<sup>3</sup>, 25kg/m<sup>3</sup>, 40kg/m<sup>3</sup>. And injection was set starting from 2013 to the end of 2016.

The results of simulations showed that surfactant flooding increased oil production compared with water flooding. With the increase of surfactant concentration water production is reduced. The study also showed that with small effect on recovery between three concentrations, makes it possible that 15kg/m<sup>3</sup> could be better choice considering economic side. Also higher amount of chemicals is produced in higher concentration.

From the final results of his research (Farid Abadli, 2012 ) recommended surfactant flooding for the Norne C-Segment especially when the concentration is low and injection occurs in the early years. Injection of surfactant at a later time might not be profitable. Also longer injection period in early life of simulation leads to higher oil production.

(Sumit Kumar Rai, Achinta Bera & Ajay Mandal, 2014) They made a research to investigate the surfactant solution in terms of its ability to reduce the surface tension and the interaction between surfactant and polymer in its aqueous solution. A series of flooding experiments have been carried out to find the additional recovery using surfactant and surfactant–polymer slug. Approximately 0.5 pore volume (PV) surfactant (sodium dodecylsulfate) slug was injected in surfactant flooding, while 0.3 PV surfactant

slug and 0.2 PV polymer (partially hydrolyzed polyacrylamide) slug were injected for surfactant–polymer flooding. In each case, water injection was used to maintain the pressure gradient. Their objective is to determine whether or not a commercially available simulator (CMG-STARs) could accurately simulate results from core flooding experiments.

Two sets of experimental data have been modeled and matched using physically realistic input parameters. The first experiment consisted of a surfactant injection which was carried out after water flooding in a sand pack. According to surfactant flooding simulation, the additional recovery after water flooding was found to be 17.65 % which is comparable with the experimental results (18%).

The second experiment was conducted on a different sand pack. It consisted of surfactant polymer flooding. According to chemical flooding simulation, the additional recovery after water flooding was found to be 24 % which compares to the experimental result of (23.45%).

Flooding agents	Additional oil recovery, %OOIP	
	Experimental results	Simulated results
Surfactant	18	17.65
Surfactant-polymer	23.45	24

**Table 2-3 shows comparison between experimental and simulator results (Sumit Kumar Rai, Achinta Bera & Ajay Mandal, 2014).**

Also, it was observed that the additional oil recovery in case of surfactant–polymer flooding was greater than when only surfactant was used. This is because of the contribution of IFT reduction using surfactant and mobility ratio reduction by polymer, thus improving the overall sweep efficiency more than with surfactant flooding where only IFT reduction is available.

(Rabia Mohammed Hunky & etl, 2010) They did an experimental study of alkaline-surfactant flooding in ultra-shallow heavy oil reservoirs (<500 ft). The study was done on Pennsylvanian warner sand in western Missouri, they tested more than 30 commercial surfactants, and using sands saturated with heavy oil (API 17).

It has been found that a few surfactants can make stable emulsion with the warmer heavy oil and the formation brine. In all cases examined the highest recovery is from water wet sands. The study founded that using these surfactants is better than using the commonly used surfactants. The study also showed that the viscosity of Missouri heavy oil can be reduced from 18518 cp to 2.5 cp at 25 C°, through emulsion of a certain surfactants. The emulsions were stable after weeks at 25 C°. Alkaline-surfactant (AS) system can change wettability from oil wet to water-wet.

By using Alkaline-surfactant (AS) system, the tertiary heavy oil recovery from water-wet sand pack can reach up to 12% of remaining oil in place.

(George J. Hirasaki & et al, 2008) They presented a paper at the SPE Annual Technical Conference and Exhibition, Denver, September 2008. They found out that Surfactant adsorption can be reduced in by big difference sandstone and carbonate formations by injection of an alkali such as sodium carbonate. The reduced adsorption allows lower surfactant concentrations. Also they found out that Anionic surfactants and sodium carbonate can make changes on wettability for either sandstone or carbonate formations. oil displacement can happen just by the effect gravity drainage.

EOR in Sudan

(Wang Qiang, Mohamad Abu Bakar, el al, and 2013) they did a study about the ability of chemical EOR in both GNPOC and PDOC fields in Sudan, from the initial EOR screening, the best EOR processes that can be chosen in both GNPOC and PDOC are mainly chemical and thermal EOR. Chemical EOR is the most widely used EOR process in GNPOC fields, but thermal EOR is the most commonly used EOR process in PDOC fields.

They did Chemical EOR evaluation using Eclipse EOR black oil simulator. Simulations were done on sector models taken from full field models, which made to look like the reservoir condition now. The chemical input data was taken from Qing Hai oil field lab data which its oil properties are similar to that of Sudan's. The chemical EOR methods are:

- Polymer flooding.
- Surfactant-Polymer (Sp) Flooding.
- Alkaline-surfactant-polymer (asp) flooding.

They found out that chemical EOR can possibly increase field recovery factor between 4-18% depending on the type of chemical EOR method. ASP flooding gives the highest increase in oil recovery after waterflood ranging between 12%-18%, then SP flooding and after that polymer flooding.

## **3 Chapter 3: Methodology**

### **3.1 Introduction**

In this chapter the procedure followed to get the results will be discussed, the main stages of the project can be stated as the following:

- Collecting all data required.
- Technical Screening criteria to evaluate the initial amenability of the EOR process.
- Building the model.
- Running the chemical EOR process, (surfactant flooding one component).
- Displaying the results in forms of graphs and tables.
- Discussing the results and forming the conclusions.

### **3.2 Screening criteria:**

EOR screening is the first step to do EOR project implementation in the field SPE (Society of Petroleum Engineers) has established technical EOR screening concepts using certain format, This format is based on field experience, project implementation around the world, this method was the start point of all EOR screening softwares, the objective is to select the suitable EOR method to be implemented in the future.

**The procedure contains five plots:**

- Permeability Vs. EOR methods
- Viscosity Vs. EOR methods
- Depth Vs. EOR methods
- Reservoir Depth Vs. Oil Viscosity
- Reservoir Pressure Vs. Viscosity

The final screening result based on the combination between the five plots. It is not necessary to use all the plots to take the decision in the selection of the suitable EOR method.

➤ **Screening Properties:**

Layer	Sw	So=1-Sw
Layer 1	0.239	0.761
Layer 2	0.239	0.761
Layer 3	0.239	0.761
Layer 5	0.549	0.451
Layer 7	0.582	0.418

**Table 3-4 saturations of layers**

K=2500 md

Depth =1290 m=4232 ft

Oil API = 39

PRESSURE=1873 psi

Viscosity = 76 cp

**1. Permeability (k=2500md) Vs EOR methods**

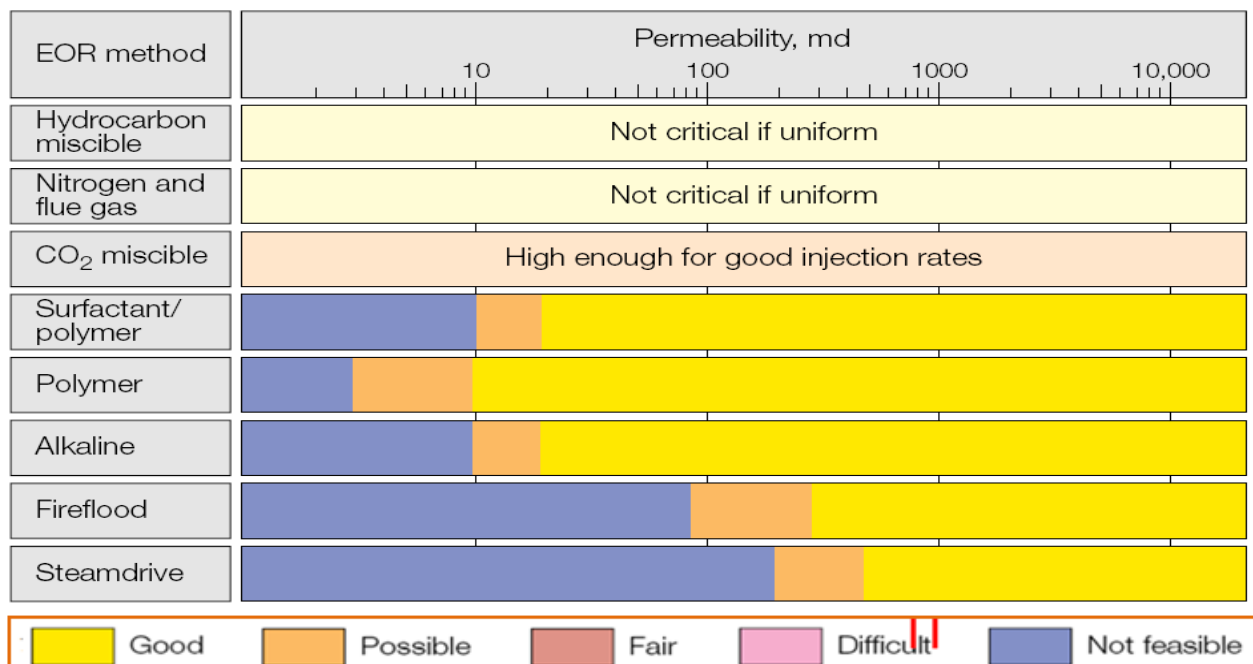

**Figure 3-7: Permeability (k=2500md) Vs EOR method**

### 2. Viscosity ( $\mu=76$ cp) Vs EOR methods

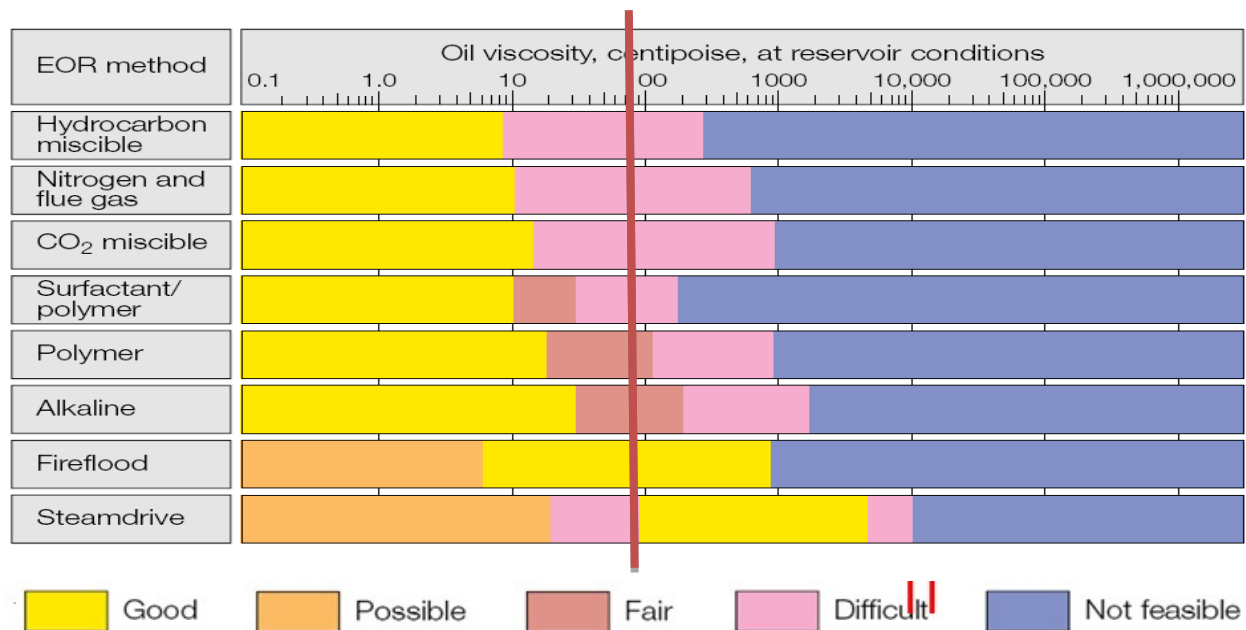

**Figure 3-8: Viscosity ( $\mu=76$  cp) Vs EOR methods**

### 3. Depth (4232 ft) Vs. EOR methods



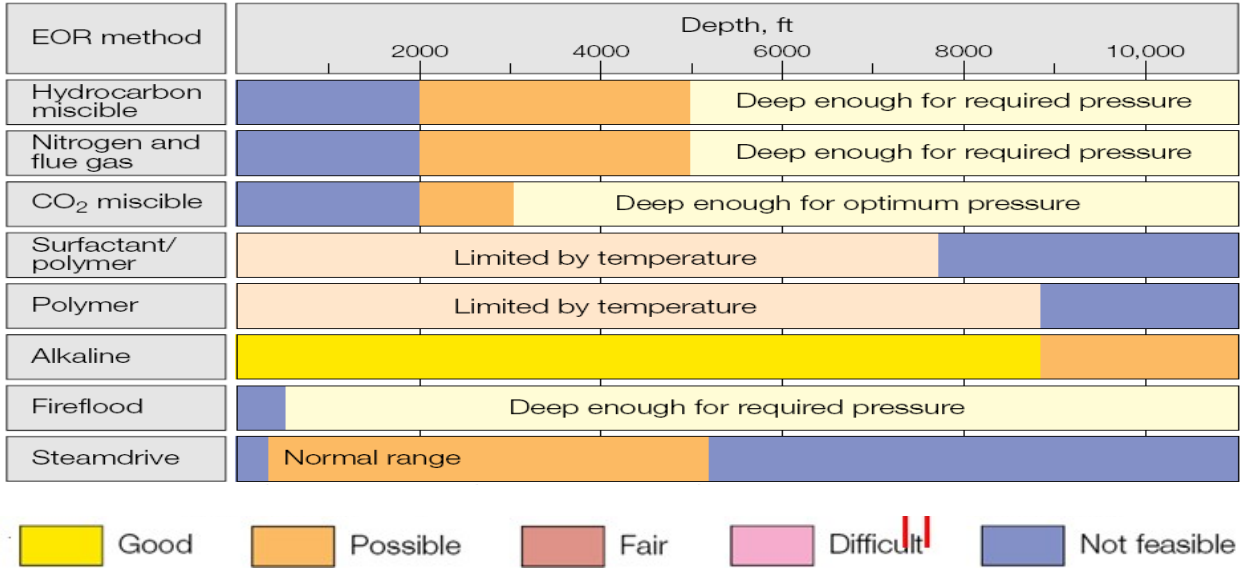

Figure 3-9: Depth (4232 ft) Vs. EOR method

4. Reservoir Pressure (1873 psi) Vs. Viscosity (76 cp)

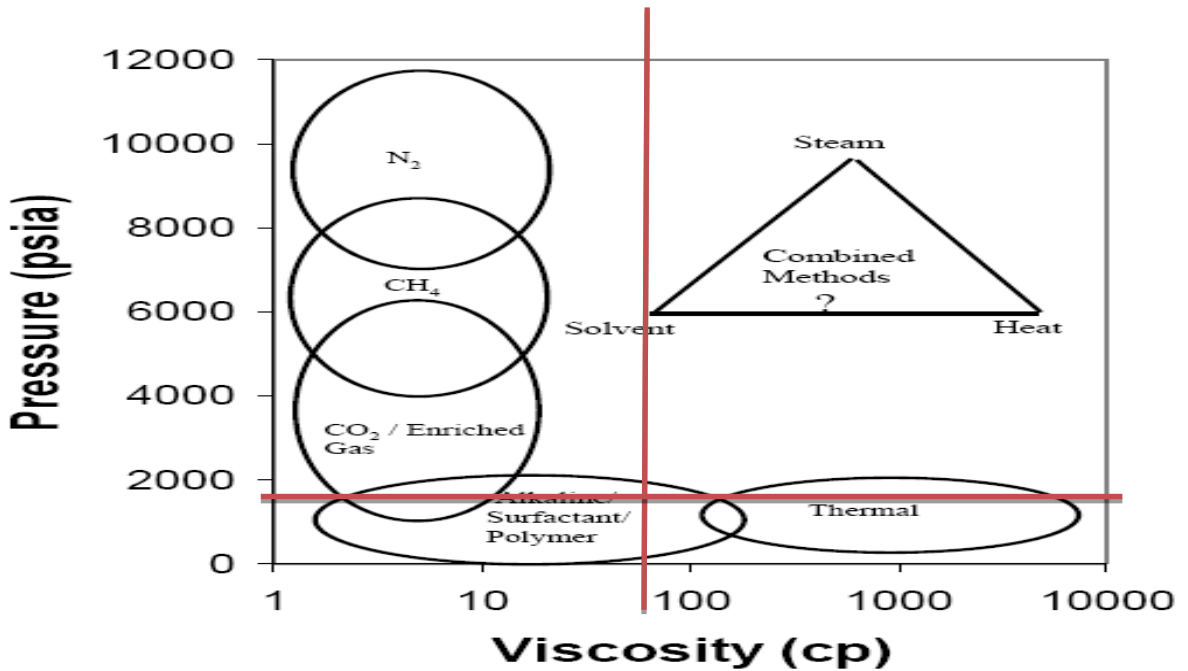
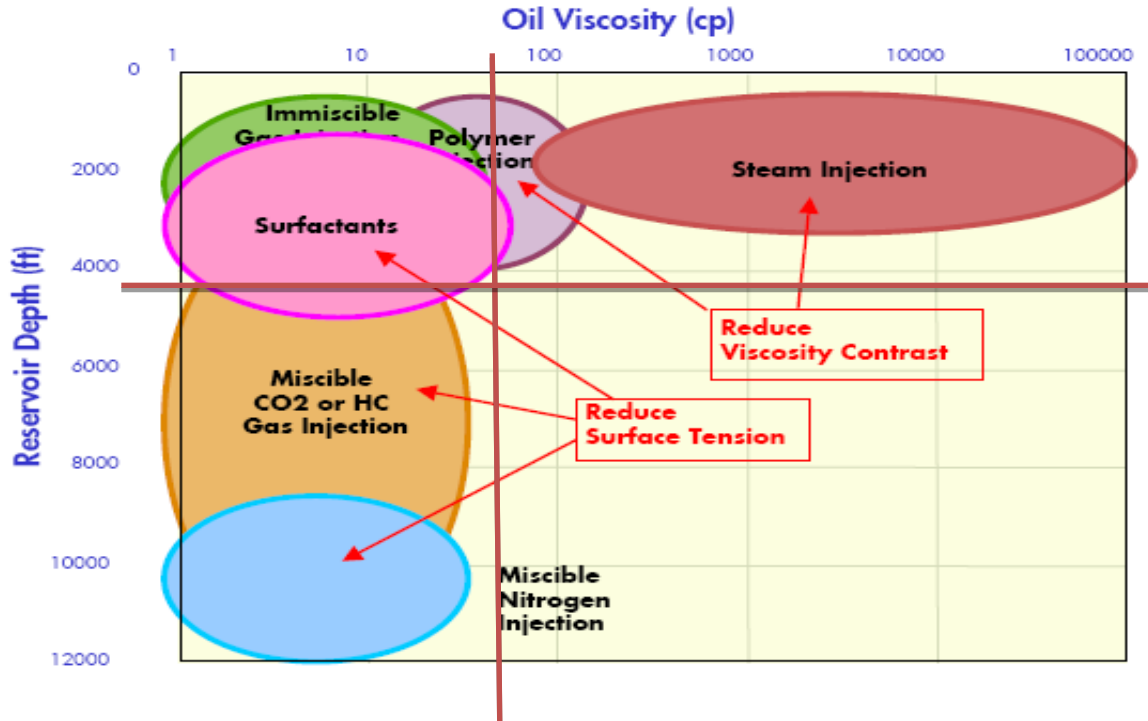

Figure 3-10: Reservoir Depth (4232 ft) Vs. Oil Viscosity ( $\mu=76$  cp)

5. Reservoir Depth (4232 ft) Vs. Oil Viscosity ( $\mu=76$  cp)



**Figure 3-11: Reservoir Depth (4232 ft) Vs. Oil Viscosity ( $\mu=76$  cp)**

As we can see from the results of the SPE screening criteria formats, most of the screening variables agree with the surfactant flooding process, even though the viscosity is not on the optimum range for this method but it is still feasible, we can refer here to a research done in screening and modeling in Sudanese oil fields by Eng. Khalil Ishag Abdallah 2011 he stated in his M.Sc. research results that “Chemical flooding can be considered feasible for areas of viscosity less than 125 cp. However, it is important to take into consideration factors that can reduce its effectiveness such as: reservoir heterogeneity”.

### 3.3 Simulation and modeling

Before discussing the steps of building the model and getting the results we ought to give first a brief introduction about the software we used in this process which is CMG.

#### ➤ CMG

Computer Modeling Group Ltd., abbreviated as CMG, is a software company that produces reservoir simulation software for the oil and gas industry. It is based in Calgary, Alberta, Canada with branches over the world. The company offers three reservoir

simulation applications. IMEX, a conventional black oil simulator used for primary, secondary and enhanced or improved oil recovery processes; GEM, an advanced Equation-of-State (EoS) compositional and unconventional simulator; and STARS a thermal an advanced chemical processes simulator. In addition, CMG offers CMOST, a reservoir engineering tool that conducts automated history matching, sensitivity analysis and optimization of reservoir models.

### ➤ Stars

STARS is CMG's new generation advanced processes reservoir simulator which includes options such as chemical/polymer flooding, thermal applications, steam injection, horizontal wells, dual porosity/permeability, directional permeabilities, flexible grids, fireflood, and many more. STARS was developed to simulate steam flood, steam cycling, steam-with additives, dry and wet combustion, along with many types of chemical additive processes, using a wide range of grid and porosity models in both field and laboratory scale.

### 3.3.1 Building the model:

#### Step 1: Open Builder

#### Step 2: Create grids (using quick pattern)

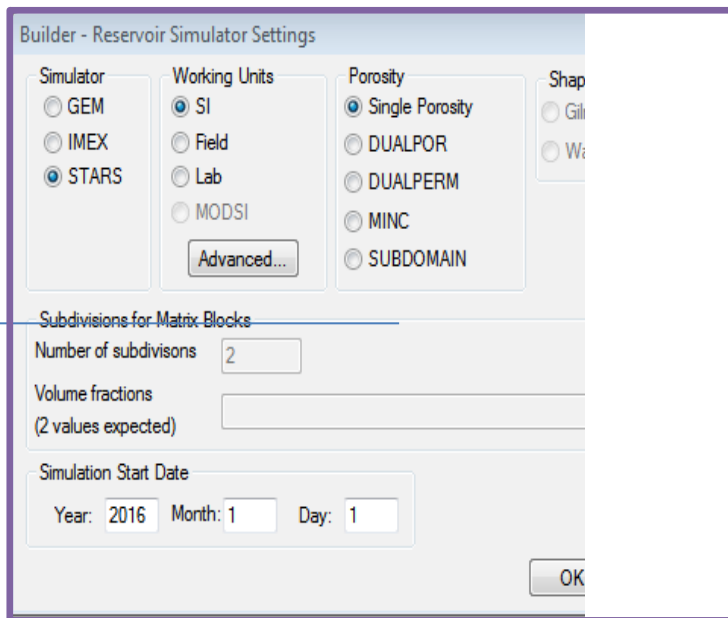

Figure 3-12: Open Builder

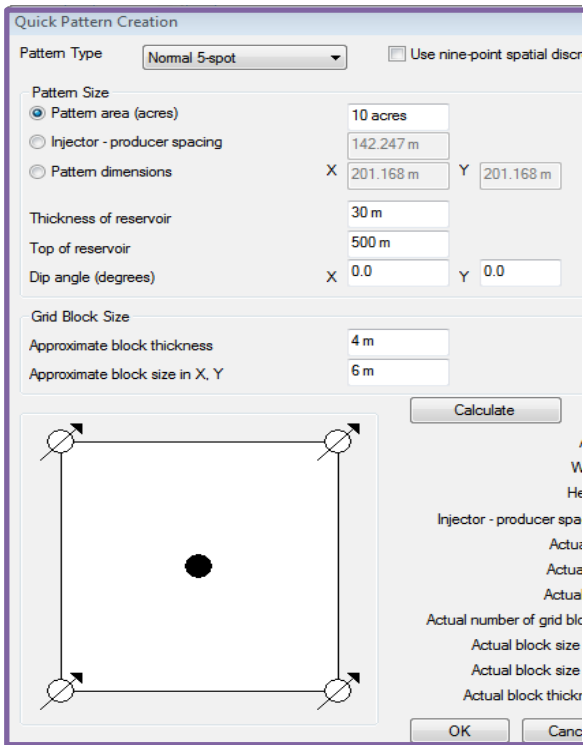
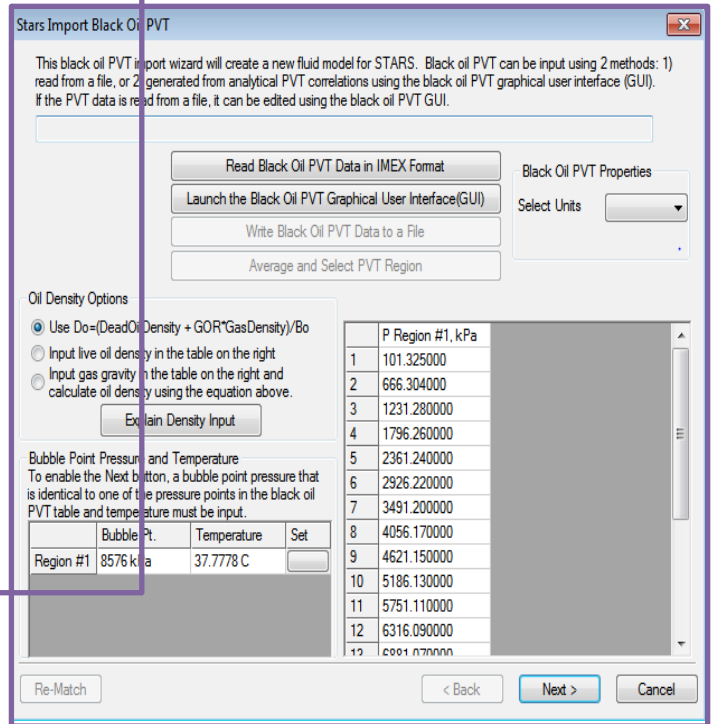

Figure 3-13: create grids.

**Step 4: Create fluid model data (generate PVT data using correlations)**



**Figure 3-15: Create fluid model data (generate PVT data using correlations)**

**Step 3: Enter reservoir general specifications (specify property)**

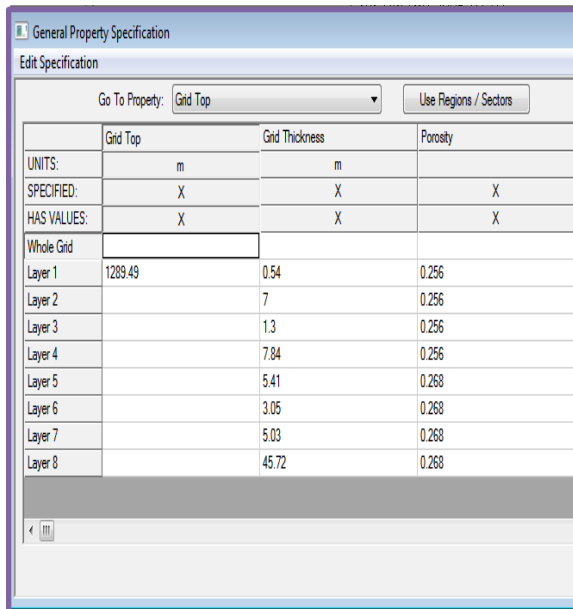

Figure 3-14: : Enter reservoir general specifications (specify property)

**Step 5: Create relative permeability data**

	Sw	krw	krow	Comment
1	0.3	0	0.96	
2	0.4	0.0168	0.68	
3	0.5	0.0377	0.46	
4	0.6	0.0595	0.2677	
5	0.7	0.0793	0.143	
6	0.8	0.1199	0.073	
7	0.9	0.176	0.027	
8	1	0.2666	0	
9				
10				

Figure 3-16: : Create relative permeability data

**Step 6: Create the initial conditions**

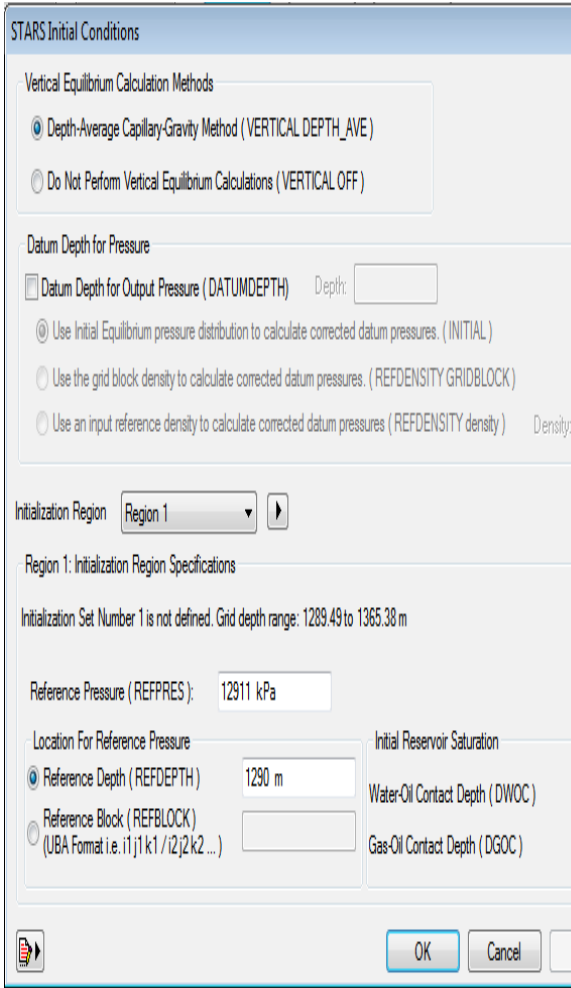

Figure 3-17: Create the initial conditions.

Step 7: Choose numerical controls (timestep)

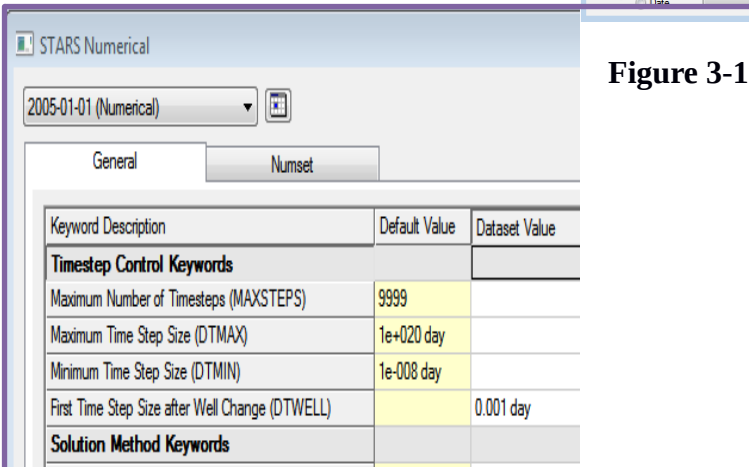

Figure 3-18: Choose numerical controls (timestep).

Step 8: Create wells (define wells specifications)

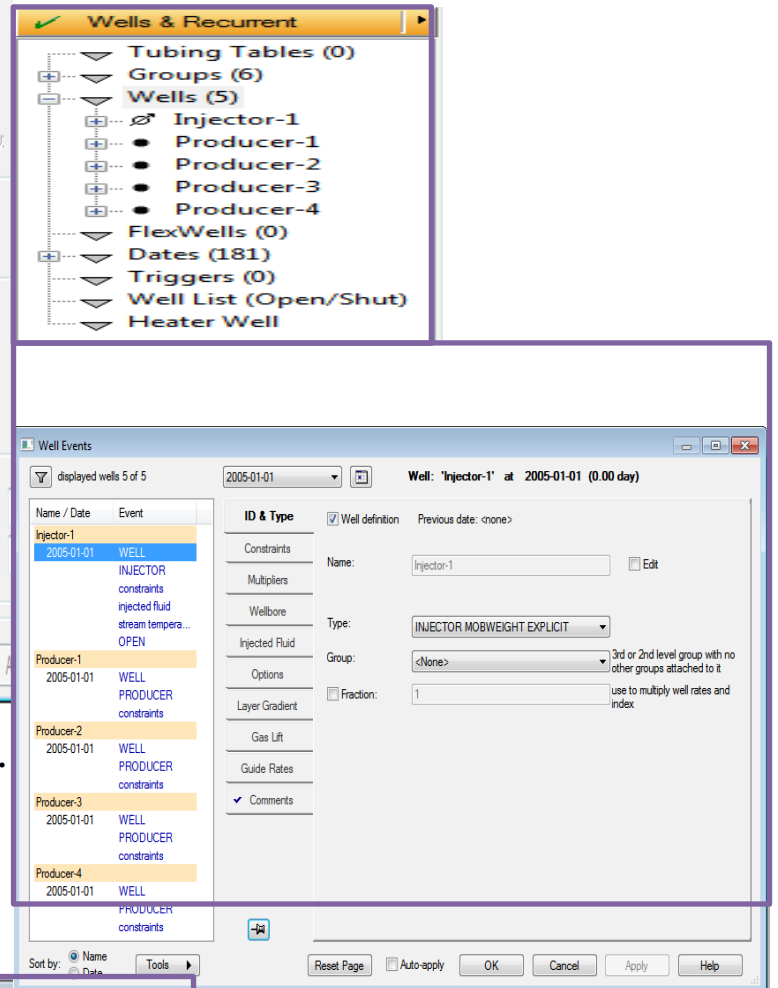

Figure 3-19: Create wells (define wells specifications).

### Step 9 : Select range of dates for running the model (start-end dates)

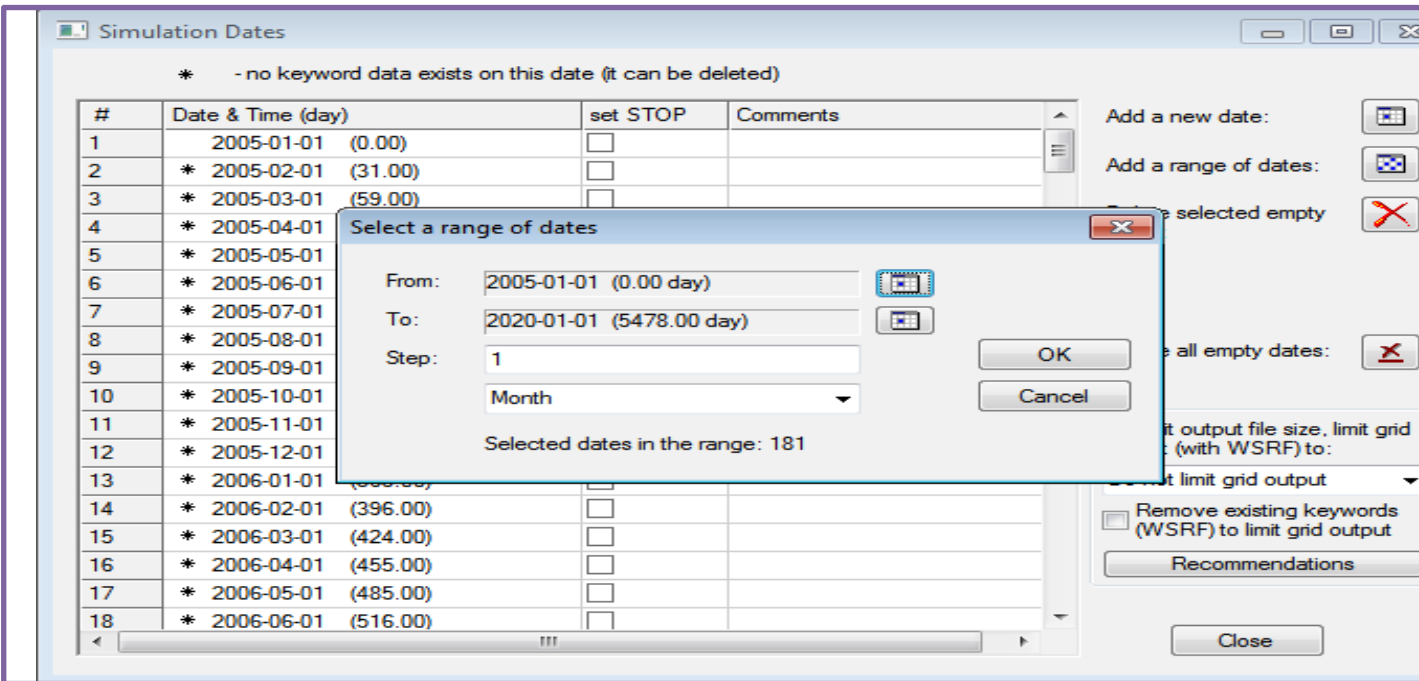

Figure 3-20: Select range of dates for running the model (start-end dates).

Now all the ticks next to the model tree components should turn green (model can be run)

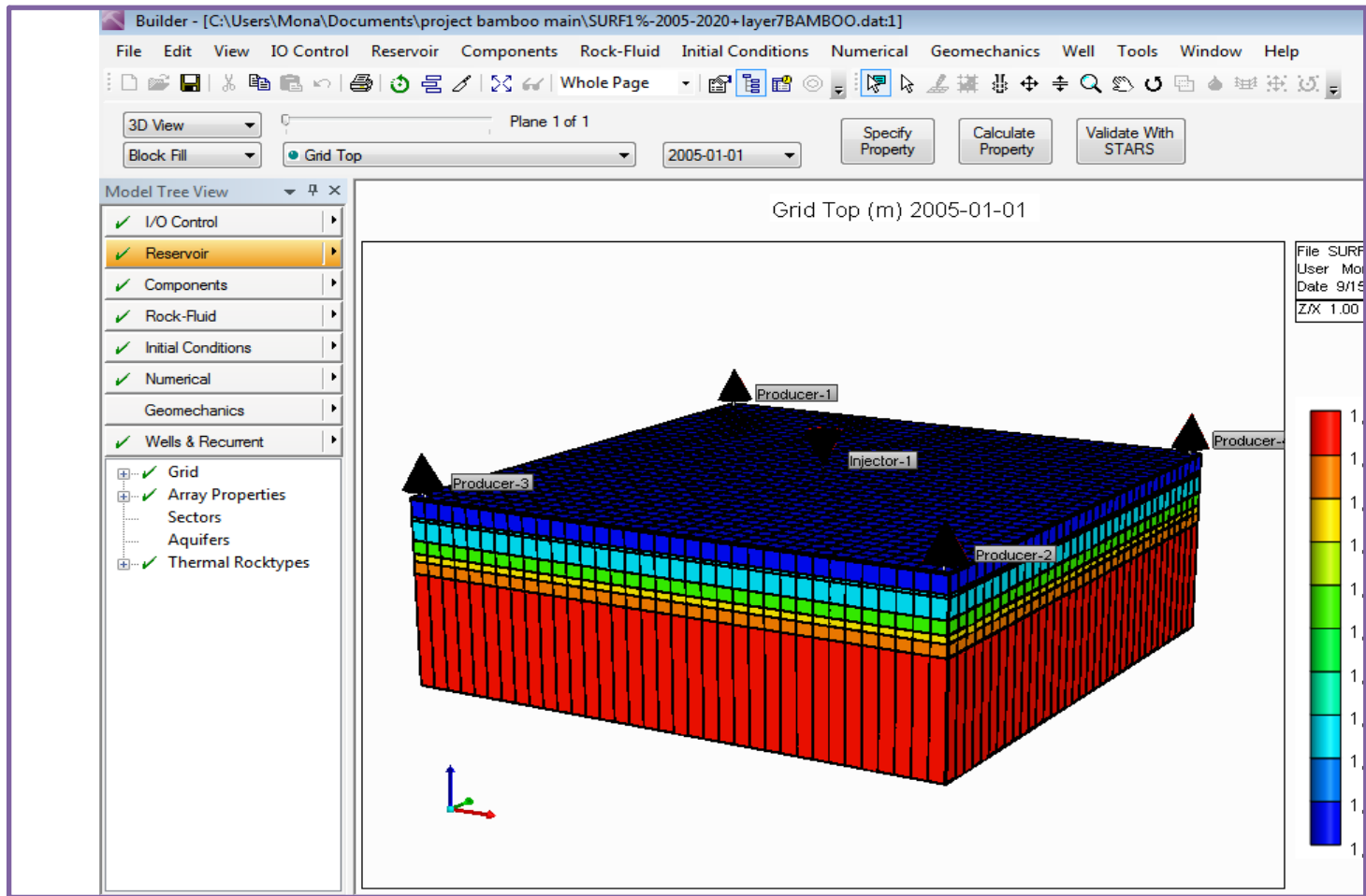
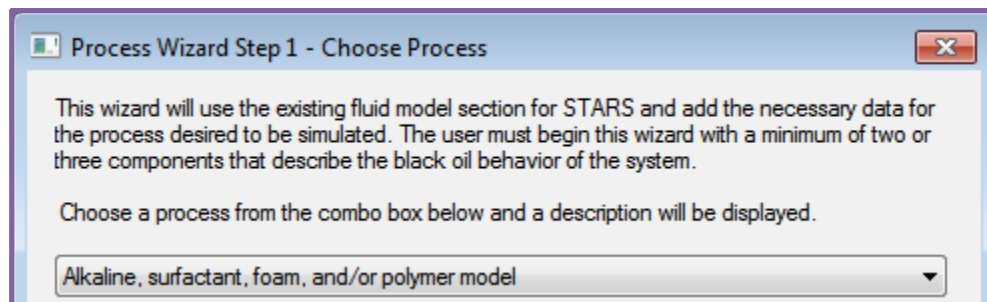

Figure 3-21: model ready to run.

### 3.3.2 Steps for implementing the process (in our case surfactant flooding):

**Step 1: On the component section of model tree open process wizard**

**Step 2: Choose the process you want to run.**



**Figure 3-22:choose process.**

**Step 3: Select number of components for the chemical flooding (In our case one component surfactant only).**

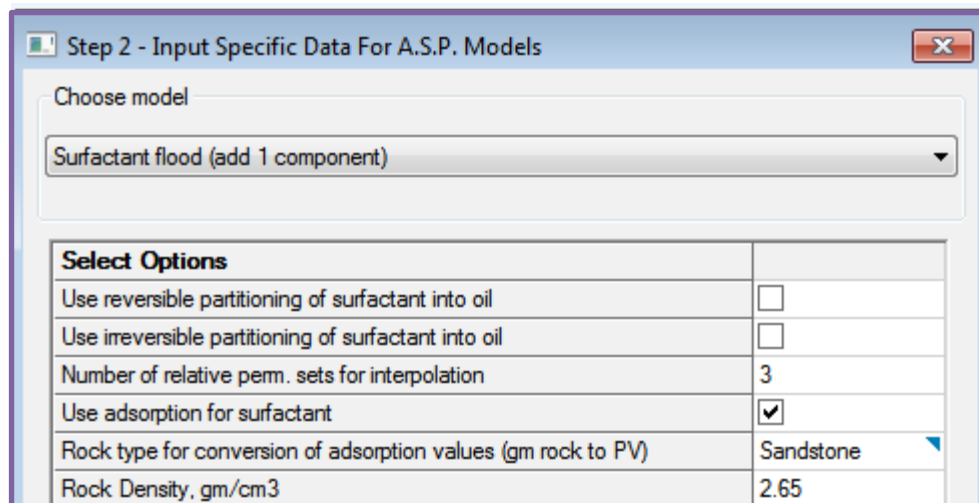

**Figure 3-23:Number of components.**



**Step 4: Fill the surfactant concentrations VS IFT table and the adsorption values table.**

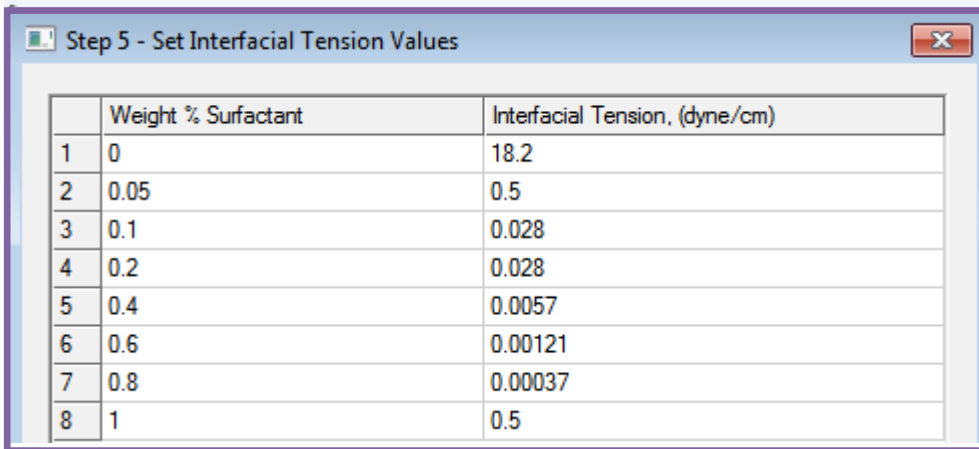

	Weight % Surfactant	Interfacial Tension, (dyne/cm)
1	0	18.2
2	0.05	0.5
3	0.1	0.028
4	0.2	0.028
5	0.4	0.0057
6	0.6	0.00121
7	0.8	0.00037
8	1	0.5

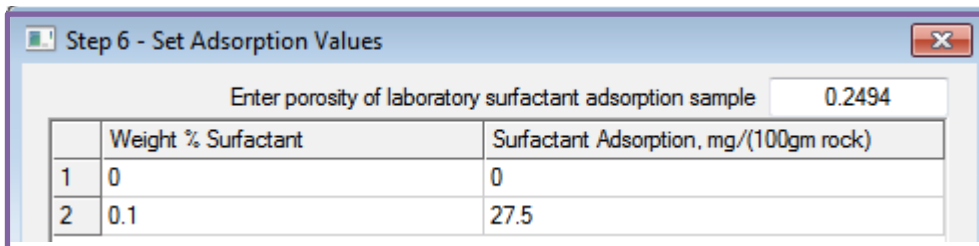

Enter porosity of laboratory surfactant adsorption sample

	Weight % Surfactant	Surfactant Adsorption, mg/(100gm rock)
1	0	0
2	0.1	27.5

**Figure 3-24:Surfactant data.**

**Step 5: Changing surfactant concentration (mole fraction %)**

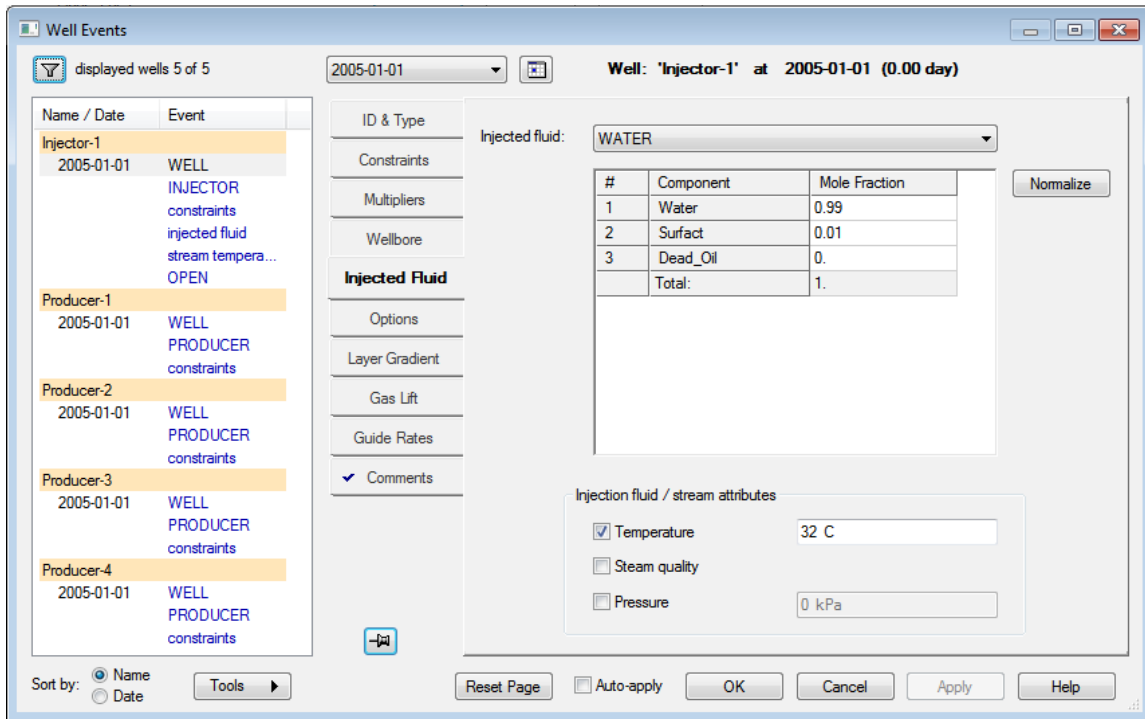

Figure 3-25: Changing surfactant concentration.

### Step 6: Changing the injection rate

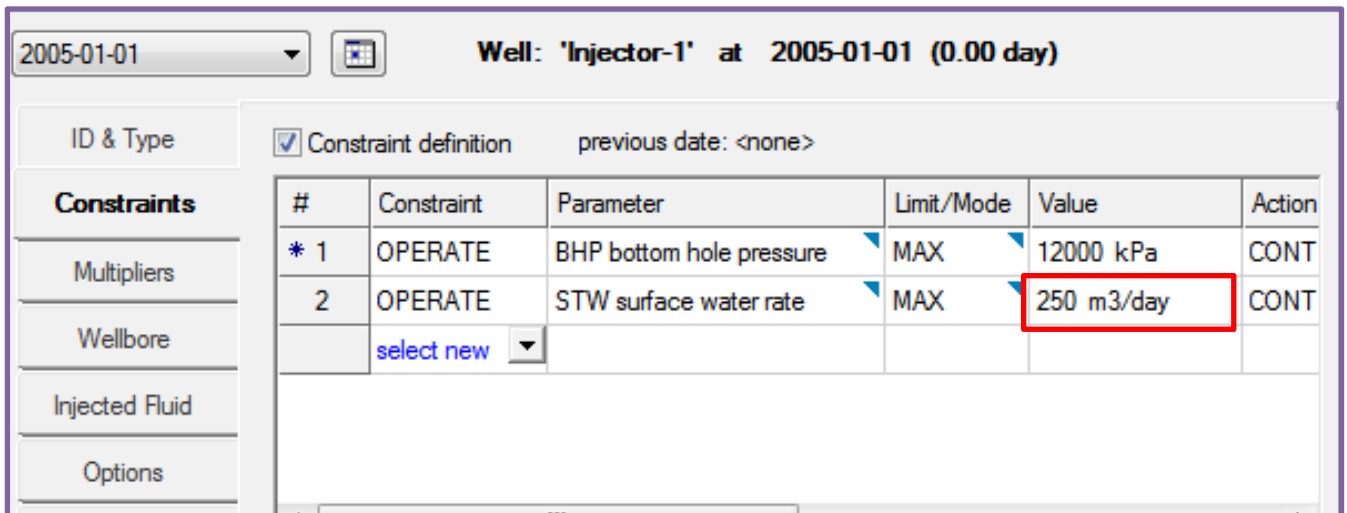

Figure 3-26: Changing the injection rate.

### 3.3.3 Displaying the results

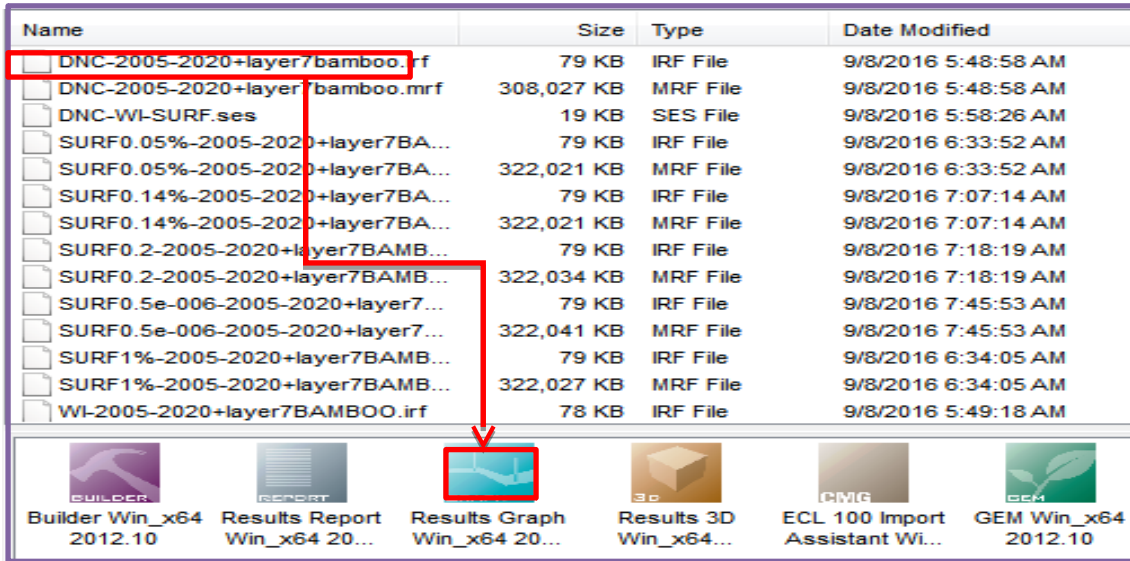

Figure 3-27: Displaying the results.

### Choosing graph variables on X-axis and Y-axis

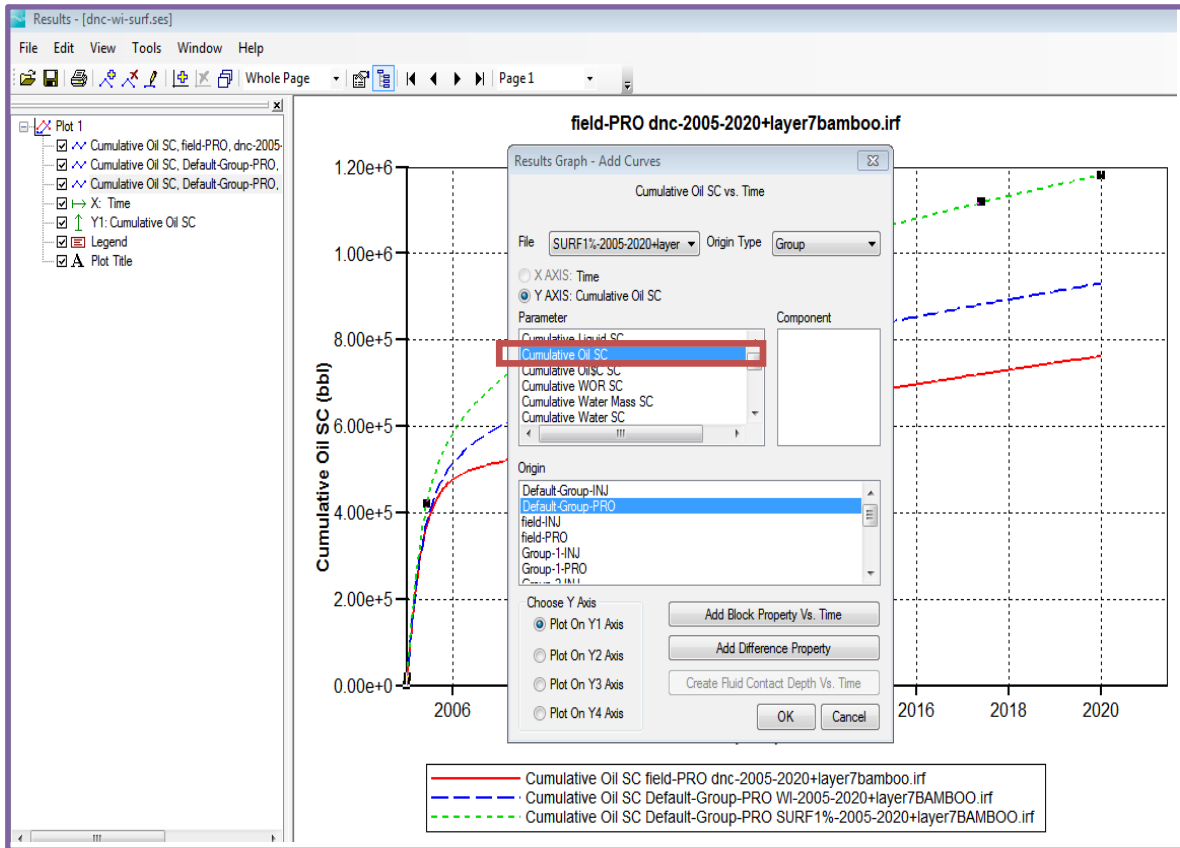

Figure 3-28: Choosing graph variables.

## **4 Chapter 4: Result and discussion**

### **4.1 Introduction**

In this chapter the results of the simulations will be displayed in form of tables and graphs, the discussed results will include surfactant concentrations (mole fraction) against cumulative oil production (bbl), and water cut percentage, also injection rates ( $\text{m}^3/\text{day}$ ) against cumulative oil production (bbl) and water cut percentage, in addition different surfactant injection periods will be investigated, every parameter will be studied at five different values in a duration from Jan 2005 to Jan 2020, based on these results a comparison will be made and decision will be made on the optimum variables for the best surfactant flooding scenario.

It's important to state that this model we have built to acquire the results in this chapter is not the actual field model with the real data, since the real model is still under development in china as we have been informed by the reservoir engineers in the oil ministry of Sudan. This model is built to resemble the actual reservoir behavior and conditions, by entering the reservoir and fluid properties we had access to, and in the process some assumptions were made such as: homogenous porous media, and five spot pattern, and default CMG data for surfactant.

### **4.2 Input data to CMG**

Here the data entered to CMG from rock to fluid properties to surfactant properties is specified in the form of tables below:

## 1. Rock Properties

	Grid top (m)	Grid thickness (m)	Porosity	Permeability I	Permeability J	Permeability k	Water saturation
<b>Layer1</b>	1289.4 9	0.54	0.256	2500	2500	1250	0.239
<b>Layer2</b>	1290	7	0.256	2500	2500	1250	0.239
<b>Layer3</b>	1297	1.3	0.256	2500	2500	1250	0.239
<b>Layer4</b>	1298.3	7.84	0.256	100	100	50	0.239
<b>Layer5</b>	1306.1 4	5.41	0.268	2500	2500	1250	0.549
<b>Layer6</b>	1314.6	3.05	0.268	100	100	50	0.549
<b>Layer7</b>	1319.6 3	5.03	0.258	2500	2500	1250	0.582
<b>Layer8</b>	1319.6 3	45.72	0.258	5	5	2.5	0.582

**Table 4-5: Rock Properties for BB-21 Well**

## 2. Fluid properties

We have only two phases (water & oil) and their properties are illustrated below in the following two tables, see table (4-2) and table (4-3).

➤ For water phase

Property	Water Phase
<b>FVF (bbl./STB)</b>	1
<b>density (g/cm<sup>3</sup>)</b>	1
<b>viscosity (cp)</b>	0.449

**Table 4-6: Property of Water Phase**

➤ For oil phase

Property	Oil phase
<b>FVF (bbl/STB) @<math>10 \times 10^6</math> Pa</b>	0.866
<b>density (g/cm<sup>3</sup>)@ <math>10 \times 10^6</math> Pa</b>	0.826
<b>viscosity (cp)</b>	76
<b>gas oil ratio</b>	0

**Table 4-7: Property of Oil Phase**

### 3. Initial conditions

The initial condition of the reservoir is shown below in table (4-4 )

reference depth	1290 m
<b>reference pressure</b>	12911 KPa
<b>water oil contact</b>	1365 m

**Table 4-8 Initial Conditions of Reservoir**

#### 4. Surfactant data

<b>Table 4-9: data.</b>		<b>Surfactant</b>
<b>Weight % surfactant</b>	<b>Interfacial tension, (dyne/cm)</b>	
<b>0</b>	18.2	
<b>0.05</b>	0.5	adsorption
<b>0.1</b>	0.028	laboratory
<b>0.2</b>	0.028	0.2494
<b>0.4</b>	0.0057	
<b>0.6</b>	0.00121	
<b>0.8</b>	0.00037	
<b>1</b>	0.5	

**Table 4-10:**

**adsorption**

**Surfactant**

### 4.3 Result and discussion

Comparison between primary recovery and water flooding and surfactant was made, to identify the extent of production increment, which justifies the use of this EOR method as a good option for recovery increase.

For this purpose the software was run three times, first run was used to simulate the primary recovery, in the second run the injector was introduced to simulate the case of water flooding, in the third run surfactant was introduced and injected with water with a

concentration of (0.01 mole fraction), the duration of each case was set equal to 15 years starting from Jan 2005 to Jan 2020.

The simulations were run on a five spot model with 4 producers in the corners and 1 injector in the middle.

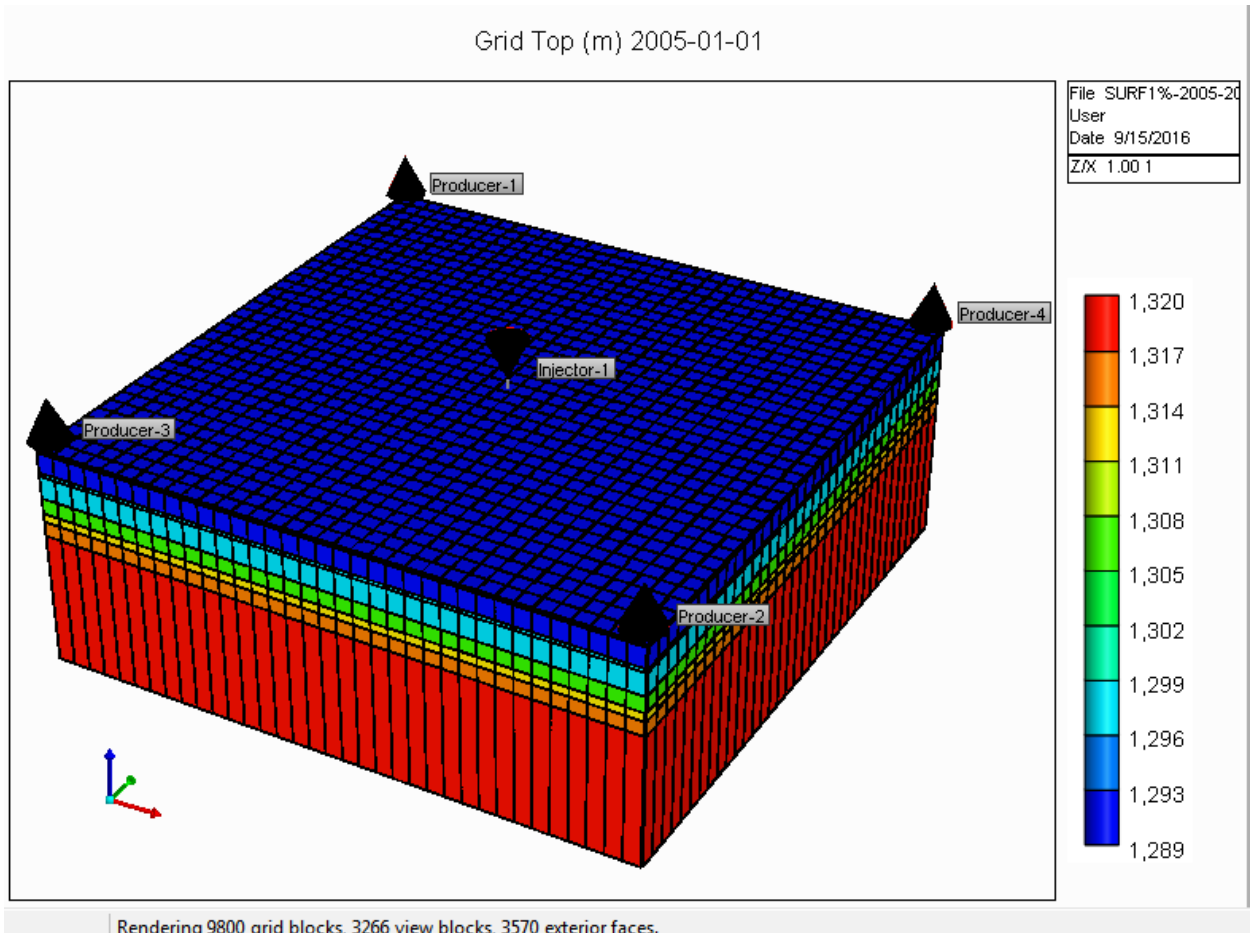

**Figure 4-29: Five spot model.**



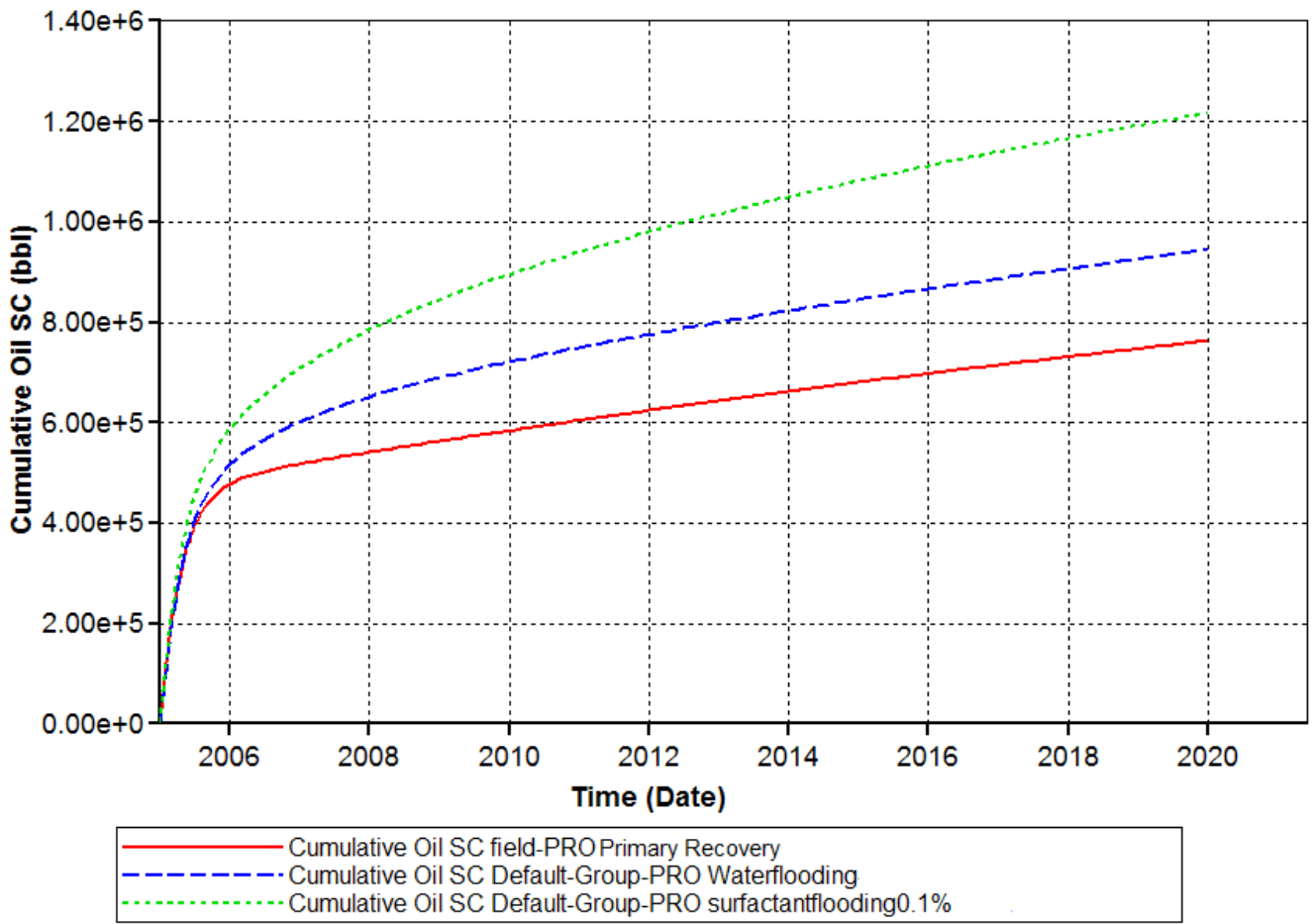

Figure 4-30: Cumulative oil SC (bbl) Vs. Time (Yrs).

Table 4-11:

Case	Cumulative oil Sc at the end of simulation date in (bbl)
Primary recovery	762,561
Waterflooding	944,154
Surfactant flooding	1,217,070

Cumulative oil SC for each recovery case.

Analyzing the figure above and table, it is clear that surfactant flooding has achieved a great increase in cumulative oil recovery over primary and waterflooding cases, which confirms the positive indicators obtained from the screening criteria performed in the previous chapter.

### 4.3.1 Surfactant concentrations

After we confirmed that surfactant flooding can increase recovery over that of water flooding (by 272,916 bbl), the objective now is to estimate the optimum surfactant concentration, for this purpose five concentrations were chosen to perform the sensitivity analysis, which are (0.20 – 0.15 – 0.10 – 0.05 – 0.01)mole fraction. The decision will be made based on two technical considerations which are, Cumulative oil obtained under each concentration, and the resulted water cut %.

Surfactant concentration (mole fraction)	Cumulative oil SC (bbl)	Cumulative water SC	Water cut %
0.20	1,223,870	8,309,010	95.94
0.15	1,221,350	8,299,560	95.94
0.10	1,217,070	8,292,360	95.93
0.05	1,211,900	8,284,770	95.93
0.01	1,203,510	8,283,000	95.93

**Table 4-12: Cumulative production for different concentrations.**

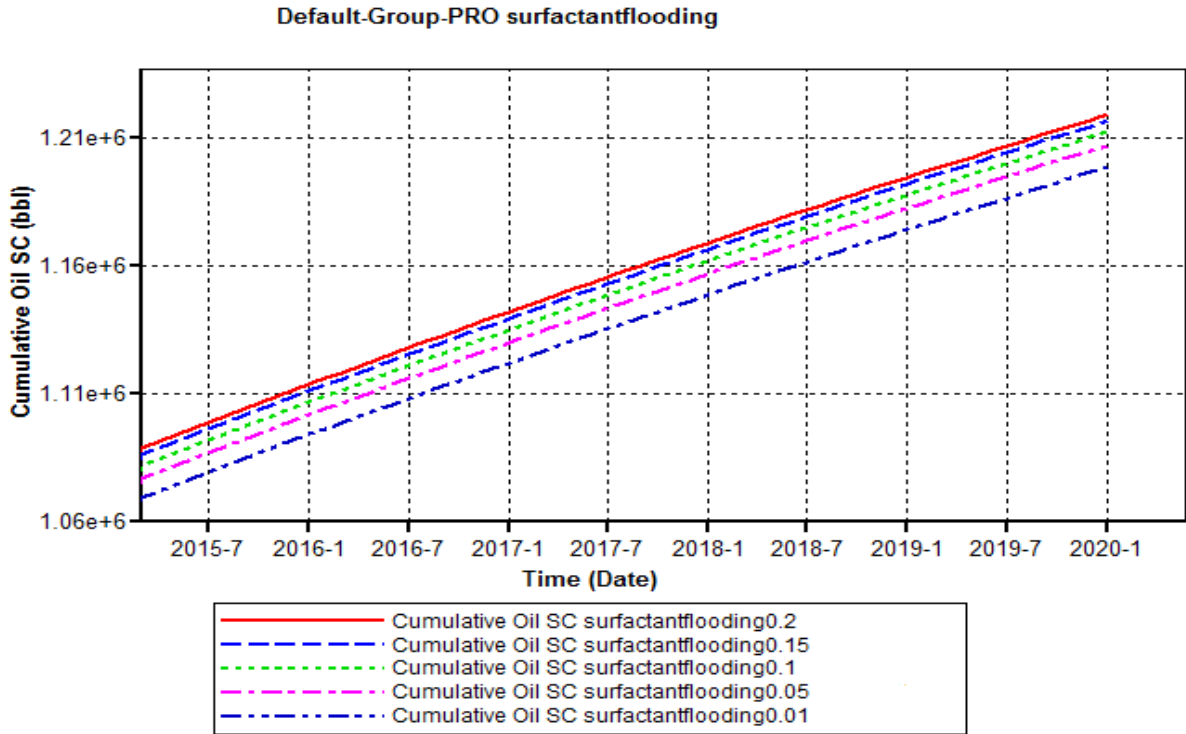

**Figure 4-31: Cumulative oil SC (bbl) Vs. Time (Yrs).**

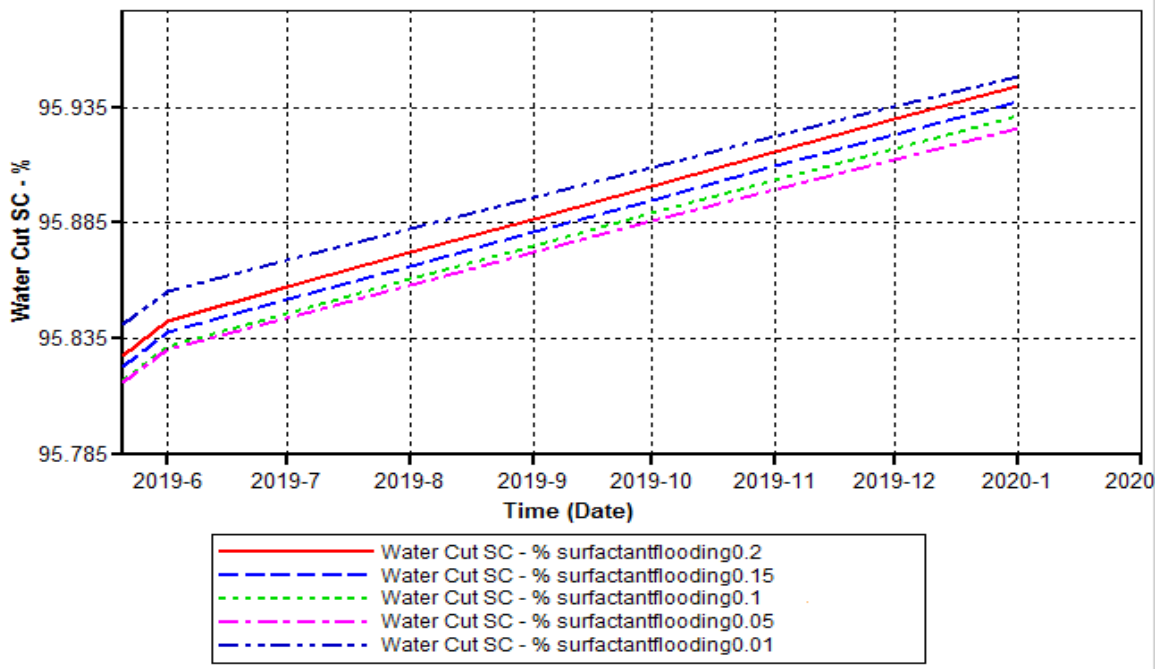

**Figure 4-32: water cut% Vs. Time (Yrs).**

By observing the above graphs and table we can see that all the surfactant concentration gives a close results specially in the case of water cut and , it is noticed that a surfactant concentration of 0.05 gives the minimum water cut and its cumulative oil increment is also close the highest value which achieved by surfactant concentration of 0.2, based on these observations and also considering the fact of cost of chemicals, a surfactant concentration of 0.05 can be considered the optimum concentration for this case study.

### 4.3.2 Injection rate

After determining the optimum surfactant concentration (0.05 in mole fraction), now we need to estimate the optimum injection rate for the injection of surfactant, for this objective 5 different injection rates were studied (250 m<sup>3</sup>/day – 200 m<sup>3</sup>/day - 150 m<sup>3</sup>/day - 100 m<sup>3</sup>/day – 50 m<sup>3</sup>/day) all of these injection rates were run with 0.05 surfactant concentrations. The results obtained are showed below:

injection rate (m <sup>3</sup> /day)	Cumulative oil SC (bbl)	Cumulative water SC (bb)	Water cut %
250	1,211,900	8,299,560	95.93
200	1,181,260	6,620,560	95.03
150	1,143,170	4,951,300	93.61
100	1,090,160	3,297,120	90.98
50	1,009,520	1,676,120	84.16

**Table 4-13: Cumulative production for different concentrations.**

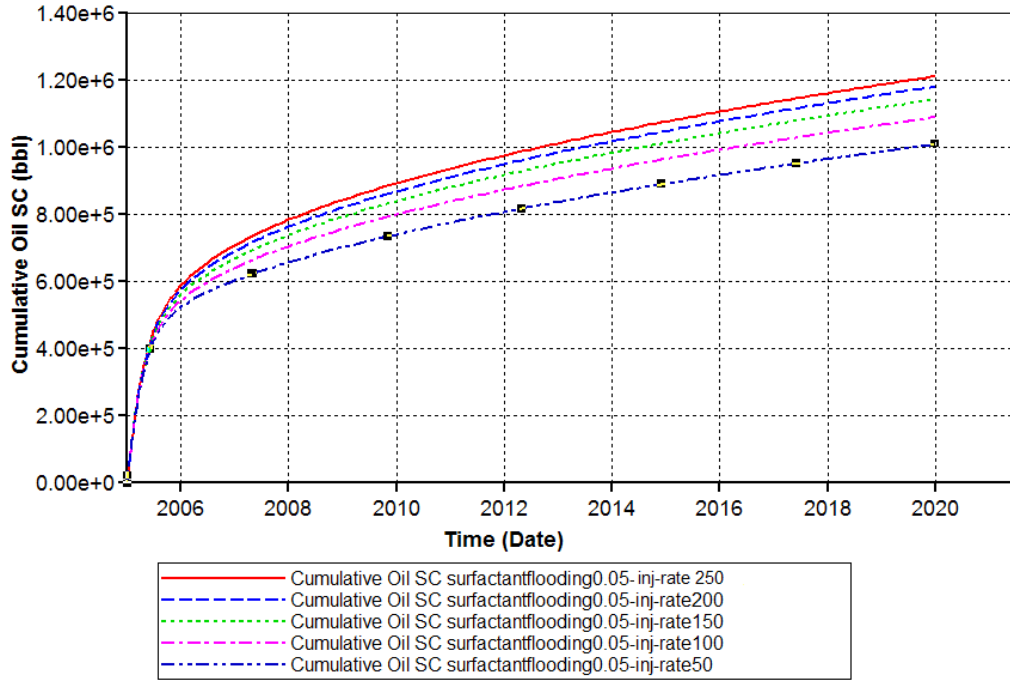

Figure 4-33: Cumulative oil SC (bbl) Vs. Time (Yrs).

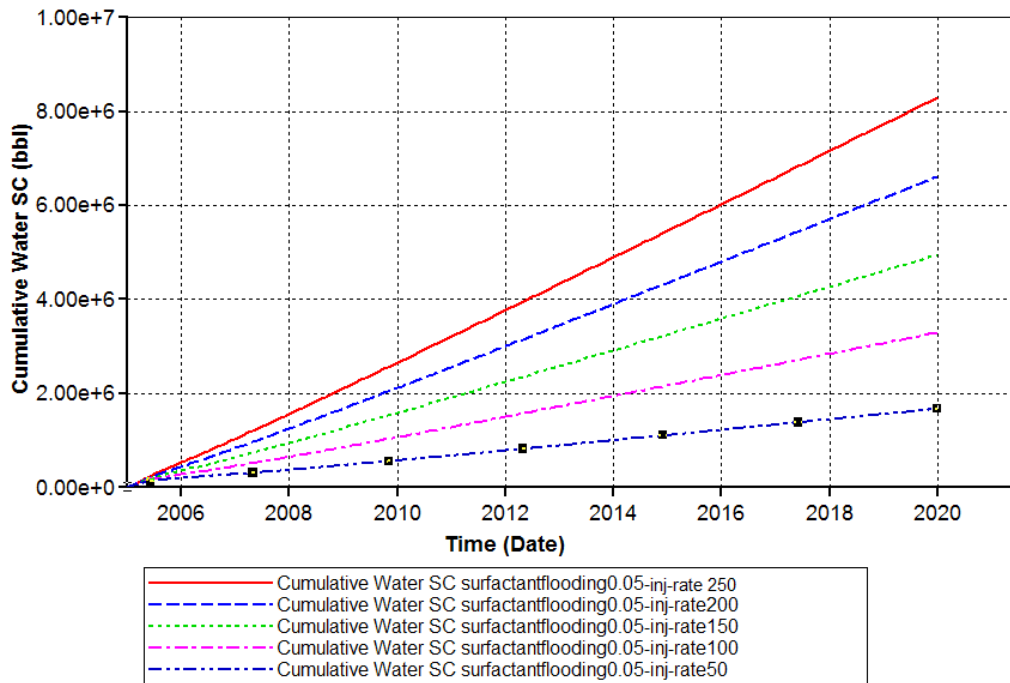
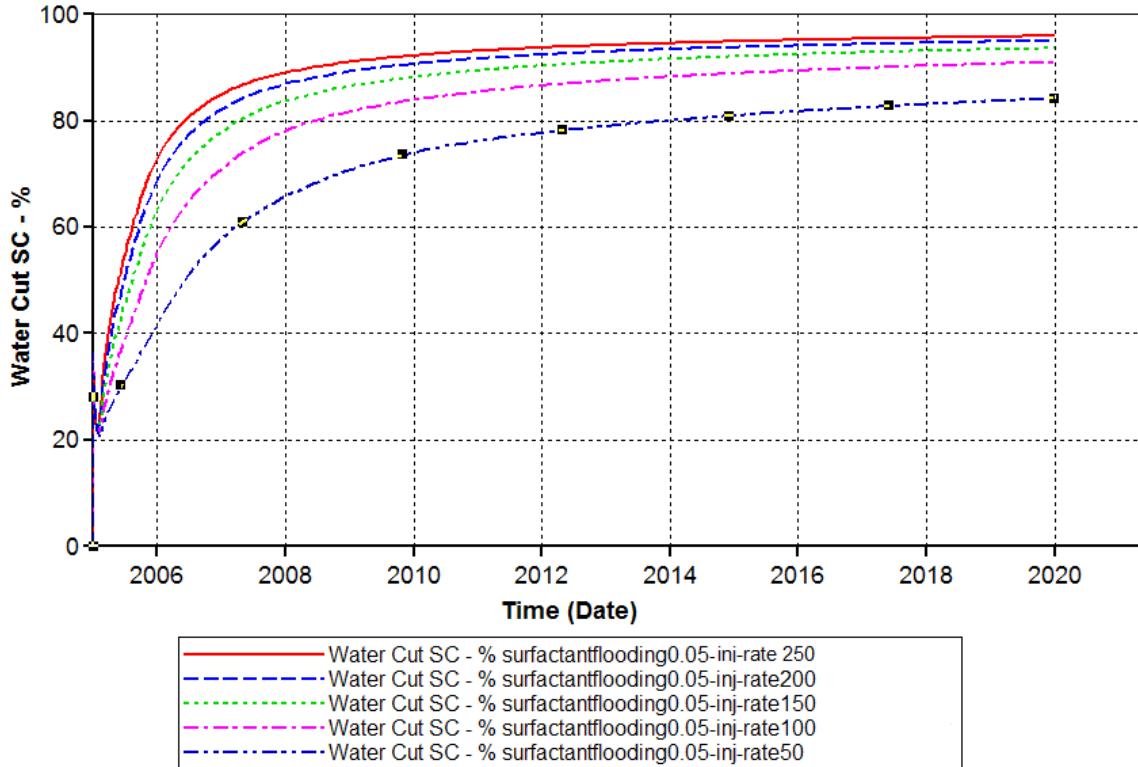

Figure 4-34: Cumulative water SC (bbl) Vs. Time (Yrs).



**Figure 4-35: water cut% Vs. Time (Yrs).**

From above graphs and table it can be seen that as injection rate increases the cumulative oil production increases but the cumulative water production also increases with increasing injection rate, so the choice must be made in balance between these two factors. An injection rate in the range of (200-100 m<sup>3</sup>/day) can be considered since it provides good levels of oil production though its water cut is high as well, the final decision must be made based on the economical analysis.

## **5 Chapter 5: Conclusions & Recommendations**

### **5.1 Conclusions**

- Screening criteria for Bamboo main field showed a positive indicator in regard to surfactant flooding.
- As surfactant concentration is increased the cumulative oil produced also increases but the increase becomes insignificant after a certain concentrations.
- Increasing Surfactant concentration will increase the cost of process.
- Surfactant flooding can increase cumulative oil production in Bamboo Main Oil Field by (28.9 %) in compare with the base case of water flooding.
- The optimum surfactant concentration was found to be 5%.
- The optimum injection rate was found to be in the range of 200-100 (m<sup>3</sup>/day).

### **5.2 Recommendations**

- One of the negatives surfactant flooding is the increased water production, a study of the use of polymer with surfactant in this field is much recommended.
- It's recommended to do study on the effect of the volume of surfactant slug, and different injection techniques.
- It's recommended to apply this work on the actual field model.
- An economic analysis should be made to evaluate the feasibility of the project in profitable terms, since this research evaluate the process on technical point of view.

## **6 References**

1. Ahmed, T., (2010) Reservoir engineering handbook. 4 edition. Huston : Gulf



Professional Publishing.

2. Eldias Anjar Perdana et.all (2011) Case Study : Cyclic Steam Stimulation in Sihapas Formation. in SPE Asia Pacific Oil and Gas Conference and Exhibition, 20-22 September, Jakarta, Indonesia : SPE 147811.
3. Green, D.W., and Willhite, G.P. (1998) Enhanced Oil Recovery. Texas: Society of Petroleum Engineers.
4. Husham and ELamin (2014) Design and Implementation of Enhanced Oil Recovery Cyclic Steam Stimulation (CSS) Program in Bamboo West Field-Sudan, Case Study. in SPE International Heavy Oil Conference and Exhibition, 8-10 December, Mangaf, Kuwait: SPE 172892.
5. Interpretation Report of High Temperature Testing of BB-22-For OEPA
6. Jelmert,T,N,L,S,C,O,M .et.all (2010) Comparative Study of Different EOR Methods. Norne Village : NTNU
7. M.L. Mao (2000) Evaluation of Cyclic Steam Injectors in China . in SPE Asia Pacific Conference on Integrated Modelling for Asset Management, 25-26 April, Yokohama, Japan : SPE-59463-MS.
8. Raj Deo et.all (2011) Successful Cyclic Steam Stimulation Pilot in Heavy Oilfield of Sudan . in SPE Enhanced Oil Recovery Conference, 19-21 July, Kuala Lumpur, Malaysia : SPE-144638-MS.
9. Romero-Zerón, Laura (ed.) (2012) Introduction to Enhanced Oil Recovery (EOR) Processes and Bioremediation of Oil-Contaminated Sites. Croatia : InTech.

10. S Thomas, (2008) Enhanced Oil Recovery – An Overview, Oil & Gas Science and Technology – Rev. IFP, Vol. No. 1.

11. Suranto AM, et.all (2014) Smart Completion Design for Managing Steam Injection in CSS Process . in SPE Saudi Arabia Section Technical Symposium and Exhibition, 21-24 April, Al-Khobar, Saudi Arabia : SPE 172212.