

بسم الله الرحمن الرحيم

Sudan University of Science & Technology

College of Graduate studies

Department of Physics

**Measurements of Radiation Doses of Natural
Radioactive Material in Oil fields at West Kourdofan**

قياس الجرعات الإشعاعية للمواد المشعة الطبيعية في حقول النفط في غرب
كردفان

By

Abdelmoniem Omer Khalid Abu-baker

**A thesis Submitted for the fulfillment requirements for
degree of master in Physics**

Supervisor:

Dr. Ahmed El-Hassan Elfaki (SUST)

December 2016

الآية

قال تعالى:

﴿ أَقْرَأْ بِاسْمِ رَبِّكَ الَّذِي خَلَقَ ﴿١﴾ خَلَقَ الْإِنْسَانَ مِنْ عَلَقٍ ﴿٢﴾ أَقْرَأْ وَرَبُّكَ الْأَكْرَمُ

﴿٣﴾ الَّذِي عَلَّمَ بِالْقَلَمِ ﴿٤﴾ عَلَّمَ الْإِنْسَانَ مَا لَمْ يَعْلَمْ ﴿٥﴾ ﴾

صدق الله العظيم

سورة العلق الآيات (1-5)

Dedication

To my dear family

Acknowledgments

In the name of God, most Gracious, most Merciful. First and foremost I thank Allah (Subhana Wa Taala) for endowing me with health and knowledge to complete this work. And since our prophet “Mohammed” peace be upon him say in his wise quote “He does not thank Allah, who does not thank people”.

The success in carrying out this work would not have been possible without generous contributions and support provided by many people.

I would like to thank my supervisor Dr. Ahmed Elhassan Elfaki for his guidance and patience that helped me throughout my research and writing of the thesis.

Also I would thanks general secretary of Ministry of Oil and Gas, Exploration Department and Central Petroleum Laboratories for their permission of taking samples from different locations and their permission of publication my research paper.

Many thanks to Ministry of Oil and Gas representatives in Heglig oil field to inform different departments to facilitate my mission.

Special thanks to GNPOC HSE department to their encouragements and support throughout the research.

Many thank to Survey department for their help. A lot of thank to CPF, Neem FPF, Diffra FPF and bamboo FPF Supervisors and foremen for their help during taking samples.

Many thank to Dr, Rahmtallah GNPOC Lab Supervisor and Mr. Badr Eldeen for their information and encouragements.

Special thanks to Sudan Atomic Energy Commission – Radiation Safety Department for their help in analysing samples.

I would like to thank Dr. Nasser Eldeen and Mr. Farah Saboon for their help of gathering information about NORM.

Many thank to my colleagues in Yarmouk Industrial Services Company, for their help and support.

Also special thanks to my family and friends for their help and encouragements.

Abstract

Scale, sludge and sand samples were collected and analysed using thallium activated sodium iodide NaI(Tl) spectrometer to determine type, activity concentration, absorbed dose rate and annual effective dose of naturally occurring radioactive material (NORM) of samples collected from oil fields at West Kourdofan state.

Scale radionuclides was found to be, ^{238}U , ^{232}Th and ^{40}K at concentrations ranged from (4106.9 - 358.05) Bq/Kg, (2736.7 - 375.88) Bq/Kg and (9294 - 16.07) Bq/Kg respectively. Concentrations in sludge was ranged from (655.36 - 23.3) Bq/Kg for ^{238}U , (396.34 - 16.19) Bq/Kg for ^{232}Th and (353.52 - 16.07) Bq/kg for ^{40}K . Concentrations in sand for ^{238}U was ranged from (2807.36 - 13.89) Bq/Kg, for ^{232}Th was ranged from (3466.24 - 14.6) Bq/Kg and for ^{40}K ranged from (614.89 - 16.06) Bq/kg.

Absorbed dose rate of scale samples ranged from (3692.01 - 398.03) nGy/h, sludge samples ranged from (542.84 - 30.49) nGy/h, sand samples ranged from (3395.25 - 23.42) nGy/h.

Annual effective dose of scale samples was ranged from (4.53 - 0.49) mSv/y, sludge samples was ranged from (0.7 - 0.08) mSv/y. sand samples was ranged from (4.16 - 0.02) mSv/y.

الخلاصة

عينات من Scale و Sand و Sludge تم جمعها وتحليلها باستخدام مطياف غاما (Na(Tl) وذلك لتحديد نوع وتركيز المواد المشعة طبيعية المنشأ وكذلك تحديد معدل الجرعة الممتصة والجرعة المكافئة السنوية من هذه العينات التي تم جمعها من حقول نفط في ولاية غرب كردفان.

النويدات المشعة التي وجدت في Scale هي اليورانيوم-238 والثوريوم-232 والبوتاسيوم-40 بتراكيز تتراوح بين (358.05-4106.9) Bq/Kg ، (375.88-2736.7) Bq/Kg ، (9294-16.07) Bq/Kg على التوالي. تراكيز النويدات المشعة التي وجدت في Sludge يتراوح بين (23.3-655.36) Bq/Kg لنوية اليورانيوم-238 ، (16.19-396.34) Bq/Kg لنوية الثوريوم-232 (16.07-353.52) Bq/Kg لنوية البوتاسيوم-40. التراكيز في Sand المرافق للنفط وجدت لليورانيوم-238 تتراوح بين (13.89-2807.36) Bq/Kg ، للثوريوم-232 وجد أنها تتراوح بين (14.6-3466.24) Bq/Kg ، وللبوتاسيوم-40 وجد أنها تتراوح بين (16.06-614.89) Bq/Kg.

معدل الجرعة الممتصة من Scale تتراوح بين (398.03-3692.01) nGy/h . ومن Sludge تتراوح بين (30.49-542.84) nGy/h . ومن Sand تتراوح بين (23.42-3395.25) nGy/h.

الجرعة السنوية الكافئة من Scale تتراوح بين (0.49-4.53) mSv/y . ومن Sludge تتراوح بين (0.08-0.7) mSv/y . ومن Sand تتراوح بين (0.02-4.16) mSv/y .

Contents

الإيــــة	vii
Dedication	vii
Acknowledgments	vii
Abstract	vii
الخلاصة	vii
Contents	vii
List of Figures	vii
List of tables	vii
Chapter One	1
Introduction	2
1-1 Origin of petroleum	2
1.2 History of oil in Sudan	2
1-3 A brief history of GNPOC pipeline & Production	3
1.4 Norm definition and hazards	4
1-5 NORM & TENORM	4
1-6 Research Problem	5
1-7 Objectives of the research	6
1-8 Research methodology	6
1-9 Literature Review	7
1-10 limitation of the research and future work	13
1-11 Outline of the thesis	13
Chapter Two	15
Radiation, NORM In Oil And Gas Industry And Radiation Detector	16
2.1 Radiation & Nuclear Structure	16
2.2 Radioactivity and radiation	16
2.3 Radioactive decay	17
2.4 Modes of radioactive decay	18
2.4.1 Alpha Particles decay	18
2.4.2 Negative beta particle (β^-) decay	20

2.4.3 Positive beta particle (β^+) decay	22
2.4.4 Gamma Emission	22
2.4.5 Internal conversion	23
2.4.6 Electron Capture	23
2.5 Interaction of Gamma radiation with matter	24
2.5.1 Photoelectric Absorption	25
2.5.2 Compton scattering	25
2.5.3 Pair production	26
2.6 Law of Radioactive decay	27
2.7 Growth of activity from decay of a parent	29
2.7.1 Transient equilibrium – $t_{1/2}$ parent > $t_{1/2}$ daughter	30
2.7.2 Secular equilibrium – $t_{1/2}$ parent \gg $t_{1/2}$ daughter	31
2.7.3 No equilibrium – $t_{1/2}$ parent < $t_{1/2}$ daughter	32
2.8 Radioactive decay series	32
2.9 Natural decay series	33
2.9.1 Primordial Radionuclides	34
2.9.2 Decay Chains	35
2-10 NORM in oil and gas industry	37
2-10-1 Brief History of Norm in oil and gas fields	37
2-10-2 Origin of Norm in oil and gas fields	37
2-10-3 Radionuclides concentrations in oil and gas industry.	39
2-10-3-1 Norm in scale.....	40
2-10-3-2 Norm in sludge	41
2-10-3-3 Norm in sand	42
2-10-4 Norm hazards and precautions	42
2-10-4-1 External exposure	43
2-10-4-2 Internal exposure	44
2-10-5 Doses Limits	45
2-11 Radiation detectors	46
2-11-1 Principle of detection	46
2-11-2 Detector resolution and efficiency	46
2-11-3 Type of detectors	46
2-11-3-1 Gas-Filled Detectors	47

2-11-3-2 Semiconductor Detectors	47
2-11-3-3 Scintillation detectors	48
2.11.3.3.1 Basic Principles.....	48
2.11.3.3.2 Photomultiplier Tubes (PMT)	49
2.11.4 Efficiency and resolution of HPGe and NaI (TI) detectors	51
Chapter Three.....	52
Samples Preparation and Experimental Method.....	52
3-1 fields trips	53
3-2 Sampling and sample preparations	54
3-3 Experimental method	55
3-3-1 Marinelli beaker	55
3-3-2 calibration process	56
3-3-2-1 Energy calibration.....	56
3-3-2-1 Efficiency calibration	57
3-4 Sample measurements	58
3-5 Calculations	60
3-5-1 Activity concentration	60
3-5-2 Absorbed dose	60
3-5-3 Annual effective dose	61
Chapter Four	62
Result and discussion	63
4-1 Result	63
4-2 discussion	71
4-3 Conclusion	72
References	73
Appendix I	77
Appendix II	81
Appendix III	82
Appendix IV.....	83

List of Figures

Figure 1.1: Sudan oil and gas license blocks – (GNPOC blocks are 2 & 4)	3
Figure 2.1: Type of radiation and penetration	19
Figure 2.2: Photoelectric absorption process	25
Figure 2.3: Compton Scattered gamma photon	26
Figure 2.4: Pair production process	27
Figure 2.5: Interaction mechanisms of X and gamma-rays with matter	27
Figure 2.6: Exponential radioactive decay curve	29
Figure 2.7: Transient equilibrium	31
Figure 2.8: secular equilibrium	31
Figure 2.9: No equilibrium	32
Figure 2.10: decay scheme for ⁴⁰ K	35
Figure 2.11: Decay chains for the three main naturally occurring radioactive decay series	36
Figure 2.12: Origin of NORM in oil & gas industry	39
Figure 2-13: An abandoned pipeline due to heavy scale formation	41
Figure 2-14: A bulk of scale extracted during maintenance	41
Figure 2-15: Sludge inside heater treater	42
Figure 2-16: Sludge bit at big receiver	42
Figure 2.17: Key Components in a simple ionization chamber	46
Figure 2.18 Scintillation detector	50
Figure 3.1: Map showing Sampling areas	53
Figure 3-2: Marinelli Beaker	55
Figure 3-3: Standard calibration source MW652	56
Figure 3-4: Energy calibration curve	57
Figure 3-5 Efficiency Calibration curve	58
Figure 3-6: NaI(Tl) detector	59
Figure 3-7: Sample S-32 Spectrum	59
Figure 4-1: Comparison between Annual Effective Dose (AED) result from sample and AED limits for members of the public/Incidentally exposed workers and occupationally exposed workers – (Neem Field)	65

Figure 4-2: Comparison between Annual Effective Dose (AED) result from samples and AED limits for members of the public/Incidentally exposed workers and occupationally exposed workers – (Diffra Field)	67
Figure 4-3: Comparison between Annual Effective Dose (AED) result from samples and AED limits for members of the public/Incidentally exposed workers and occupationally exposed workers – (Bamboo Field)	68
Figure 4-4: Comparison between Annual Effective Dose (AED) result from samples and AED limits for members of the public/Incidentally exposed workers and occupationally exposed worker – (Heglig Field).....	70
Figure 4-5: Comparison of average activity concentration of radionuclides found in Scale, sludge and sand	71
Figure I-1: CPF Sample points – Heglig	77
Figure I-2: Heglig -56 Sample points – Heglig	77
Figure I-3: Neem FPF Sample points – Neem	78
Figure I-4: Neem - 03 Sample points – Neem	78
Figure I-5: Diffra FPF Sample points – Diffra	79
Figure I-6: WE-01 Sample points – Diffra	79
Figure I-7: HA-01 Sample points – Diffra	80
Figure I-8: Bamboo FPF Sample points	80
A bulk of scale extracted during Routine maintenance	83
Abandoned pipeline due to heavy scale formation	83
Sludge inside heater treater	83
Sand extracted from vessel and put in drums in special closed area	83

List of Tables

Table 4-1: Activity concentration of ^{238}U , ^{226}Ra , ^{232}Th and ^{228}Ra in hard scales.....	40
Table 4-2: Activity concentration of ^{238}U , ^{226}Ra , ^{232}Th and ^{228}Ra in hard scales.....	41
Table 3-1: Efficiency for calibration source	57
Table 5-2: Neem Field samples activity concentration, absorbed dose rate and annual effective dose results	64
Table 5-3: Diffra Field samples activity concentration, absorbed dose rate and annual effective dose results.....	66
Table 5-4: Bamboo Field samples activity concentration, absorbed dose rate and annual effective dose results.....	66
Table 5-5: Heglig Field samples activity concentration, absorbed dose and annual effective dose results.....	69
Sample Points Coordinates	81
Kind of samples	82

CHAPTER I

INTRODUCTION

1-1 Origin of petroleum

Two schools of thoughts exist in regards to the origin of petroleum: A western school suggests that its origin is biogenic resulting from biological matter and stored in sedimentary basins while a Russian-Ukrainian school proposes that it is abiogenic or abiotic with the deep origin in the Earth's crust. The first theory implies a finite source of petroleum whereas the second theory suggests an almost unlimited one ^[1].

1.2 A brief history of oil in Sudan

Oil exploration in Sudan was first initiated in 1959 by Italy's Agip oil company in the Red Sea area. The first oil discovery in Sudan was made by Chevron in the south of Sudan in 1979, west of the Muglad. Chevron suspended its operations in 1984 and entirely ended its 17 year long involvement in Sudan. In 1996 China National Petroleum Company (CNPC), Petronas (Malaysia), and Sudanpet (Sudan) with which it jointly formed the Greater Nile Petroleum Operating Company (GNPOC).

GNPOC made considerable discoveries, increasing the amount of proven reserves in Sudan. It also succeeded in the construction of the pipeline from the Heglig and Unity fields to Port Sudan on the Red Sea. In 1999 the pipeline became operational and carried the first Sudanese oil exports to Port Sudan ^[2].

1-3 A brief history of GNPOC pipeline & Production

In 1998 to 1999 GNPOC installed oil production and processing facilities for 5 oil fields in the Muglad Basin of South Sudan. More than 15,000 KM pipeline was also constructed from the fields to Bashair terminal in the Red Sea Fig. (1.1).

Production was estimated at 150,000 bpd and could grow to 300,000 bpd over the medium term. First shipment was transported in the pipeline in June 1999. Parts of crude oil are distributed to the El Obied refinery and the Khartoum Refinery for domestic consumption. The remaining oil is exported [3].

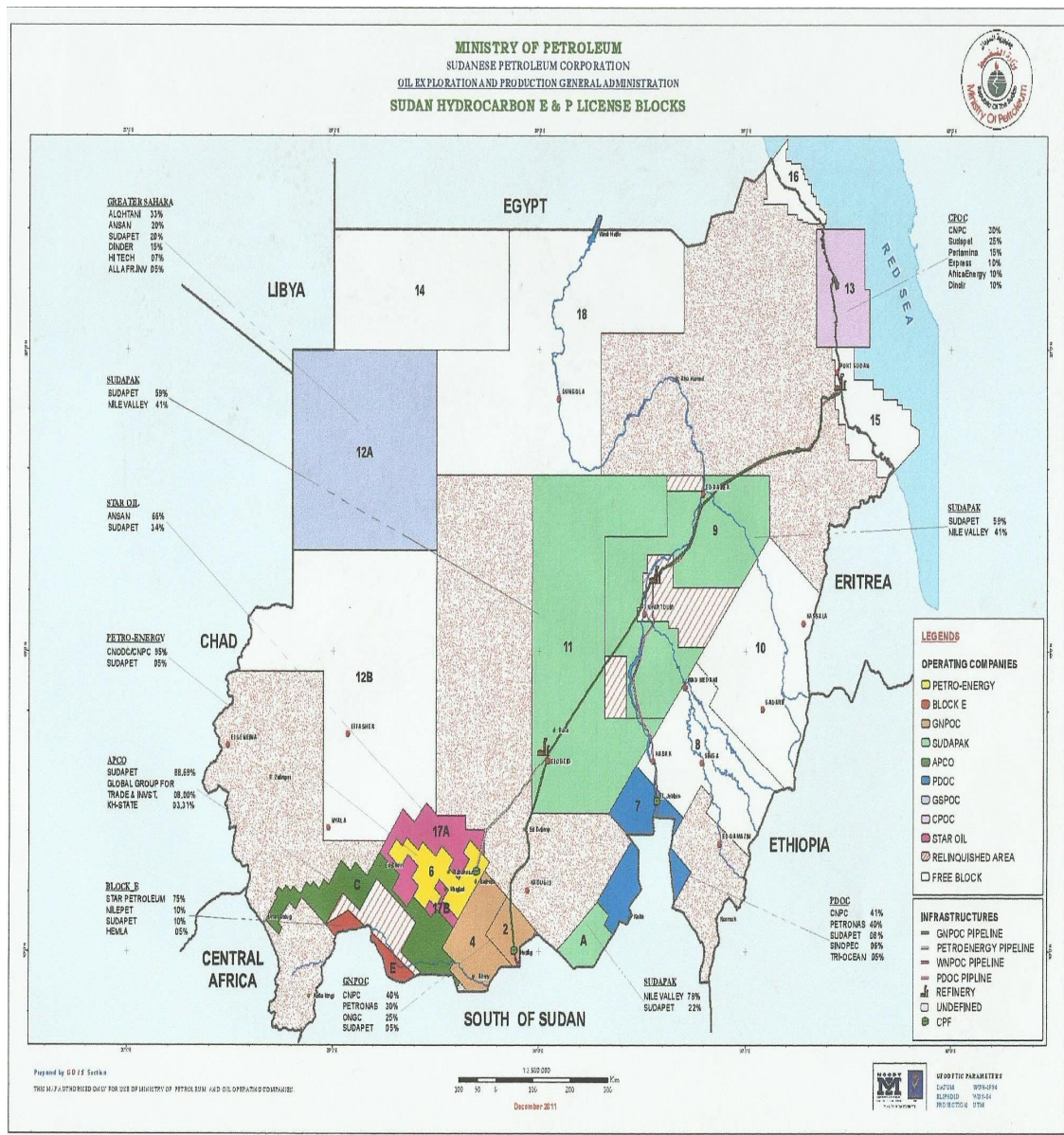

Figure 1.1: Sudan Oil and Gas License Blocks – (GNPOC Blocks are 2 & 4)

1.4 Norm definition and hazards

NORM is an acronym for ‘naturally occurring radioactive material’^[4]. This term used to describe materials that contain radionuclides that exist in the natural environment. Long-lived radioactive elements of interest include uranium, thorium and potassium, and any of their radioactive decay products, such as radium and radon. These elements have always been present in the earth’s crust and within the tissues of all living species^[5]. As a result of the widespread presence, a certain amount of radioactivity is always present in substances. In most naturally occurring radioactive material (NORM), several or all radioactive isotopes of the three natural decay series (^{238}U , ^{235}U , ^{232}Th) and ^{40}K are present in small concentration in the natural matrix. In the original ores, or formation in the case of the oil and gas industry, the radionuclides within a decay series are more or less in radiological equilibrium. By industrial physical, chemical and thermal process the natural equilibrium of the radionuclides can be disturbed resulting in either an enrichment or decrement of some radionuclides compared to the original matrix.

The presence of NORM can lead to radiation doses that are not insignificant from the radiation protection of view. Individual doses of workers exposed to NORM in industry can be significant. When the operator of a practice, or the regulatory authority, is not aware of the problems associated with enhanced levels of NORM in raw materials, products or residues and when no protective action are taken the doses to workers may even exceed the occupational dose limit^[6].

1-5 NORM & TENORM

Reports of the occurrence of significant concentrations of radionuclides of natural origin in the oil and gas industry go back to 1904. And it seemed that the term NORM was first coined by this industry in the

late 1980s when referring to the radium-rich scale deposited inside well tubular, surface piping, vessels, pumps and other production and process equipment. Since then the term has become widely adopted beyond the oil and gas industry and now tends to be associated with almost any type of mineral or mineral processing activity where the presence of radionuclides of natural origin is of interest.

The term TENORM (Technologically Enhanced Naturally Occurring Radioactive Material), implies that the materials of concern are limited to those in which the radionuclides have become concentrated as a result of industrial process. This is often the case, but not always. Materials in their natural state are in principle no less important to consider than materials with activity concentrations enhanced by some form of processing.

The approach adopted by the IAEA for the purpose of international radiation protection standards is to use the term NORM, regardless of the origin of the material. NORM is then a particular form of radioactive material, where the radioactivity is associated with radionuclides of natural origin. This approach solve the problem of how to single out only those materials of radiological concern, while avoiding the need for any additional and potentially misleading terms such as TENORM, the use of which is therefore discourage ^[7].

1-6 Research Problem

Natural Occurring Radioactive Materials (NORMs) can contaminate environment and pose a risk to human health.

It has been established that (NORM) may accumulate at various locations along the oil production process. Components such as wellheads, vessels, tanks and other processing equipments can become NORM contaminated, and NORM can accumulate in the form of sludge, scale,

sand and other waste media. This can create a potential radiation hazard to workers, general public and the environment if certain controls are not established.

1-7 Objectives of the research

Depending on the research problem, this research tries to identify:

- Type of radionuclides present.
- Concentration of radionuclides.
- Absorbed dose rate.
- Annual effective dose.

Of NORM in oil fields at West Kourdofan State which operate by Greater Nile Petroleum Operating Company (GNPOC) which include Heglig, Bamboo, Diffra and Neem oil fields. The results of this research are expected to provide useful data to policy makers, considering the environmental impacts of NORMS, as well as workers health risks in the oil & Gas Industries. The findings will provide information regarding the types, concentration, absorbed dose and annual effective dose of NORMS in the collected samples and hence optimizing the radiation protection precautions at the production site also this can help in putting management strategy to deal with NORM including handling, transporting and management of NORM waste.

1-8 Research methodology

Fields trips were carried out from Nov.-2014 to Oct.-2015 to four oil fields at west Kourdofan state which operates by Grater Nile Operating Company “GNPOC”. The trips include “Heglig, Neem, Diffra and Bamboo oil fields”, where Heglig & Bamboo were located in block “2”, and Neem & Diffra in block “4”.

The aim of these trips was to collect samples for analysis and so to determined type, concentration and associated doses of Natural Occurrence Radioactive material in these samples.

The samples have been characterized using gamma spectroscopy through using of thallium activated sodium iodide NaI (TI) spectrometer - Sudan Atomic Energy Commission.

The samples was prepared, then placed into Marinelli beakers and weighted using a digital weighting balance and stored for more than four weeks before counting, in order to allow of secular equilibrium of parent with its short-lived progeny to take place. Each sample was placed onto NaI (TI) detector and measured for at least three hours.

Calibration process carried out for gamma spectroscopy using standard calibration source MW652 as reference source which recommended by International Atomic Energy Agency including source ^{137}Cs and ^{60}Co . Each sample was placed onto the detector and measured for at least three hours. The ^{238}U concentration was determined from the average concentrations of the ^{214}Bi (609 Kev), ^{214}Pb (352 keV) and ^{214}Pb (295 keV) decay products. ^{232}Th concentration was determined from the concentrations of the ^{212}Pb (238 keV). ^{40}K (1460 kev) concentration was determined directly. Concentrations were detected after counts per seconds have been evaluated.

The results of samples analysis indicate existence of elevated radionuclide concentration of samples collected from block “4” than samples collected from block “2”.

1-9 Literature Review

There were many researches and papers published concern radionuclides concentration in Sudan soil, rocks, Nile River and red sea

coast. And there are studies, papers and researches published in other countries concern radionuclides concentration in oil and gas industry.

The following are three studies carried out in other countries and two local studies.

- Ahmed Shawki Habib (PhD degree in physics – University of Surrey Nov-2012) (**Measurement of NORM in Non-uniform Scale Samples from Libyan Oil Industry Using Gamma Spectroscopy and Monte Carlo Technique**).

That research aims to explore the extent of NORM in oil pipe-scales in different Libyan oil fields and to determine the radionuclides present and their activities. Samples have been characterized using gamma spectroscopy through use of HPGe spectrometer. MCNPX, a Monte Carlo simulation code, is being used to simulate the spectrometer and the scale samples in order to obtain the system's absolute efficiency and then to calculate sample specific activities.

In that study 27 scale samples was collected from different Libyan oil fields that had different production date. Twelve Samples that produced the highest dose rates were counted to give a representation of the higher limit of sample activities and to allow counting for short periods of time. Due to the large variety of sample geometries, ten samples with similar shapes were selected to be investigated in this study. These scale samples collected from rejected pipes, valves, and wellheads. Each sample was held in contact with end cap of the detector and central to the detector face using a lab support in its original plastic packaging. (^{226}Ra varied from (23 – 221) Bq/g. ^{238}U ranged from (23 – 210) Bq/g and those of ^{232}Th from (0.3 – 81) Bq/g. All samples were obtained from the oldest oil producing area in Libya (1960) and this may explain the relatively elevated activities in all

samples, possibly from the use of injected ground water to generate artificial lift.

- **Comments on that research:**

- 1- Only scale samples were collected and analysed.
- 2- Limited number of samples.
- 3- Scale samples collected only from rejected pipes, valves, and wellheads.
- 4- All samples were obtained from the oldest oil producing area in Libya.

- **Limitation of that research:**

- 1- Inability to prepare the samples in a standard shape and composition because the samples were analysed at the university of surrey environmental laboratory, Surrey radiation safety procedures do not allow for processing of materials containing alpha emitters and hence samples cannot be unpacked from their original bags, ground and homogenized, or even transferred to more uniformly shaped containers. So samples was not put in Marinelli beaker, instead sample was held in contact with end cap of the detector and central to the detector face using a lab support in its original plastic packaging.
 - 2- Each sample has different dimensions, and this case has necessitated a separate model to be built and tested for each sample. This consumed a considerable part of the time devoted for the research work.
- From previous research it obvious that some scale samples in oil and gas industry had elevated radionuclide activities, so scale was one of the samples collected in my research, but since there are other oil containments like sludge and sand which may contain elevated

radionuclide activities, number of these samples was also collected and analysed. These samples were collected from different facilities and equipments during running or periodic maintenance, not only from rejected pipes, valves, and wellheads, because facilities and equipments are occupied and in contact with worker most of time during workers shift. Also samples were collected at different times (Nov. 2014 – Oct. 2015).

- M. S. Al-Masri, H. Suman - **Atomic Energy Commission of Syria (AECS). (NORM waste management in the oil and gas industry: the Syrian experience).**

That paper describes the Syrian experience with respect to Naturally Occurring Radioactive Materials (NORM) waste produced by the Syrian oil industry. Three main categories of NORM waste were identified, hard scales, Sludge and soil.

All soil and scale samples were dried in the oven for 48 hours at 105 °C. The samples were then grinded, and about 40g of each sample was filled in a special counting container and stored for two weeks for counting. Activities in the collected samples were then determined by gamma spectrometry using high resolution HPGe detectors Sludge samples were stirred manually by a glass rod and filled in 0.5 liter plastic for counting.

- **Results:**

NORM concentrations in some hard scales are ranged from (27 - 115) Bq/g for ^{224}Ra , (147 - 1050) Bq/g for ^{226}Ra and (43 - 181) Bq/g for ^{228}Ra . NORM concentrations in some sludge samples are ranged from (385-562) Bq/g for ^{224}Ra , from (470- 1000) Bq/g for ^{226}Ra and from (359-660) Bq/g for ^{228}Ra .

NORM concentrations in some soil samples ranged from (2.4 – 77) Bq/g for ^{226}Ra .

- **Comments on this study:**

NORM in Syrian oilfields has been recognized since 1987, so there are some regulations control cleanup and disposals of wastes which helped in collection samples.

- T. PAVLENKO, M. AKSYONOV, O. GERMAN, M. FRIZIUK, E. FEDORENKO, A. MIKHAJLENKO (**NORM assessment at gas and oil fields in Ukraine**).

The study gives an overview of the naturally occurring radioactive materials (NORM) content assessment in soil and sludge samples from the oil and gas fields in Ukraine. That research work includes measurements of gamma radiation, exposure rates from the industrial facilities as well as gamma spectrometric measurements of soil and sludge samples.

Soil samples were taken close to the wells and tanking stations as well as at the production sites. Sludge samples were taken directly from tanks and storage sites. The samples were measured for the radionuclide content estimation. For this purpose, the gamma spectrometric method was applied utilizing high resolution gamma spectrometer ORTEC (USA).

Prior to the measurements all samples were dried and weighted. The obtained spectra were used to estimate specific activities of ^{226}Ra , ^{232}Th and ^{40}K .

The analysis of the measurements of radionuclide specific activity in the sludge samples demonstrated higher NORM activities than in the ground samples from the industrial site. It was established that ^{226}Ra and ^{232}Th are major contributors to the radioactive pollution.

Concentration of NORM in the soil samples from other points at the industrial sites did not exceed the background values, with the only exemption at the sorting station.

- **Result:**

Average specific activity of NORM in soil and sludge samples from Rybalskoe oil field was found to be for soil samples ranged from (8 – 996) Bq/Kg for ^{226}Ra , from (7 – 306) for ^{232}Th and from (< 5 to 753) for ^{40}K . For sludge samples the highest reading was 29689 Bq/Kg for ^{226}Ra , 4832 Bq/Kg for ^{232}Th and < 5 for ^{40}K .

- **Comments on this study:**

- 1- Limited number of samples.
- 2- Samples were only soil and sludge.
- 3- Specific activity in the sludge samples demonstrated higher NORM activities than in soil.

- Adam Khatir Sam, M. M. O. Ahamed, F. El Khangi, P. Roos - Sudan Atomic Energy Commission – 2000 (**plutonium Isotopes in sediments from the Sudanese coast of the Red Sea**).

That paper presents the activity concentrations of Pu isotopes in surface marine sediments collected from the Sudanese coast of the Red Sea.

- **Result**

The concentration ranges were determined: ^{238}Pu , 4.7-28.6 mBq/kg; $^{239+240}\text{Pu}$, 53-343 mBq/kg dry weight.

- Alshfia Hashiem Osman - April 2015 (**Investigation of Uranium-238, Potassium -40 and Thorium-232 Level in Soil and Rock Samples from North and South of Kourdofan state (Western Sudan)**)

In that study 40 soil and rock samples were collected from locations (A,B,...G) from North and South of Kourdofan state.

- **Results**

The concentration of ^{238}U was found to be range (483.133-10.58)Bq/kg. Concentration of ^{232}Th was found to be (327.8-16.96)Bq/kg. Concentration of ^{40}K was found to be (684.41-34.47)Bq/kg for all locations.

- **Comments on this study:**

There were some high activity concentrations in soil and rocks from Kordofan State, so oil fields in this state well contain enhanced levels of natural radioactivity due to accumulation of these radionuclides as a result various industrial activities.

1-10 limitation of the research and future work

One should consider the limited number of samples, and samples randomly collection, so fields survey before sampling can carry out for future work. Also samples were analysed using NaI (TI) which had poor resolution, lead to miss some energies. HPGe Detectors which had good resolution can be used to identify radionuclides in future studies.

Further investigations are recommended to all Sudan oil fields. Drilling mud and produced water can be part of samples for future work.

1-11 Outline of the thesis

Chapter II covers radiation and radioactive decay, in addition to modes of radioactive decay, also it covers interaction of gamma radiation with matter and law of radioactive decay, it show radioactive and natural decay series. This chapter also discusses in brief history NORM in oil and gas industry and in more detail radionuclides concentrations in oil and gas industry. This chapter ends with principle of detection and type of detectors. Samples preparation, experimental method, samples

measurement and calculations are discussed in chapter III. Finally chapter IV provides result, discussion and conclusion.

CHAPTER II

RADIATION, NORM IN OIL AND GAS INDUSTRY AND RADIATION DETECTORS

2.1 Radiation & Nuclear Structure

Radiation is energy. It can come from unstable atoms or it can be produced by machines. Radiation travels from its source in the form of energy waves or energized particles.

There are actually two kinds of radiation, and one is more energetic than the other. It has so much energy it can knock electrons out of atoms, a process known as ionization. This ionizing radiation can affect the atoms in living things, so it poses a health risk by damaging tissue and DNA in genes. While there are other, less energetic, types of non ionizing radiation (including radio waves, microwaves and visible light) ^[8].

A nuclear species, or *nuclide*, is defined by N , the number of neutrons, and by Z , the number of protons (atomic number). The mass number A is the total number of nucleons, i.e. $A = N + Z$. Atom characterized by its nuclear constitution — its values of Z and A (or N) — is called a nuclide. A nucleus can alternatively be denoted as ${}^A_Z X$, where, X is the element symbol ^[9].

2.2 Radioactivity and radiation

Although many nuclides are stable, most are not. Stability is determined mainly by the balance between the number of neutrons “ N ” and protons “ Z ” a nuclide contains. Smaller stable nuclei have about equal numbers: larger stable nuclei have slightly more neutrons than protons. Nuclei with too many neutrons tend to transform themselves to a more stable structure by converting a neutron to a proton: this process, known as beta decay, results in the emission of a negatively charged electron called a beta particle. Nuclei with too many protons convert the excess protons to

neutrons in a different form of beta decay: they lose positive charge through the emission of a positron, which is a positively charged electron.

These transformations often leave the nucleus with excess energy that it loses as gamma rays — high energy photons, which are discrete parcels of energy without mass or charge. The spontaneous transformation of a nucleus is called *radioactivity*, and the excess energy emitted is a form of (ionizing) radiation. The act of transformation is termed decay and the nuclide that changes and emits radiation is called a *radionuclide*.

Some heavy nuclei decay by producing an alpha particle consisting of two protons and two neutrons. Identical with a nucleus of helium, the alpha particle is much heavier than the beta particle and carries two units of positive charge ^[10].

2.3 Radioactive decay

Radioactive decay is the process in which an unstable atom releases matter and/or energy during a transition to a more stable form. It may do so by releasing subatomic particles and energy, or by capturing an orbital electron into the nucleus and releasing energy. Atoms that are unstable are also known as radioactive atoms, or radionuclides. The original, radioactive atom is known as the parent. The new nucleus (after decay) is known as the daughter.

The nucleus of an atom exists because the attractive force (strong nuclear force) operating among protons and neutrons balances the Coulomb force pushing the nucleus apart. Some combinations of neutrons and protons are very successful in holding the nucleus together. These nuclides remain intact indefinitely and are said to be stable. For other atoms, the numbers of nucleons are less favorable and the atom is unstable (radioactive) ^[11].

2.4 Modes of radioactive decay

Radioactive parents X with atomic number Z and atomic mass number A decays into a daughter Y through the following possible modes of decay: α , β^- , β^+ , γ , internal conversion and electron capture ^[12].

2.4.1 Alpha Particles decay

Alpha is large particle ejected by the heavier nuclides. Almost all naturally occurring alpha emitters are heavy elements with $Z \geq 83$. It contains two protons and two neutrons (no electrons) and is, in effect, a helium nucleus. Thus, the atomic number decreases by two and the mass number decrease by four. Even though alpha particles are very energetic, they are so heavy that they use up their energy over short distances and are unable to travel very far from the atom. The health effect from exposure to alpha particles depends greatly on how a person is exposed. Alpha particles lack the energy to penetrate even the outer layer of skin Fig. (2.1), so exposure to the outside of the body is not a major concern. Inside the body, however, they can be very harmful. If alpha-emitters are inhaled, swallowed, or get into the body through a cut, the alpha particles can damage sensitive living tissue. The way these large, heavy particles cause damage makes them more dangerous than other types of radiation. The ionizations they cause are very close together, they can release all their energy in a few cells. This results in more severe damage to cells and DNA.

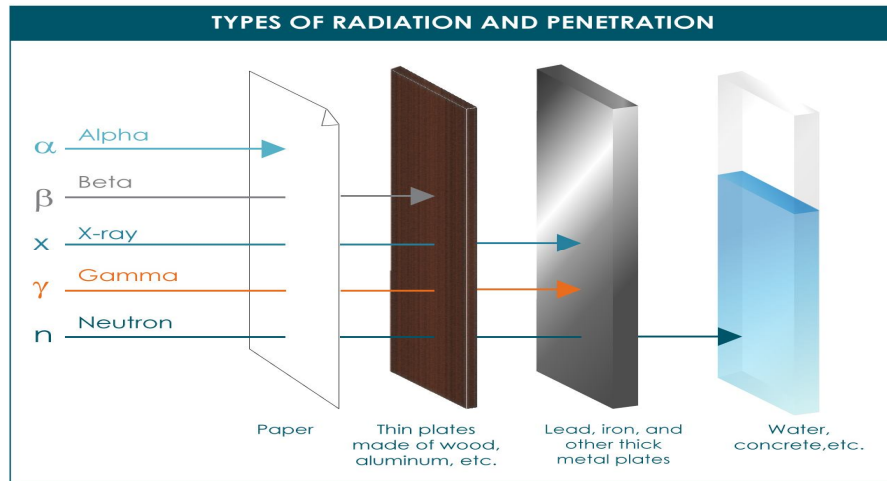

Figure 2.1: Type of radiation and penetration



Where ${}^4_2 He (\alpha)$ is a ${}^4_2 He$ nucleus referred to as an α particle.

As an example of alpha decay, we consider ${}^{226}_{88} Ra$



The energy Q released in the decay arises from a net loss in the masses $M_{Ra,N}$, $M_{Rn,N}$, and $M_{He,N}$, of the radium, radon, and helium nuclei:

$$Q = M_{Ra,N} - M_{Rn,N} - M_{He,N} \quad 2.3$$

Letting m and v represent the mass and initial velocity of the alpha particle and M and V those of the recoil nucleus, we write

$$mv = MV \quad 2.4$$

Since the initial kinetic energies of the products must be equal to the energy released in the decay, we have

$$\frac{1}{2} mv^2 + \frac{1}{2} MV^2 = Q \quad 2.5$$

Substituting $V = mv/M$ from Eq. 2.4 into 2.5 and solving for v^2 , one finds

$$v^2 = \frac{2MQ}{m(m+M)} \quad 2.6$$

One thus obtains for the alpha-particle energy

$$E_\alpha = \frac{1}{2}mv^2 = \frac{MQ}{m+M} \quad 2.7$$

With the roles of the two masses interchanged, it follows that the recoil energy of the nucleus is:

$$E_N = \frac{1}{2}MV^2 = \frac{mQ}{m+M} \quad 2.8$$

The conservation of momentum and energy, Eq. (2.4) and (2.5) fixes the energy of an alpha particle uniquely for given values of Q and M . Alpha particles therefore occur with discrete values of energy.

2.4.2 Negative beta particle (β^-) decay

Negative Beta particles (β^-) or *negatron* are small, fast-moving particles with a negative electrical charge that are emitted from an atom's nucleus during radioactive decay. These particles are emitted by certain unstable atoms.

Beta particles are more penetrating than alpha particles but are less damaging to living tissue and DNA because the ionizations they produce are more widely spaced. They travel farther in air than alpha particles, but can be stopped by a layer of clothing or by a thin layer of a substance such as aluminum. Some beta particles are capable of penetrating the skin and

causing damage such as skin burns. However, as with alpha-emitters, beta-emitters are most hazardous when they are inhaled or swallowed.

In beta decay, a nucleus simultaneously emits an electron, or negative beta particle, ${}_{-1}^0\beta$ and an antineutrino, ${}_{0}^{0-}\bar{\nu}_e$. Both of these particles are created at the moment of nuclear decay.

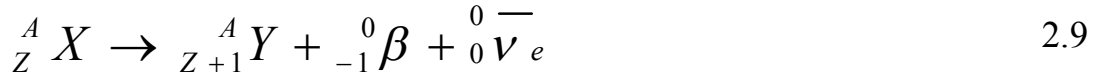

A neutron transforms into a proton, and an electron β^- and antineutrino ${}_{0}^{0-}\bar{\nu}_e$, sharing the available energy, are ejected from the nucleus.

As an example of beta decay, we consider ${}^{60}\text{Co}$:

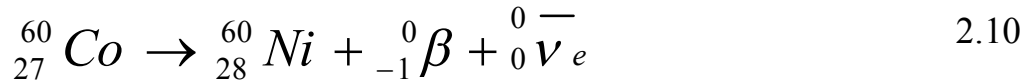

In this case, the value of Q is equal to the difference between the mass of the ${}^{60}\text{Co}$

nucleus, $M_{\text{Co},N}$, and that of the ${}^{60}\text{Ni}$ nucleus, $M_{\text{Ni},N}$, plus one electron (m):

$$Q = M_{\text{Co},N} - (M_{\text{Ni},N} + m). \quad 2.11$$

In accordance with (2.10), this energy is shared by the beta particle, antineutrino, and recoil ${}^{60}\text{Ni}$ nucleus. The latter, because of its relatively large mass, receives negligible energy, and so

$$E_{\beta^-} + E_{\bar{\nu}} = Q \quad 2.12$$

Where: E_{β^-} and $E_{\bar{\nu}}$ are the initial kinetic energies of the electron and antineutrino.

E_{β^-} and $E_{\bar{\nu}}$ can each have any value between zero and Q , subject to the condition (2.12) on their sum. Thus the spectrum of beta-particle energies E_{β^-} is continuous, with $0 \leq E_{\beta^-} \leq Q$, in contrast to the discrete spectra of alpha particles, as Eq. (2.7).

2.4.3 Positive beta particle (β^+) decay

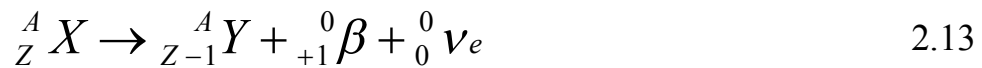

This decay Occurs in proton-rich nuclides, in which a proton transforms into a neutron, and a positron β^+ and neutrino ν_e , sharing the available energy, are ejected from the nucleus.

As an example of beta decay, we consider ${}^{22}_{11} Na$

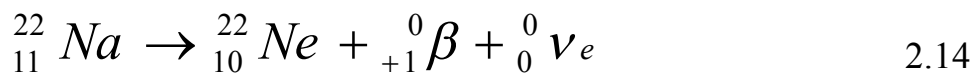

Positron decay reducing Z by one unit and leaving A unchanged. The energy released is given in terms of the masses $M_{Na,N}$ and $M_{Ne,N}$ of the sodium and neon nuclei by:

$$Q = M_{Na,N} - M_{Ne,N} - m. \quad 2.15$$

Thus the mass of the parent nucleus must be greater than that of the daughter nucleus by at least the mass m of the positron it creates.

2.4.4 Gamma Emission

Gamma rays (γ) are weightless packets of energy called photons. Unlike alpha and beta particles, which have both energy and mass, gamma rays are pure energy. Gamma rays are similar to visible light, but have much higher energy. Gamma rays are often emitted along with alpha or beta particles during radioactive decay.

Gamma rays are a radiation hazard for the entire body. They can easily penetrate barriers, such as skin and clothing that can stop alpha and beta particles. Gamma rays have so much penetrating power that several inches of a dense material like lead or even a few feet of concrete may be required to stop them. Gamma rays can pass completely through the human

body easily; as they pass through, they can cause ionizations that damage tissue and DNA.

One or more gamma photons can be emitted from the excited states of daughter nuclei following radioactive decay. Transitions that result in gamma emission leave Z and A unchanged and are called *isomeric*; nuclides in the initial and final states are called *isomers*.



An excited nucleus ${}^A_Z X^*$ generally produced through β^- or β^+ decay, attains its ground state ${}^A_Z Y$ through emission of one or several γ photons.

2.4.5 Internal conversion



Rather than being emitted as a γ photon, the nuclear excitation energy may be transferred to a K shell orbital electron that is ejected with a kinetic energy E_e equal to the excitation energy E^* less the orbital electron binding energy E_B , Eq.(2.18). The resulting K shell vacancy is filled with a higher level orbital electron and the transition energy is emitted in the form of characteristic photons or Auger electrons.

$$E_e = E^* - E_B \quad 2.18$$

2.4.6 Electron Capture

Some nuclei undergo a radioactive transformation by capturing an atomic electron, usually from the K shell, and emitting a neutrino.

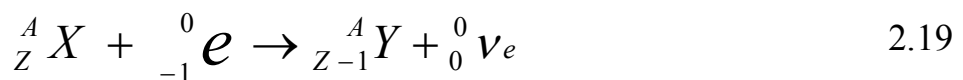

The resulting K shell vacancy is filled with a higher level orbital electron and the transition energy is emitted from the atom in the form of characteristic photons or Auger electrons.

As an example, we consider: $^{103}_{46}Pd$

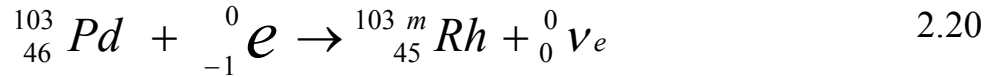

The neutrino acquires the entire energy Q released by the reaction. To find Q , we note that the captured electron releases its total mass, $m - E_B$, to the nucleus when it is absorbed there, E_B being the mass equivalent of the binding energy of the electron in the atomic shell. Therefore, in terms of the masses $M_{Pd,N}$ and $M_{Rh,N}$ of the parent and daughter nuclei, the energy released by the reaction Eq.(2.20) is given by:

$$Q = M_{Pd,N} + m - E_B - M_{Rh,N}. \quad 2.21$$

The neutrino emitted in electron capture has a negligible interaction with matter and offers no radiation hazard. Characteristic X rays of the daughter will always be present. In addition, if the capture does not leave the daughter in its ground state, gamma rays will occur ^{[13] [14] [8]}.

2.5 Interaction of Gamma radiation with matter

There are three main processes by which photons may interact with matter giving up all or part of their energy in single events. These are (1) the photoelectric effect, (2) Compton scattering by electrons in the atoms of the material, and (3) the production of a positron, electron pair in the electric field of an atom (Pair production).

In the photoelectric absorption process, the gamma ray loses all of its energy in one interaction. The probability for this process depends very strongly on gamma-ray energy E_γ and atomic number Z . In Compton scattering, the gamma ray loses only part of its energy in one interaction.

The probability for this process is weakly dependent on E and Z . The gamma ray can lose all of its energy in one pair-production interaction ^[15].

2.5.1 Photoelectric Absorption

A gamma ray may interact with a bound atomic, electron in such a way that it loses all of its energy and ceases to exist as a gamma ray Fig. (2.2). Some of the gamma-ray energy is used to overcome the electron binding energy, and most of the remainder is transferred to the freed electron as kinetic energy. A very small amount of recoil energy remains with the atom to conserve momentum. This is called photoelectric absorption. Photoelectric absorption is important for gamma-ray detection because the gamma ray gives up all its energy, and the resulting pulse falls in the full-energy peak ^[16].

The energy of the photoelectron E_e released by the interaction is the difference between the gamma-ray energy E_γ and the electron binding energy E_b , Eq. (2.22).

$$E_e = E_\gamma - E_b \quad 2.22$$

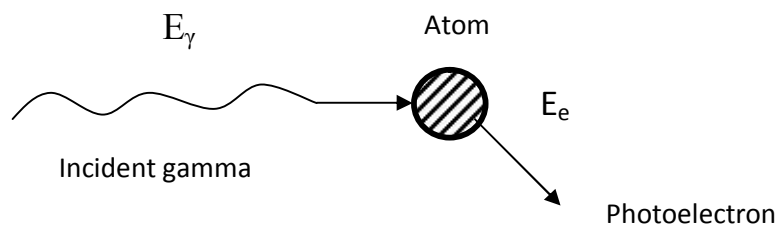

Figure 2.2: Photoelectric absorption process

2.5.2 Compton scattering

The interaction process of Compton scattering take place between the incident gamma ray photon and an electron in the absorbing material. It is most often the predominant interaction mechanism for gamma ray energies of radiostope sources.

In Compton scattering, the incoming gamma ray photon is deflected through an angle θ with respect to its original direction Fig. (2.3). The photon transfer a portion of its energy to the electron (assumed to be initially at rest), which is then known as *recoil electron*. Because all angles of scattering are possible, the energy transferred to the electron can vary from zero to a large function of gamma ray energy.

The expression that relates the energy transfer and the scattering angle for any given interaction can simply be derived by writing simultaneous equations for conservation of energy and momentum.

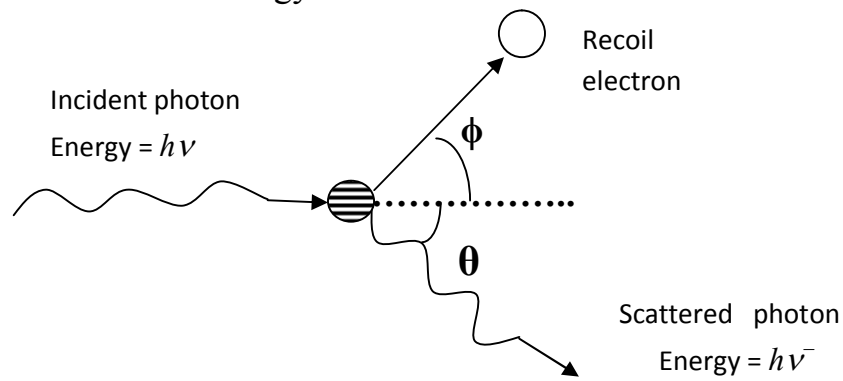

Figure 2.3: Compton scattered gamma photon

We can show that:

$$h\nu' = \frac{h\nu}{1 + \frac{h\nu}{m_0c^2}(1 + \cos\theta)} \quad 2.23$$

Where:

m_0c^2 : is the rest mass energy of the electron (= 0.511 MeV) ^[17].

2.5.3 Pair production

If the gamma ray energy exceed twice the rest mass energy of the electron (1.02 Mev), the process of pair production is energetically possible. In the interaction, the gamma ray photon disappears and is replaced by an electron – positron pair, Fig. (2.4). All the excess energy carried in by the photon above the 1.02 Mev required to create the pair goes into kinetic energy shared by positron and the electron ^[17].

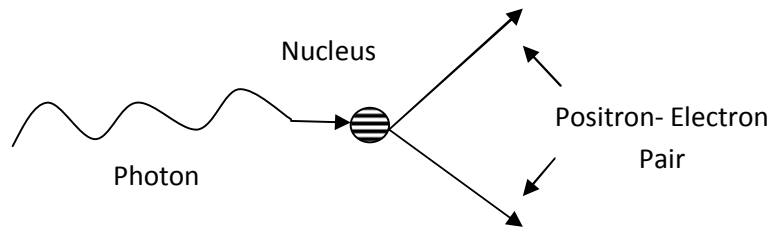

Figure 2.4: Pair production process

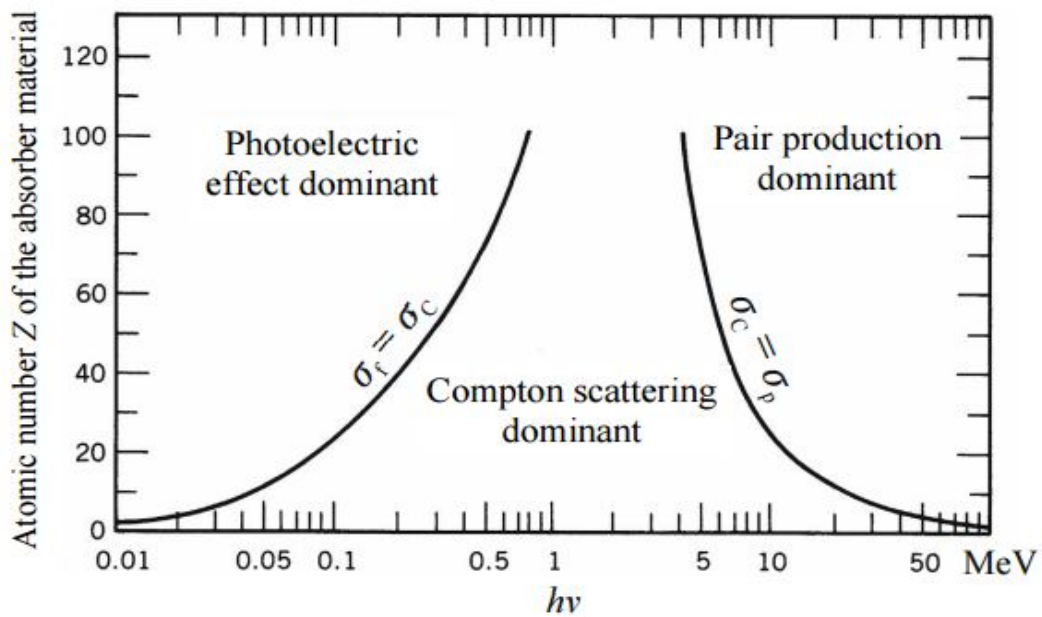

Figure 2.5: Interaction mechanisms of X and gamma-rays with matter

2.6 Law of Radioactive decay

Each unstable (radioactive) atom will eventually achieve stability by ejecting an alpha or beta particle. This shift to a more stable form is called *decay*. Each radioactive decay process is characterized by the fact that only a fraction of the unstable nuclei in a given sample will decay in a given time. The probability that a particular nucleus in the sample will decay during a time interval dt is λdt , where λ is the radioactive decay constant. It is defined as the probability that any particular nucleus will disintegrate in unit time. For a large number of like nuclei together, make the assumption that λ is independent of the age of a nucleus and is the same for all nuclei.

This means that λ is a constant. If N is the number of nuclei present at a time t , then the number of decays occurring in a time dt can be written $\lambda N dt$. As the number of nuclei decreases by dN in this time, we can write:

$$dN = -\lambda N dt \quad 2.24$$

The negative sign denotes that N is decreasing with time. Equation 2.24 shows that the rate of decay is proportional to the number of nuclei present. Equation 2.24 can be rearranged and integrated:

$$\int_{N_0}^N \frac{dN}{N} = \int_0^t \lambda dt \quad 2.25$$

$$\ln \frac{N}{N_0} = -\lambda t \quad 2.26$$

Or

$$N = N_0 e^{-\lambda t} \quad 2.27$$

Where N_0 is the number of radioactive nuclei present at time $t = 0$. Eq. (2.27) describes the exponential radioactive decay law, Fig. (2.6). In particular, the time taken for a given number of nuclei to decay to half that number, $T_{1/2}$:

$$\ln \frac{N_0/2}{N_0} = -\lambda T_{1/2} \quad 2.28$$

Solving for $T_{1/2}$ yields ^[18]

$$T_{1/2} = \frac{\ln 2}{\lambda} = \frac{0.693}{\lambda} \quad 2.29$$

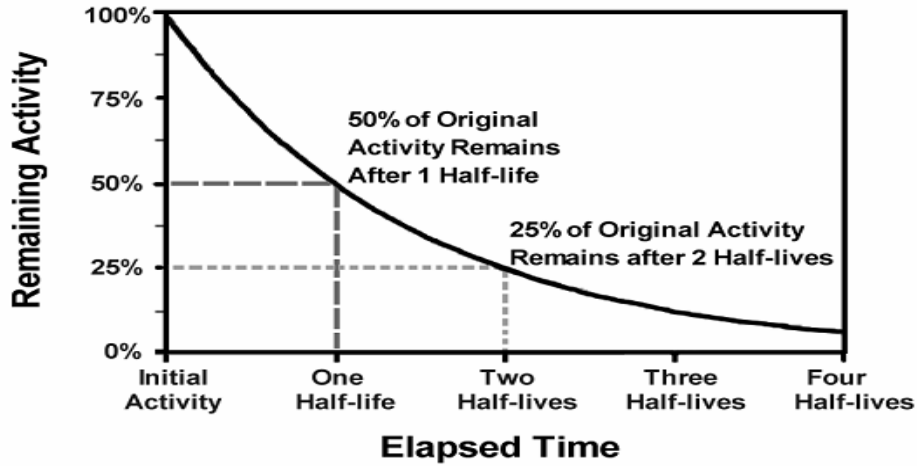

Figure 2.6: Exponential radioactive decay curve

The SI unit of activity is the Becquerel (Bq), equal to 1 decay/s, where the traditional unit is Curie (Ci) equal to 3.7×10^{10} Bq^[19].

2.7 Growth of activity from decay of a parent

When one radionuclide (the parent) decays into another radionuclide (the daughter), the rate of change of the number of daughter atoms must be the difference between the rate of growth from the parent and the rate of decay of the daughter:

$$\frac{dN_D}{dt} = \lambda_p N_p - \lambda_D N_D = \lambda_p N_{p0} e^{-\lambda_p t} - \lambda_D N_D \quad 2.30$$

where the subscripts “D” and “P” refer to daughter and parent, respectively, and the subscript “0” indicated the number of atoms at $t = 0$. Solving this linear differential equation gives:

$$N_D = N_{p0} \left[e^{-\lambda_p t} - e^{-\lambda_D t} \right] \frac{\lambda_p}{\lambda_D - \lambda_p} + N_{D0} e^{-\lambda_D t} \quad 2.31$$

The decay rate, or activity, A , is given by:

$$A = - \frac{dN}{dt} = \lambda N \quad 2.32$$

So From Eq. (2.32) we can rewrite this in terms of activity:

$$A_D = A_{Po} [e^{-\lambda_p t} - e^{-\lambda_D t}] \frac{\lambda_D}{\lambda_D - \lambda_p} + A_{D_0} e^{-\lambda_D t} \quad 2.33$$

To gain an understanding of this relationship as the ratio of parent to daughter half-lives varies, chemically separate the parent and daughter, in which case the second term of Eq. (2.33) is zero. We can then follow the change in their activities in the initially pure parent and calculate the total activity. There are three particular cases depending upon whether the parent half-life is greater or less than the daughter half-life ^[20]:

2.7.1 Transient equilibrium – $t_{1/2}$ parent > $t_{1/2}$ daughter

In a transient equilibrium, the activity of the daughter nuclide is in constant ratio to that of the parent nuclide and apparently decays with the half-life of the parent. In Figure 2.7, we see the decay of the parent unaffected by the absence or presence of daughter and the growth of the daughter activity. If we take Eq.(2.31) and set t to a value much greater than the half-life of the daughter, we can calculate the relative numbers of parent and daughter atoms at equilibrium:

$$\frac{N_D}{N_p} = \frac{\lambda_p}{\lambda_D - \lambda_p} \quad 2.34$$

And the equilibrium activity of the daughter relative to that of the parent:

$$\frac{A_D}{A_p} = \frac{\lambda_p}{\lambda_D - \lambda_p} \quad 2.35$$

Or in term of half-lives

$$\frac{A_D}{A_p} = \frac{t_{1/2 p}}{t_{1/2 p} - t_{1/2 D}} \quad 2.36$$

Where $t_{1/2p}$ and $t_{1/2D}$ are the half-lives of parent and daughter, respectively.

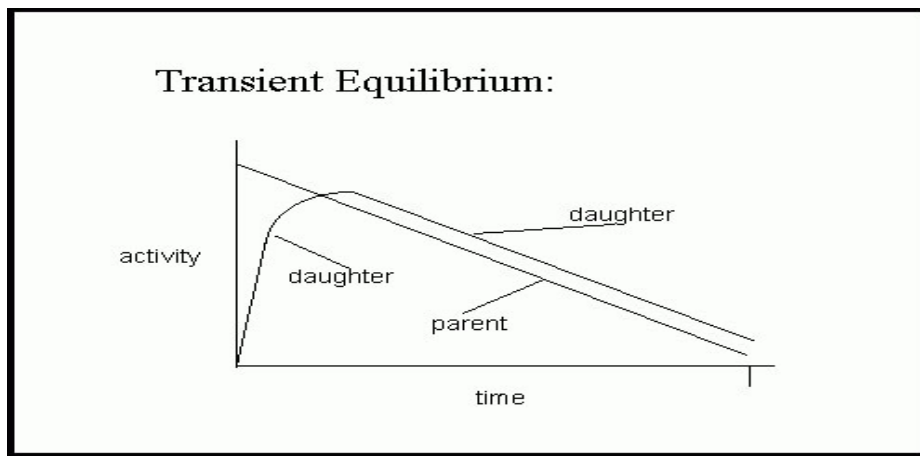

Figure 2.7: Transient equilibrium

2.7.2 Secular equilibrium – $t_{1/2 \text{ parent}} \gg t_{1/2 \text{ daughter}}$

If the half-life of the parent nuclide is very long compared to that of the daughter, the equilibrium state is referred to as secular equilibrium. In such situations, where $t_{1/2D}$ becomes negligible, Eq. (2.40) becomes $A_D = A_P$, i.e. the daughter activity equals the parent activity.

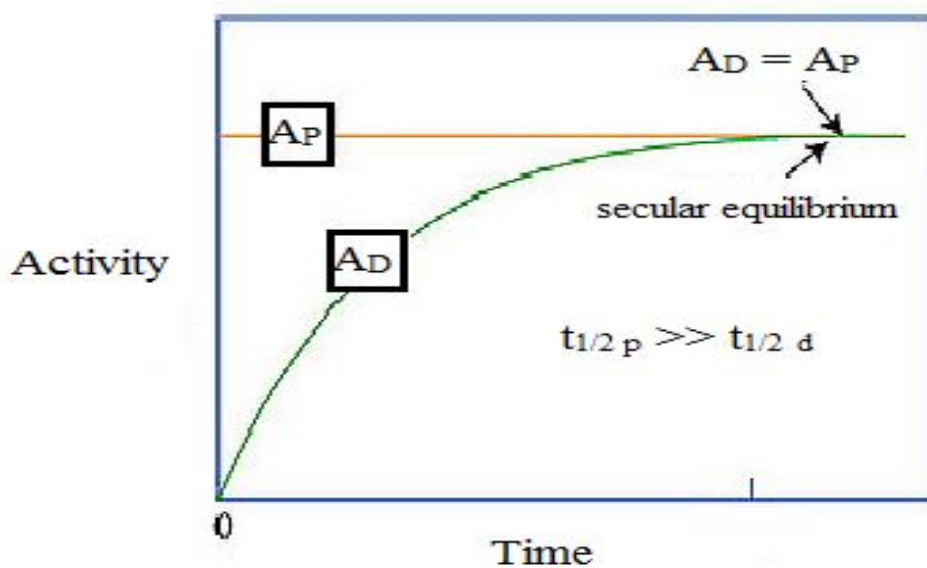

Figure 2.8: secular equilibrium

2.7.3 No equilibrium – $t_{1/2}$ parent < $t_{1/2}$ daughter

If the daughter half-life is greater than that of the parent then, the parent will decay, leaving behind the daughter alone. Fig. (3.9) shows the growth of daughter activity within an initially pure parent. No equilibrium is established; ultimately the decay curve will be that of the grown-in daughter ^[20].

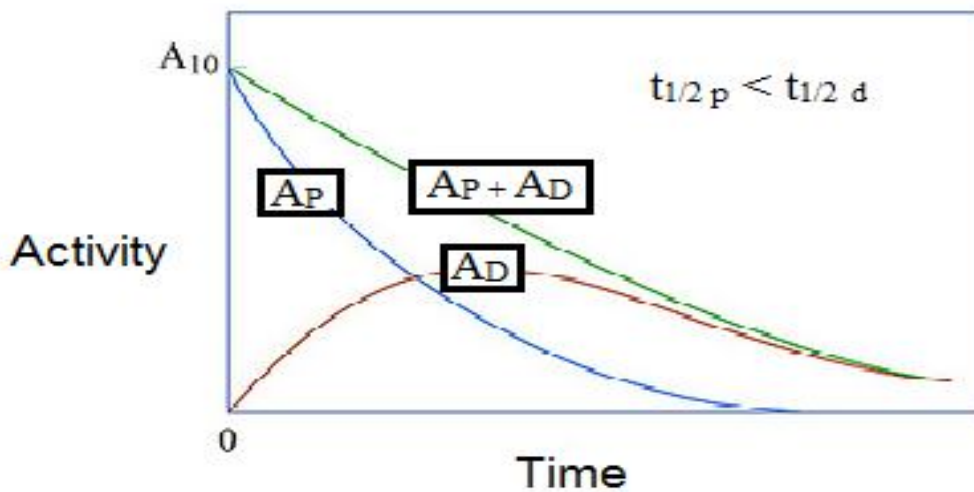

Figure 2.9: No equilibrium

2.8 Radioactive decay series

Solution for the case of a radioactive decay series, where a parent radionuclide decays to a daughter radionuclide, which in turn decays into a granddaughter radionuclide, was first derived by Bateman in 1910. Bateman used Laplace transformation to solve the set of differential equations that defines the problem. The decay equation for a radioactive nuclide series is:

$$\frac{dN_i}{dt} = \lambda_{i-1}N_{i-1} - \lambda_i N_i \quad 2.37$$

Where N_i and λ_i are respectively the number of nuclei present and the decay constant of the i^{th} nuclide, and $i \neq 1$. The general solution for the equation is given by Bateman as:

$$N_i = C_1 e^{-\lambda_1 t} + C_2 e^{-\lambda_2 t} + \dots + C_i e^{-\lambda_i t} \quad 2.48$$

Where C_1, C_2, \dots, C_i are coefficients given by

$$C_1 = \frac{\lambda_2 \lambda_3 \dots \lambda_{i-1}}{(\lambda_2 - \lambda_1)(\lambda_3 - \lambda_1) \dots (\lambda_i - \lambda_1)} N_0 \quad 2.49$$

$$C_2 = \frac{\lambda_1 \lambda_3 \dots \lambda_{i-1}}{(\lambda_1 - \lambda_2)(\lambda_3 - \lambda_2) \dots (\lambda_i - \lambda_2)} N_0 \quad 2.40$$

$$C_i = \frac{\lambda_1 \lambda_2 \dots \lambda_{i-1}}{(\lambda_1 - \lambda_i)(\lambda_2 - \lambda_i) \dots (\lambda_{i-1} - \lambda_i)} N_0 \quad 2.41$$

Where N_0 is the initial concentration of the parent nuclides, and assuming that all daughters initial concentration are equal to zero ^[21].

2.9 Natural decay series

Radionuclides are naturally found throughout all environments. They are present in varying amounts in air, water, plants, animals, soil and rocks. ^[22]

These radionuclides were present at the creation of the planet. Since some of these radionuclides have very long decay half-lives (on the order of hundreds of millions of years or more), significant quantities of these radionuclides are still present on the earth today. These radionuclides can be categorized into two types: (i) Singly Occurring Radionuclides (Primordial Radionuclides) and (ii) Decay Chains.

2.9.1 Primordial Radionuclides

About 20 naturally occurring single primordial radionuclides have been identified. Most are radioactive isotopes with half-lives $> 10^{10}$ years and usually around 10^{15} years. The majority decay by beta emission, but some, such as ^{147}Sm and ^{152}Gd undergo (relatively low energy) alpha decay. Only two of the singly occurring primordial radionuclides are significant and important to be considered: ^{40}K and ^{87}Rb .

^{40}K has a half-life of 1.277×10^9 years, an isotopic abundance of 0.0118 % and has a specific activity of 31.4 Bq/g for natural potassium. ^{40}K decays through β - decay to stable ^{40}Ca 89% of the time. The remaining 10.72% of ^{40}K undergoes decay by electron capture to stable ^{40}Ar . This latter decay branch also emits a characteristic gamma-ray at 1.461 MeV Fig (2.10). This line is very useful to identify and quantify ^{40}K by gamma spectrometry. It can also be useful in calibration because it presents in all environmental samples.

The other primordial occurring radionuclide which has a potential significance on the environment is ^{87}Rb . It has a natural abundance of 27.8%. Rubidium decays by beta to stable ^{87}Sr with a half-life of 4.8×10^{10} years. It is also an alkaline earth metal so it may replace potassium chemically in the human body. Like potassium, rubidium can also be found in trace amounts in soil and rock, with a concentration value of 10 ppm (corresponding to specific activities of ~ 7 (Bq/kg)). Typically most rocks contain from 10 to 200 ppm (7-19 Bq/kg) of ^{87}Rb .

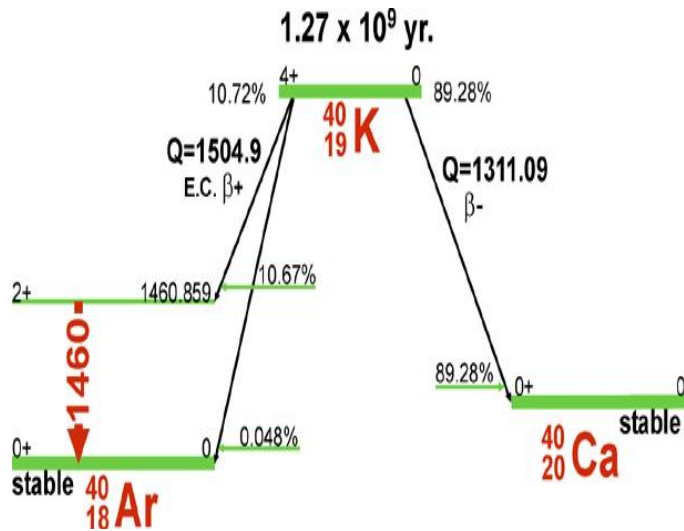

Figure 2.10: decay scheme for ^{40}K

2.9.2 Decay Chains

This natural decay chains Fig.(2.11) headed by ^{238}U (half-life 4.468×10^9 years), and ending with stable ^{206}Pb . Eight elements in the series emit gamma radiation, four of which are of significance for gamma spectroscopy. ^{232}Th (half-life 1.41×10^{10} years), and ending with stable ^{208}Pb . Only three elements in this series produce significant gamma radiations. ^{235}U (half-life 7.038×10^8 years), and ending with stable ^{207}Pb . Four of its elements emit reasonably intense gamma radiations [23].

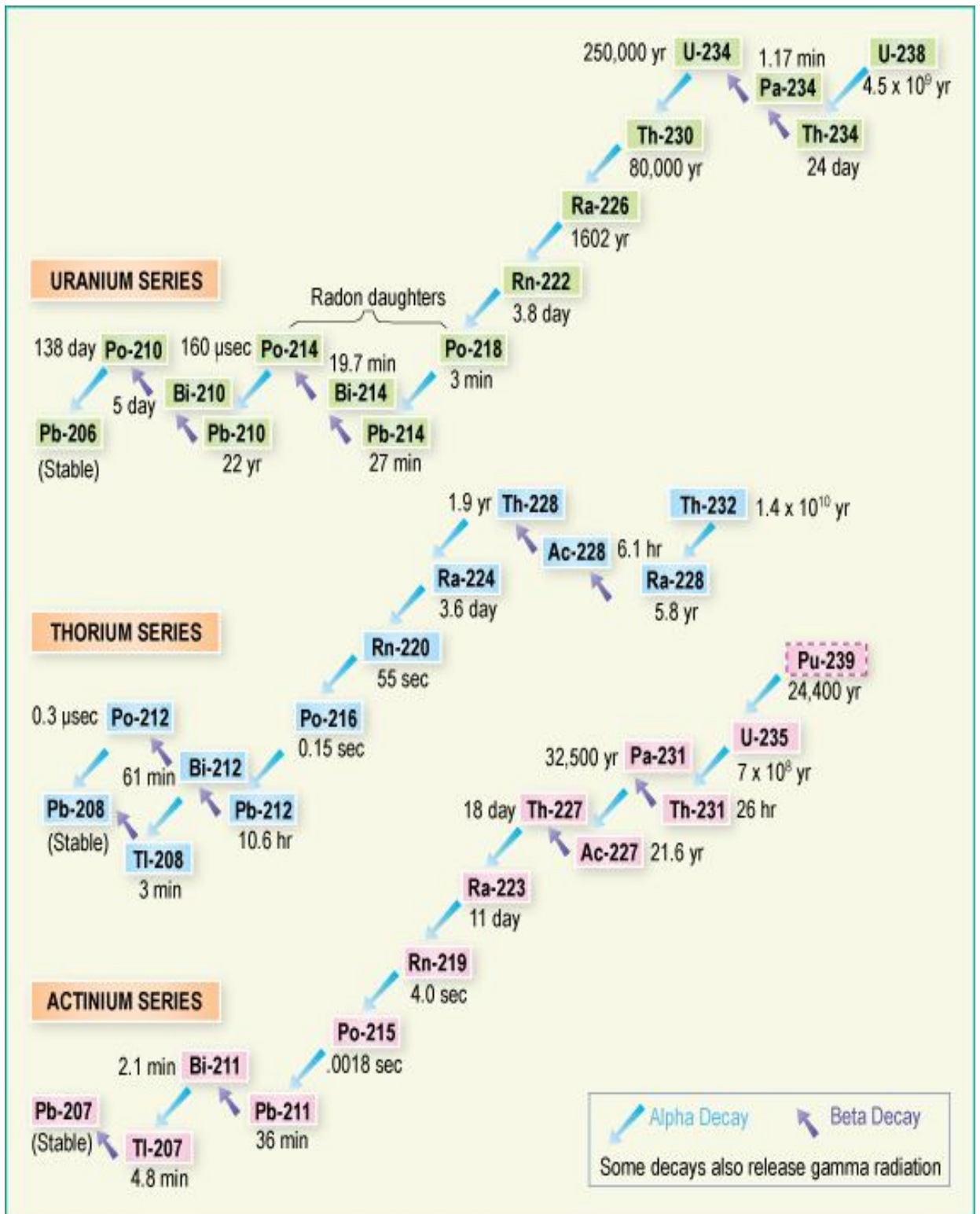

Fig 2.11: Decay chains for the three main naturally occurring radioactive decay series

2-10 NORM in oil and gas industry

2-10-1 Brief History of Norm in oil and gas fields

The first reports of NORM associated with mineral oil and natural gases appeared in 1904 ^[24].

In 1927, A. Tcherepennikov measure a radium concentration of 250 Bq/L in a brine sample taken from a well of the oil field *Uchta* in north east Russia. Since that time many papers on the radionuclides in oil and gas fields have been published manly by Soviet scientist. First results for brines from German oil fields near *Hanover*, were reported by H.J. Born and ranged from less than 1 to 13 Bq/L ^[25]. During the 1980's, considerably elevated concentrations of NORM were discovered in oil and gas equipment associated with the North Sea drilling operations of the United Kingdom. Subsequently, elevated radiation concentrations were discovered (1986) in some oil and gas equipment of the southern United States ^[26]. Later reports describe the occurrence of ²²⁶Ra in reservoir water from oil and gas fields. The radiological aspects of these phenomena, the results of monitoring and analyses and the development of guidelines for radiation safety are now reported extensively ^[24].

2-10-2 Origin of Norm in oil and gas fields

Radioactive materials such as Uranium and Thorium were incorporated in the Earth's crust when it was formed; these normally exist at trace (parts per million – ppm) concentrations in rock formations. Decay of these unstable radioactive elements produces other radionuclides that, under certain conditions (dependent upon pressure, temperature, acidity etc) in the subsurface environment are mobile and can be transported from the reservoir to the surface with the oil & gas products being recovered.

During the production process, NORM flows with the oil, gas and water mixture and accumulates in scale, sludge and scrapings. It can also

form a thin film on the interior surfaces of gas processing equipment and vessels. The level of NORM accumulation can vary substantially from one facility to another depending on geological formation, operational and other factors ^[27].

Radioactive decay of ^{238}U and ^{232}Th produces several series of daughter radioisotopes of different elements and of different physical characteristics with respect to their half-lives, modes of decay, and types and energies of emitted radiation. Analyses of NORM from many different oil and gas fields show that the solids found in the downhole and surface structures of oil and gas production facilities do not include ^{238}U and ^{232}Th . These elements are not mobilized from the reservoir rock that contains the oil & gas and formation water, Fig.(2.12). The formation water contains Group II (Periodic Table) cations of calcium, strontium, barium and radium dissolved from the reservoir rock. As a consequence, formation water contains the radium isotopes ^{226}Ra from the ^{238}U series and ^{228}Ra and ^{224}Ra from the ^{232}Th series. All three radium isotopes, but not their parents, thus appear in the water co-produced with the oil or gas. They are referred to as 'unsupported' because their long lived parents ^{238}U and ^{232}Th and also ^{228}Th remain in the reservoir ^[28].

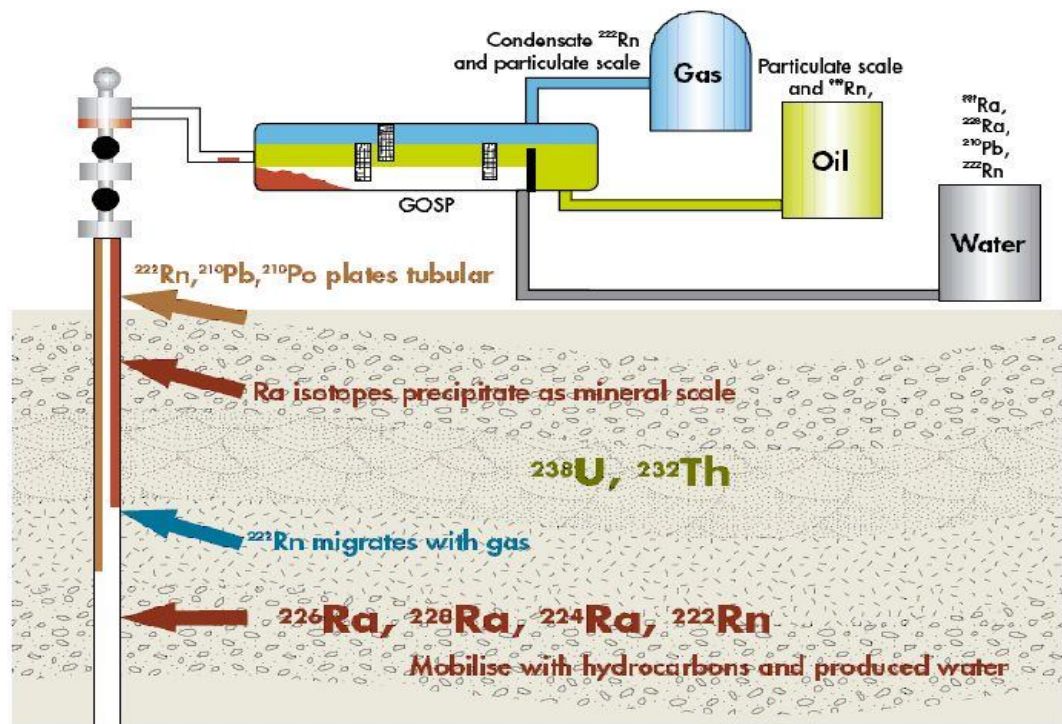

Figure 2.12: Origin of NORM in oil & gas industry

2-10-3 Radionuclides concentrations in oil and gas industry.

Over the production lifetime, the produced water may become increasingly more saline, indicating the co-production of brine. This may enhance the dissolution of the Group II elements — including radium — from the reservoir rock in a manner similar to the effect of seawater injection when it is used to enhance recovery. Therefore, over the lifetime of a well, NORM may be virtually absent at first but then start to appear later. The mobilization of lead with ^{210}Pb is also variable. The extent to which sludge is produced and the need to remove it regularly from separators and systems handling produced water also vary strongly between reservoirs, individual wells, installations and production conditions. As a consequence, there are neither typical concentrations of radionuclides in NORM from oil and gas production, nor typical amounts of scales and sludge being produced annually or over the lifetime of a well [24].

2-10-3-1 Norm in scale

The main types of scale encountered in oil & gas facilities are sulphate scale such as BaSO₄, SrSO₄ and carbonate scale such as CaCO₃. Radium is chemically similar to barium (Ba), strontium (Sr) and calcium (Ca), hence radium co-precipitates with Sr, Ba or Ca, scale forming radium sulphate, radium carbonate and in some cases radium silicate.

The mixing of seawater, which is rich in sulphate, with the formation water, which is rich in brine, increases the scaling tendency. Also the sudden change in pressure and temperature or even acidity of the formation water, as it is brought to the surface, contributes to scale build-up. This phenomenon has significant implications for the production of oil, Fig. (2.13); in this case the capacity of the pipe to transfer oil would be reduced significantly [27].

Scales are brittle minerals and thus scale build up in pipes and vessels frequently cracks due to temperature contractions of pipes, movement of flexible hoses etc. Scale debris is being removed from pipe surfaces and carried with crude oil and produced water. Coarse scale debris end up in separators Fig. (2.14) and sand traps, while fines end up in slops tanks [29]. Activity concentrations of some radionuclides in hard scale are listed in table (4-1).

Table 4-1: Activity concentration of ²³⁸U, ²²⁶Ra, ²³²Th and ²²⁸Ra in hard scales.

Radionuclide	Reported Range (Bq/g)
²³⁸ U	0.001 – 0.5
²²⁶ Ra	0.1 – 15,000
²³² Th	0.001 – 0.002
²²⁸ Ra	0.05 – 2,800



Figure 2-13: An abandoned pipeline due to heavy scale formation



Figure 2-14: A bulk of scale extracted during maintenance

2-10-3-2 Norm in sludge

Radioactive molecules containing radium which were not incorporated into scale can be found in sludge, produced sands and produced waters [27]. Sludge usually contains fine sand particles, corrosion particles, flakes of paint, bacteria growth and fines derived from scale. Sludge is usually accumulated in separator vessels and slops tanks of oil production facilities [29]. Activity concentration of some radionuclides in sludge is listed in table (4-2).

Table 4-2: Activity concentration of ^{238}U , ^{226}Ra , ^{232}Th and ^{228}Ra in Sludge.

Radionuclide	Reported Range (Bq/g)
^{238}U	0.005 – 0.01
^{226}Ra	0.05 – 800
^{232}Th	0.002 – 0.01
^{228}Ra	0.5 – 50



Figure 2-15: Sludge inside heater treater



Figure 2-16: Sludge bit at big receiver

2-10-3-3 Norm in sand

Small quantities of sand are carried in crude oil and coarse sand is trapped in sand traps located upstream from separators and in separators as well. In oil production facilities with scale build up, sand is highly contaminated with scale debris and radium content in this waste stream needs to be taken into account when disposing of such sands.

In facilities with high concentrations of calcium and carbonates, a rapid precipitation of coarse calcium carbonate particles may occur in those facility components with a positive temperature gradient. Such crystal precipitate usually accumulates in separators and a fine fraction increases the sludge production rate ^[29].

2-10-4 Norm hazards and precautions

In the absence of suitable radiation protection measures, NORM in the oil and gas industry could cause external exposure during production owing to accumulations of gamma emitting radionuclides and internal exposures of workers and other persons, particularly during maintenance, the transport of waste and contaminated equipment, the decontamination of equipment, and the processing and disposal of waste. Exposures of

a similar nature may also arise during the decommissioning of oil and gas production facilities and their associated waste management facilities.

2-10-4-1 External exposure

The deposition of contaminated scales and sludge in pipes and vessels may produce significant dose rates inside and outside these components. Short lived progeny of the radium isotopes, in particular ^{226}Ra , emit gamma radiation capable of penetrating the walls of these components, and the high energy photon emitted by ^{208}Tl (one of the progeny of ^{232}Th) can contribute significantly to the dose rate on outside surfaces when scale has been accumulating over a period of several months. The dose rates depend on the amount and activity concentrations of the radionuclides present inside and the shielding provided by pipe or vessel walls. Maximum dose rates are usually in the range of up to a few microsieverts per hour. In exceptional cases, dose rates measured directly on the outside surfaces of production equipment have reached several hundred microsieverts per hour which is about 1000 times greater than normal background values due to cosmic radiation and terrestrial radiation. Where scales are present, opening the system for maintenance or for other purposes will increase dose rates.

The presence of NORM in installations is unlikely to cause external exposures approaching or exceeding annual dose limits for workers. External dose rates from NORM encountered in practice are usually so low that protective measures are not needed. In exceptional cases where there are significant but localized dose rates, the following basic rules can be applied to minimize any external exposure and its contribution to total dose:

- (a) Minimizing the duration of any necessary external exposure.
- (b) Ensuring that optimum distances be maintained between any accumulation of NORM (installation part) and potentially exposed people;

(c) Maintaining shielding material between the NORM and potentially exposed people.

2-10-4-2 Internal exposure

Internal exposure to NORM may result from the ingestion or inhalation of radionuclides. This may occur while working on or in open plant and equipment, handling waste materials and surface contaminated objects, and during the cleaning of contaminated equipment. Ingestion can also occur if precautions are not taken prior to eating, drinking, smoking, etc.

In the absence of suitable control measures, internal exposure may result from the ingestion or inhalation of NORM while working with uncontained material or as a consequence of the uncontrolled dispersal of radioactive contamination. The risk of ingesting or inhaling any radioactive contamination present is minimized by complying with the following basic rules whereby workers:

- (a) Use protective clothing in the correct manner to reduce the risk of transferring contamination.
- (b) Refrain from smoking, drinking, eating, chewing, applying cosmetics (including medical or barrier creams, etc.), licking labels, or any other actions that increase the risk of transferring radioactive materials to the face during work.
- (c) Use suitable respiratory protective equipment as appropriate to prevent inhalation of any likely airborne radioactive contamination.
- (d) Apply, where practicable, only those work methods that keep NORM contamination wet or that confine it to prevent airborne contamination.
- (e) Implement good housekeeping practices to prevent the spread of NORM contamination.
- (f) Observe industrial hygiene rules such as careful washing of protective clothing and hands after finishing the work ^[30].

2-10-5 Doses Limits

The International Commission on Radiological Protection (ICRP) has recommended the annual effective dose equivalent limit of 1 mSvy^{-1} for the individual members of the public ^[31], and incidentally exposed workers, ^[32] and 20 mSvy^{-1} for the radiation workers, ^[31] (Occupationally exposed worker) ^[32].

Where:

Members of the Public are persons who have no occupational exposure to NORM.

Incidentally Exposed Workers are employees whose regular duties do not include exposure to NORM sources of radiation. They are considered as members of the public who work in an occupational exposure environment.

Occupationally Exposed Workers are employees who are exposed to NORM sources of radiation as a result of their regular duties. They are classified as NORM workers working in an occupational exposure environment ^[32].

It is recommended that the acceptable total absorbed dose rate by the workers in areas containing γ -radiations from ^{238}U and ^{232}Th series and their respective decay progenies, as well as ^{40}K , must not exceed 55 nGy/h ^[33].

2-11 Radiation detectors

2-11-1 Principle of detection

Detection of radiation is based on its interaction and the energy deposited in the material of which the detector is made. The ultimate goal is a formation of electron-ion pair inside the working volume of the detector because at the final stage of detection only electrically charged particle can be registered. They are collected on electrodes with the opposite charge due to voltage applied between them^[34] Fig. (2.17).

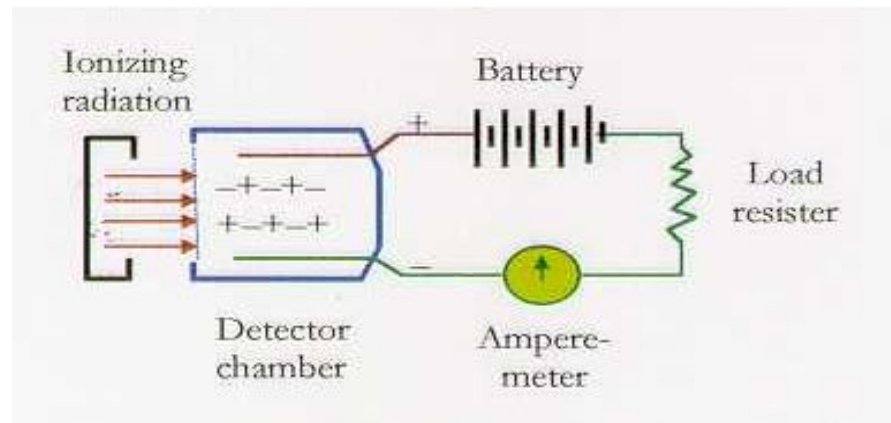

Figure 2.17 Key Components in a simple ionization chamber

2-11-2 Detector resolution and efficiency

The resolution of a detector is a measure of its ability to resolve two peaks that are close together in energy^[35].

The detection efficiency is a measure of the percentage of radiation that a given detector detects from the overall yield emitted from the source^[36].

2-11-3 Type of detectors

Many different detectors have been used to register the gamma ray and its energy, it is usually necessary to measure not only the amount of radiation emanating from a sample but also its energy spectrum. Thus, the detectors of most applications are those whose signal outputs are

proportional to the energy deposited by the gamma ray in the sensitive volume of the detector ^[35].

2-11-3-1 Gas-Filled Detectors

Most gas-filled detectors belong to a class of detectors called *ionization detectors*. These detectors respond to radiation by means of ionization induced electrical currents. A volume of gas is contained between two electrodes having a voltage difference (and thus an electric field) between them. The negative electrode is called the *cathode*, the positive electrode the *anode*. Under normal circumstances, the gas is an insulator and no electrical current flows between the electrodes. However, radiation passing through the gas causes ionization, both direct ionization from the incident radiation and secondary ionization from γ rays. The electrons produced by ionization are attracted to the positive electrode and the ionized atoms to the negative electrode, causing a momentary flow of a small amount of electrical current. Gas-filled detectors include *ionization chambers*, *proportional counters*, and *Geiger- Müller (GM) counters* ^[37].

The energy resolution of Gas-Filled Detectors is intermediate between NaI scintillation counters and germanium (Ge) solid-state detectors, ^[35] and the detection efficiency for x and γ rays are quite low ^[37].

2-11-3-2 Semiconductor Detectors

Semiconductor detectors are essentially solid state analogs of gas-filled ionization chambers.

Semiconductor detectors normally are poor electrical conductors; however, when they are ionized by an ionizing radiation event, the electrical charge produced can be collected by an external applied voltage, as it is with gas filled detectors. This principle could not be applied using a conducting material for the detector because such a material would conduct a large amount of current even without ionizing events. Insulators are not

suitable detector materials either, because they do not conduct even in the presence of ionizing radiation. Hence only semiconductor materials can function as “solid ionization chambers.” The most commonly used semiconductor detector materials are silicon (Si) and germanium (Ge) [37].

Germanium possesses the most ideal electronic characteristics in this regard, and is the most widely used semiconductor material in solid-state detector. The gamma-ray energy resolution of these detectors is dramatically better than that of scintillation detectors; so greater spectral detail can be measured [35]. High purity germanium or simply (HPGe) is the most common detector of this type.

2-11-3-3 Scintillation detectors

Collected samples were analysed using sodium iodide (NaI) scintillation counter, so we will take this type of detectors in detail.

2-11-3-3-1 Basic Principles

Radiation from radioactive materials interacts with matter by causing ionization or excitation of atoms and molecules. When the ionized or excited products undergo recombination or de-excitation, energy is released. Most of the energy is dissipated as thermal energy, such as molecular vibrations in gases or liquids or lattice vibrations in a crystal; however, in some materials a portion of the energy is released as visible light. These materials are called *scintillators*, and radiation detectors made from them are called *scintillation detectors*. The limitations on counting speed and accuracy with this system have been eliminated in modern application with the introduction of ultrasensitive electronic light detectors called *photomultiplier tubes (PMT)* [37].

The scintillation material may be organic or inorganic; the latter is more common. Some common inorganic scintillation materials are sodium

iodide (NaI), cesium iodide (CSI), zinc sulfide (ZnS), and lithium iodide (LiI).

When gamma rays interact in scintillator material, ionized (excited) atoms in the scintillator material “relax” to a lower-energy state and emit photons of light. In a pure inorganic scintillator crystal, the return of the atom to lower-energy states with the emission of a photon is an inefficient process. Furthermore, the emitted photons are usually too high in energy to lie in the range of wavelengths to which the PMT is sensitive. Small amounts of impurities (called activators) are added to all scintillators to enhance the emission of visible photons. Crystal de-excitations channeled through these impurities give rise to photons that can activate the PMT. One important consequence of luminescence through activator impurities is that the bulk scintillator crystal is transparent to the scintillation light. A common example of scintillator activation encountered in gamma-ray measurements is thallium-doped sodium iodide [NaI(Tl)]^[35].

2-11-3-3-2 Photomultiplier Tubes (PMT)

PM T (also called *phototubes*) are electronic tubes that produce a pulse of electrical current when stimulated by very weak light signals, such as the scintillation produced by a γ ray or β particle in a scintillation detector, Fig (2-18).

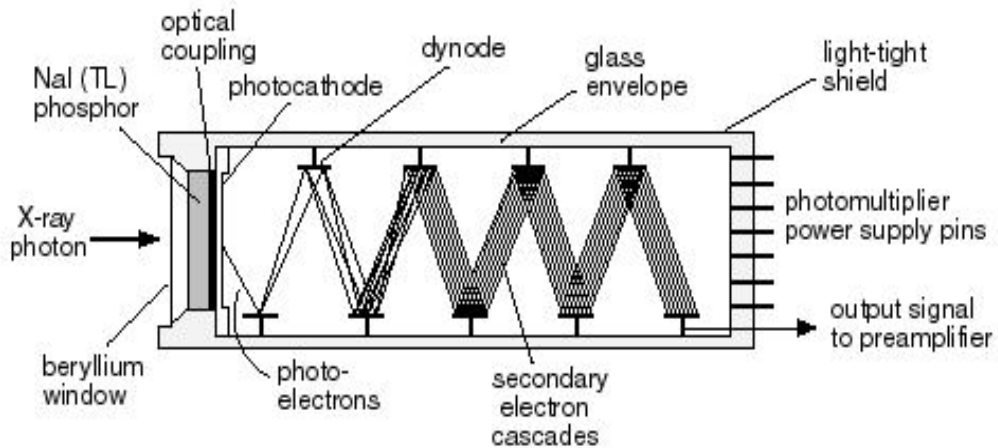

Figure 2.18 Scintillation detector

The inside front surface of the glass *entrance window* of the PMT is coated with a photoemissive substance. A *photo emissive* substance is one that ejects electrons when struck by photons of visible light.

The photoemissive surface is called the *photocathode*, and electrons ejected from it are called *photoelectrons*. A short distance from the photocathode is a metal plate called a *dynode*. The dynode is maintained at a positive voltage (typically 200-400V) relative to the photocathode and attracts the photoelectrons ejected from it. The dynode is coated with a material having relatively high secondary emission characteristics. A high-speed photoelectron striking the dynode surface ejects several *secondary electrons* from it. The electron multiplication factor depends on the energy of the photoelectron, which in turn is determined by the voltage difference between the dynode and the photocathode. Secondary electrons ejected from the first dynode are attracted to a second dynode, which is maintained at a 50-150V higher potential than the first dynode, and the electron multiplication process is repeated. This occurs through many additional dynode stages (typically 9 to 12 in all), until finally a shower of electrons is collected at the *anode*.

The amount of current produced is proportional to the intensity of the light signal incident on the photocathode and thus also to the amount of energy deposited by the radiation event in the crystal.

PM tubes require a high-voltage supply, and the voltage supply must be very stable because the electron multiplication factor is very sensitive to dynode voltage changes. PM tubes are sealed in glass and evacuated. Electrical connections to the dynodes, the photocathode, and the anode are made through pins in the tube. The focusing of the electron beam from one dynode to the next can be affected by external magnetic fields, Therefore PM tubes often are wrapped in metal foil for magnetic shielding ^[37].

2-11-4 Efficiency and resolution of HPGe and NaI(Tl) detectors

High purity germanium detector (HPGe) has better resolution compared to the scintillation type of detector, Sodium iodide (NaI). The HPGe detector offers the advantage of resolving two closely located energy points and has the ability to detect a mixture of nuclear material ^[38]. NaI(Tl) have very poor radiation resolutions due to the fact that the process of converting an incident radiation to light and then to an electrical signal is not only long, but it is inefficient as well. Semiconductors do not have to suffer through this laborious process, and therefore their resolution is much higher ^[39]. Even though HPGe has very good resolution, it is less efficiency than the NaI (Tl) detector. Its efficiency decreases exponentially with energy and only can detect nuclides with lower energy rather than nuclides at higher energy ^[38].

CHAPTER III

SAMPLES PREPARATION AND EXPREMENTAL METHOD

3-1 fields trips

Fields trips were carried out from Nov-2014 to Oct.-2015 to four oil fields in West Kourdoфан state which operates by Grater Nile Operating Company “GNPOC”. These fields are (Heglig, Neem, Diffra and Bamboo oil fields), where Heglig & Bamboo located in block “2”, and Neem & Diffra in block “4”, Fig (3.1).

The aim of these trips were to collect samples for analysis and so to determined type, concentration of Natural Occurrence Radioactive material in these samples, absorbed dose rate and annual effective doses.

In this research 32 Samples were collected (seven scale, ten sludge, thirteen sand, one contaminated grass and one sample of crude oil – Latitude, Longitude and Google photos for sampling location in (Appendices) - some samples were collected from one location but at different time (about one year).

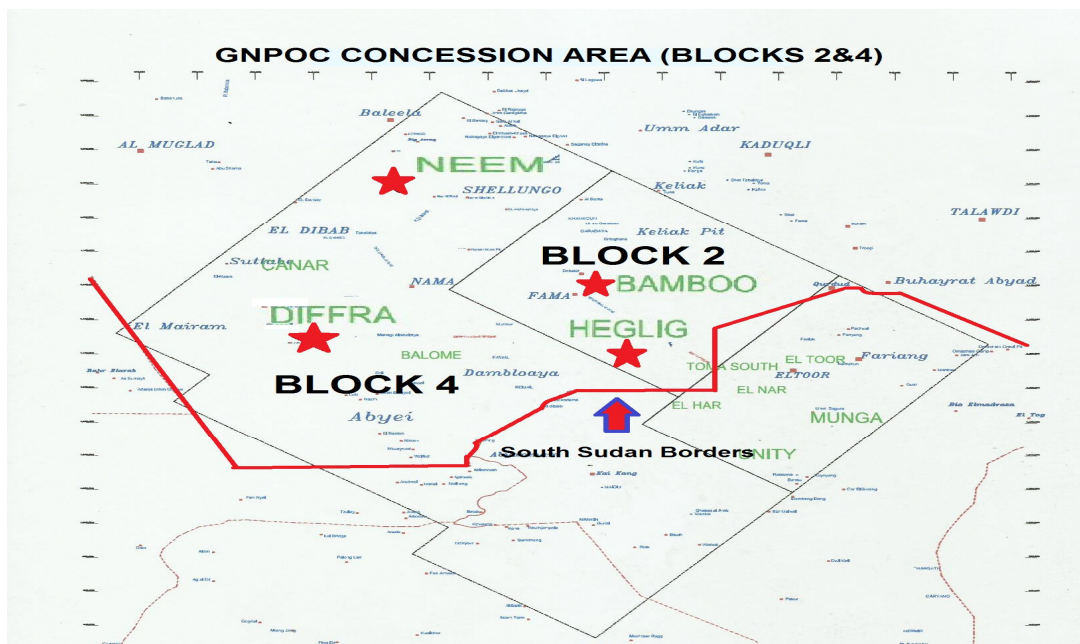

Figure 3.1: Map showing Sampling areas

3-2 Sampling and sample preparations

Samples were taken manually after full PPE (Disposable coverall, respiratory mask, gloves, glass, helmet and safety boot). Scale samples were taken by using hammer, chisel and brush. Sand with plastic shovel and brush. Sludge samples were taken with plastic shovel.

Some Samples were collected during routine maintenance, some scale samples extracted from rejected pipes and other samples collected from drums located in special closed area.

For Scale samples collection, plastic sheet was used to cover the soil under the work area, and another sheet to cover the sampling point. The chisel and hammer were used to remove scale which was then collected using brush and shovel, this for pipes scale. Tanks and vessel scale and scale from drums were collected directly using chisel and hammer. Sand samples were collected using plastic shovel and brush. Sludge samples were taken with plastic shovel.

Each sample was placed into two successive plastic bags and each was tied at the top and labeled. Then each bagged sample was taken away from the collection site and placed in a third bag and tied at the top to ensure secure containment.

Scale and Soil samples were then air-dried and carefully ground with mortar and pestle. The material was then sieved through a 2-mm mesh sieve. Sludge samples were directly placed into beakers.

The samples was placed into Marinelli beakers and weighted. The containers were sealed to avoid any possibility of out gassing of radon and kept for a period of more than four weeks before counting, in order to allow of secular equilibrium of parent with its short-lived progeny to take place.

3-3 Experimental Method

Each sample was placed into Marinelli beakers for more than four weeks before counting.

3-3-1 Marinelli beaker

Environmental samples of low-level radioactivity are often measured in Marinelli beakers Fig (3.2). They made from chemically resistant polypropylene and are available for gamma spectral analysis of a variety of liquid solutions or solid samples. These Marinelli beakers are advantageous for the following reasons:

1. Higher counting efficiencies.
2. Lighter weight.
3. It requires mini storage space.
4. Seamless, thin-wall construction eliminates leakage and minimizes gamma ray attenuation.
5. Cost effective.



Figure 3.2: Marinelli Beaker

3-3-2 Calibration process

Calibration process carried out for gamma spectroscopy using standard calibration source MW652 Fig (3.3) as reference source which recommended of International Atomic Energy Agency including sources ^{137}Cs (662 Kev) and ^{60}Co with two energies (1173,1333) Kev.



Figure 3.3: standard calibration source MW652

3-3-2-1 Energy calibration

When gamma spectrometer is used for identifying samples of unknown composition, its energy scale must be calibrated first. Energy calibration source was performed using cesium-137 or cobalt-60. Because the channel number is proportional to energy, the channel scale can then be converted to an energy scale Fig (3.4).

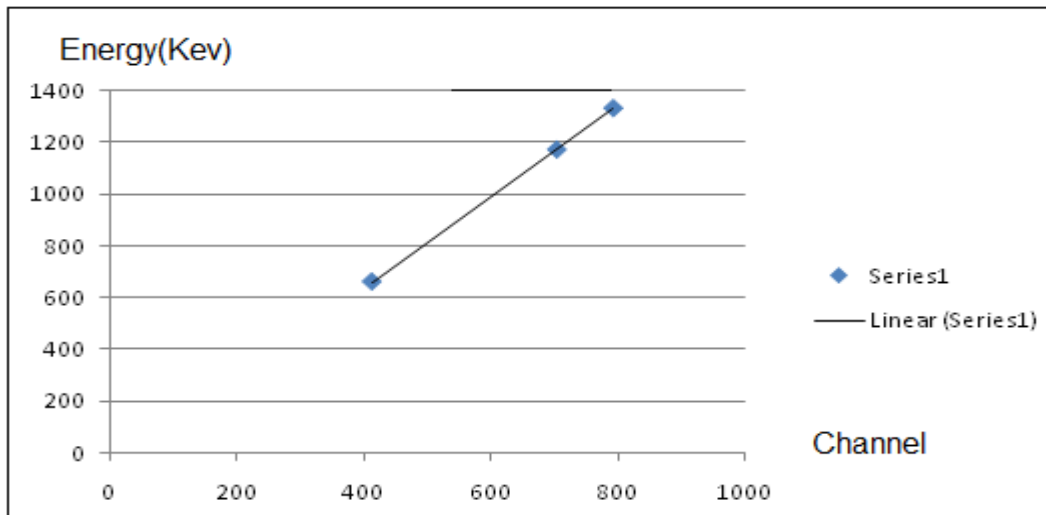

Figure 3.4: Energy calibration curve for NaI(Tl) detector

3-3-2-2 Efficiency calibration

Detector efficiency calibration Fig (3.5) was performed using a mixed radionuclide sources (MW652) in Marinelli beaker geometry. The spectrum was analyzed using the software “winTMCA32”. The following equation was used to obtain the efficiency curve of the detector for different energies:

$$\eta = \frac{Count (CPS)}{I_{\gamma} \times A (Bq / Kg)} \quad 3.1$$

Where, η is the efficiency of the detector at specific energy; I_{γ} is gamma intensity, and A is the activity of the standard.

Table 3.1 illustrate radionuclides, energies and corresponding efficiencies of the radionuclide's in the standard calibration source.

Table 3-1: Efficiency for calibration source

Radionuclide	Energy (KeV)	CPS	Activity	i_{γ}	Efficiency
Cs - 137	662	27.87	2147.005	0.851	0.015254
Co - 60	1173	5.22	805.5982	0.9997	0.006482
Co - 60	1333	4.74	805.5982	0.9998	0.005885

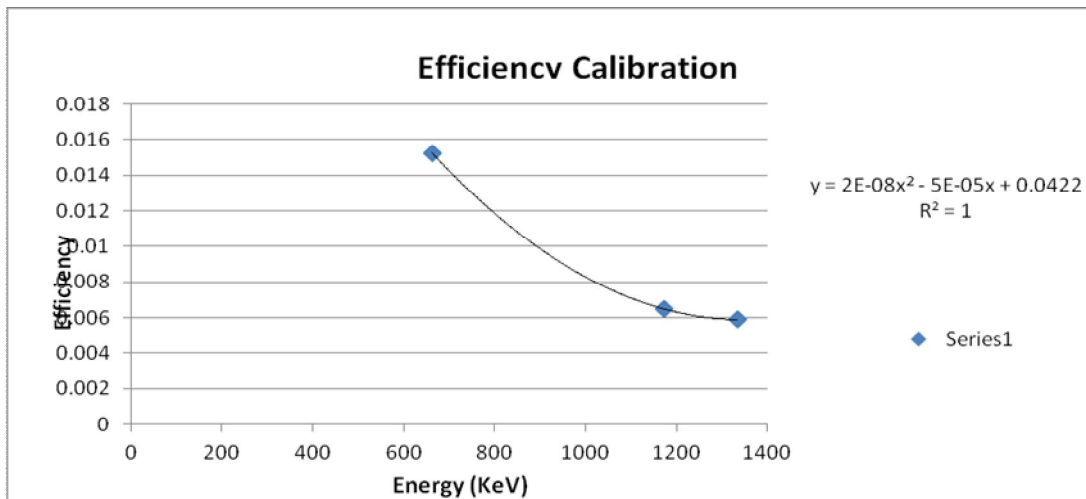

Figure 3.5 Efficiency Calibration curve

3-4 Sample measurements

Samples were analysed using NaI(Tl) detector Fig (3.6) which is a gamma spectroscopy system consists of a detector, Multichannel analyser to collect and process the signals produced by the detector, and a computer with processing software to generate, display, and store the spectrum. Other components, such as rate meters and peak position stabilizers, may also be included. (winTMCA32 scinti SPEC) is the software program for gamma spectroscopy.

Each sample was placed onto the detector and measured for at least three hours. Radionuclides known by the peaks of spectrum Fig (3.7) corresponding to definite energy, each peak represent count per second. The ^{238}U concentration was determined from the average concentrations of the ^{214}Bi (609 Kev), ^{214}Pb (352 keV) and ^{214}Pb (295 keV) decay products. ^{232}Th concentration was determined from the concentrations of the ^{212}Pb (238 keV). ^{40}K concentration was determined directly using its (1460 keV).



Figure 3.6: NaI(Tl) detector

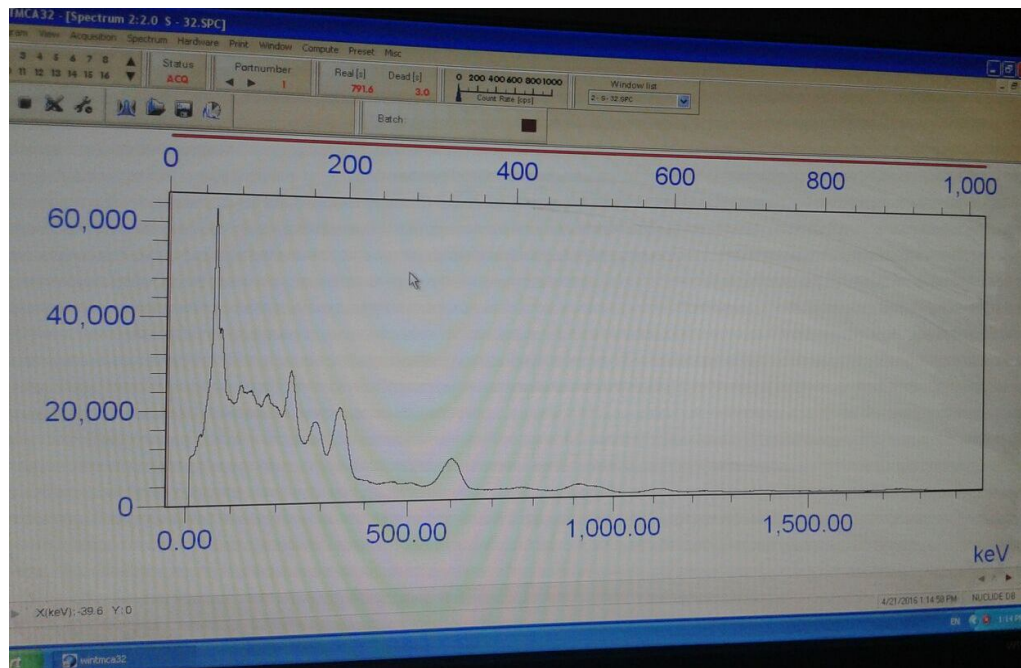

Figure 3.7: Sample S-32 Spectrum

3-5 Calculations

3-5-1 Activity Concentration

The activity concentrations were calculated for the radionuclides in the samples using the following equation

$$A = \frac{N}{I_{\gamma} \times \eta \times m}$$

Where:

“A” : is activity concentration of the sample (Bq/Kg).

“N” : is the net area of the peak (count per second).

“ I_{γ} ” : is gamma intensity – (0.433 ^{212}Pb) ^{232}Th , (0.461 for ^{214}Bi , 0.376 and 0.193 for ^{214}Pb 352 Kev ^{214}Pb and 295 Kev respectively) ^{238}U and 0.11 for ^{40}K

“ η ” : is the efficiency of the detector at specific energy (0.0312 for ^{212}Pb) ^{232}Th - 0.0189 for ^{214}Bi , (0.0268 and 0.0289 for ^{214}Pb 352 Kev and ^{214}Pb 295 Kev respectively) ^{238}U , 0.0116 for ^{40}K

“M” : is the mass of the measured sample (kg).

3-5-2 Absorbed dose rate

The gamma dose rate (D) in nGy/hr caused by naturally occurring radioactive materials in air at 1 m above the ground surface can be estimated using the following equation ^[40].

$$D = 0.462A_{\text{U-238}} + 0.604A_{\text{Th-232}} + 0.0417A_{\text{K-40}}$$

Where:

$A_{\text{U-238}}$: Activity concentration of ^{238}U in (Bq/Kg).

$A_{\text{Th-232}}$: Activity concentration of ^{232}Th in (Bq/Kg).

$A_{\text{K-40}}$: Activity concentration of ^{40}K in (Bq/Kg).

3-5-3 Annual Effective Dose

The annual estimated average effective dose equivalent received was calculated using a conversion factor of 0.7 SvGy⁻¹. The outdoor occupancy factor is about 0.2. The annual effective dose (AED) is given by the following equation ^[23].

$$\text{AED (mSv/y)} = \text{D (nGy/h)} \times 8760 \text{ (h/y)} \times 0.2 \times 0.7 \text{ (Sv/Gy)} 10^{-6}$$

CHAPTER IV

RESULT AND DISCUSSIONS

4-1 Result

The results of Samples activity concentrations (in Bq/Kg), absorbed dose rate (in nGy/h) and annual effective dose were tabulated in Tables (4-1,2,3 and 4-4). Comparison between Annual Effective Dose (AED) result from different fields samples, and recommended AED for members of the public/incidental worker and occupationally workers are illustrated in Fig (4.1,2,3 and 4.4). Comparison of average activity concentration of radionuclides found in Scale, sludge and sand illustrate in Fig(4.5).

Table 4-1: Neem Field samples activity concentration, absorbed dose rate and annual effective dose results:

No.	Sample ID	Concentration of ^{238}U (Bq/Kg)	Concentration of ^{232}Th (Bq/Kg)	Concentration of ^{40}K (Bq/Kg)	Absorber Dose Rate (nGy/h)	Annual Effective Dose (mSv/y)	Kind of sample
1	NHT1	4106.9	2736.7	3397	3692.01	4.53	Scale
2	NPT1	944.8	1156	9294	1522.28	1.87	Scale
3	NFT1	663.5	595.1	614.89	691.62	0.85	Sand
4	NCI2	56.75	91.7	353.52	96.35	0.12	Sludge
5	NHTD1-2	2183.84	1237.81	112.48	1761.26	2.2	Scale
6	NPTD2-2	1323.49	1203.80	16.06	1339.22	1.64	Sand
7	NHD3-2	1430.00	1081.05	64.28	1316.29	1.61	Sand
8	NUND4-2	2807.36	3466.24	111.25	3395.25	4.16	Sand
9	NHTD5-2	2641.77	2517.52	37.4	2742.64	3.36	Sand
10	NPTD6-2	2592.78	3137.52	110.28	3097.53	3.8	Sand
11	NS-28	743.15	733.52	16.07	787.05	0.97	Scale
12	NS-29	1392.74	1373.87	1285.53	1526.87	1.87	Scale
13	NS-30	455.54	320.91	16.07	404.96	0.5	Sludge
14	NS-31	655.36	396.34	16.07	542.84	0.7	Sludge
15	NS-32	647.81	393.38	16.07	537.56	0.66	Sludge

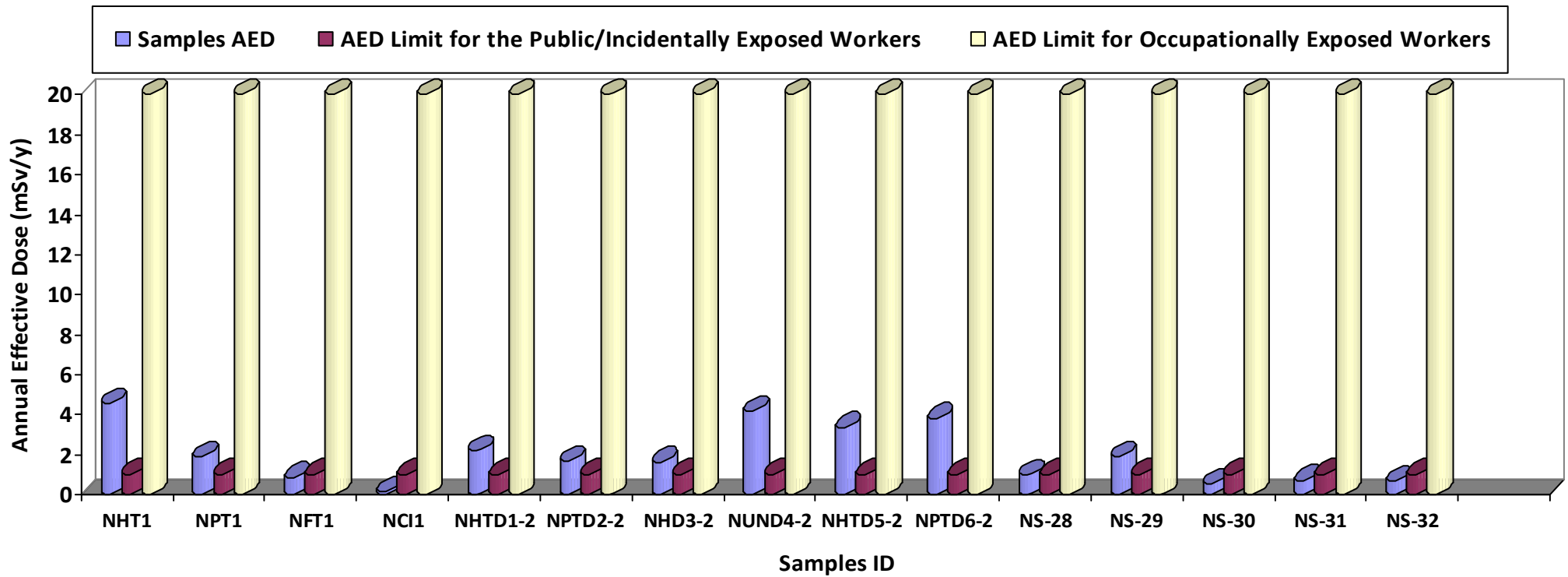

Figure 4.1: Comparison between Annual Effective Dose (AED) result from samples and AED limits for members of the public/Incidentally exposed workers and occupationally exposed workers - (Neem Field)

Table 4-2: Diffra Field samples activity concentration, absorbed dose rate and annual effective dose results:

No.	Sample ID	Concentration of ²³⁸ U (Bq/Kg)	Concentration of ²³² Th (Bq/Kg)	Concentration of ⁴⁰ K (Bq/Kg)	Absorber Dose Rate (nGy/h)	Annual Effective Dose (mSv/y)	Kind of sample
1	DHA-1	603.43	385	504.65	532.37	0.65	Scale
2	DO-1	9.7	16.19	92.62	18.12	0.02	Crude Oil
3	DP-1	64.11	63.69	22.13	69.01	0.08	Sludge
4	DW-2	358.05	375.88	133.9	398.03	0.49	Scale
5	DPR-2	81.21	90.21	96.41	96.03	0.11	Sludge

Table 4-3: Bamboo Field samples activity concentration, absorbed dose rate and annual effective dose results:

No.	Sample ID	Concentration of ²³⁸ U (Bq/Kg)	Concentration of ²³² Th (Bq/Kg)	Concentration of ⁴⁰ K (Bq/Kg)	Absorber Dose Rate (nGy/h)	Annual Effective Dose (mSv/y)	Kind of sample
1	BST-i2	13.89	14.6	196.28	23.42	0.02	Sand
2	BST-ii2	14.998	25.16	163.2	28.93	0.04	Sand
3	BTP-1	71.36	52.59	65.6	67.47	0.08	Sand
4	BNP-1	67.63	68.92	62.16	75.46	0.09	Sand

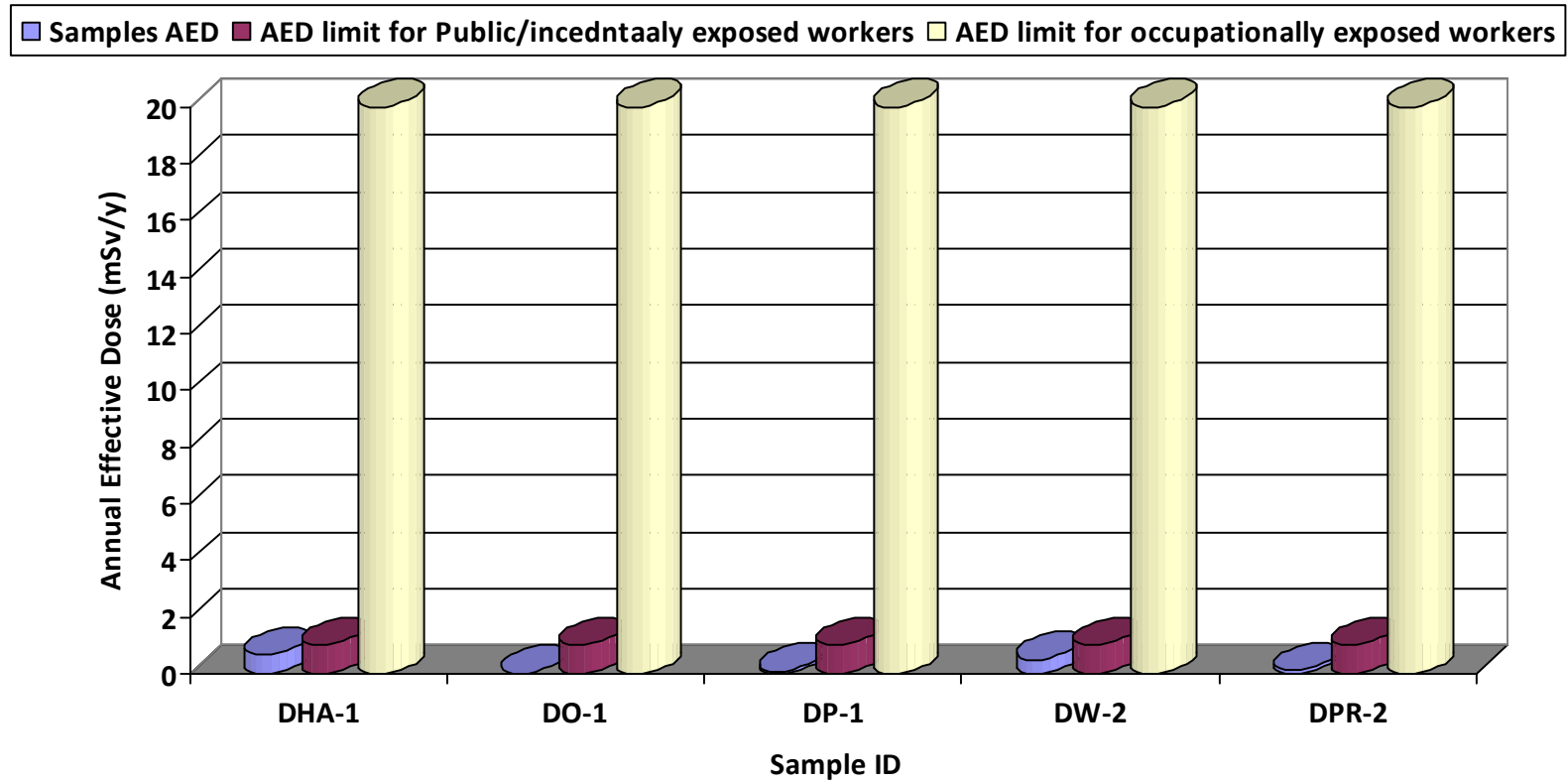

Figure 4.2: Comparison between Annual Effective Dose (AED) result from samples and AED limits for members of the public/Incidentally exposed workers and occupationally exposed workers - (Diffra Field)

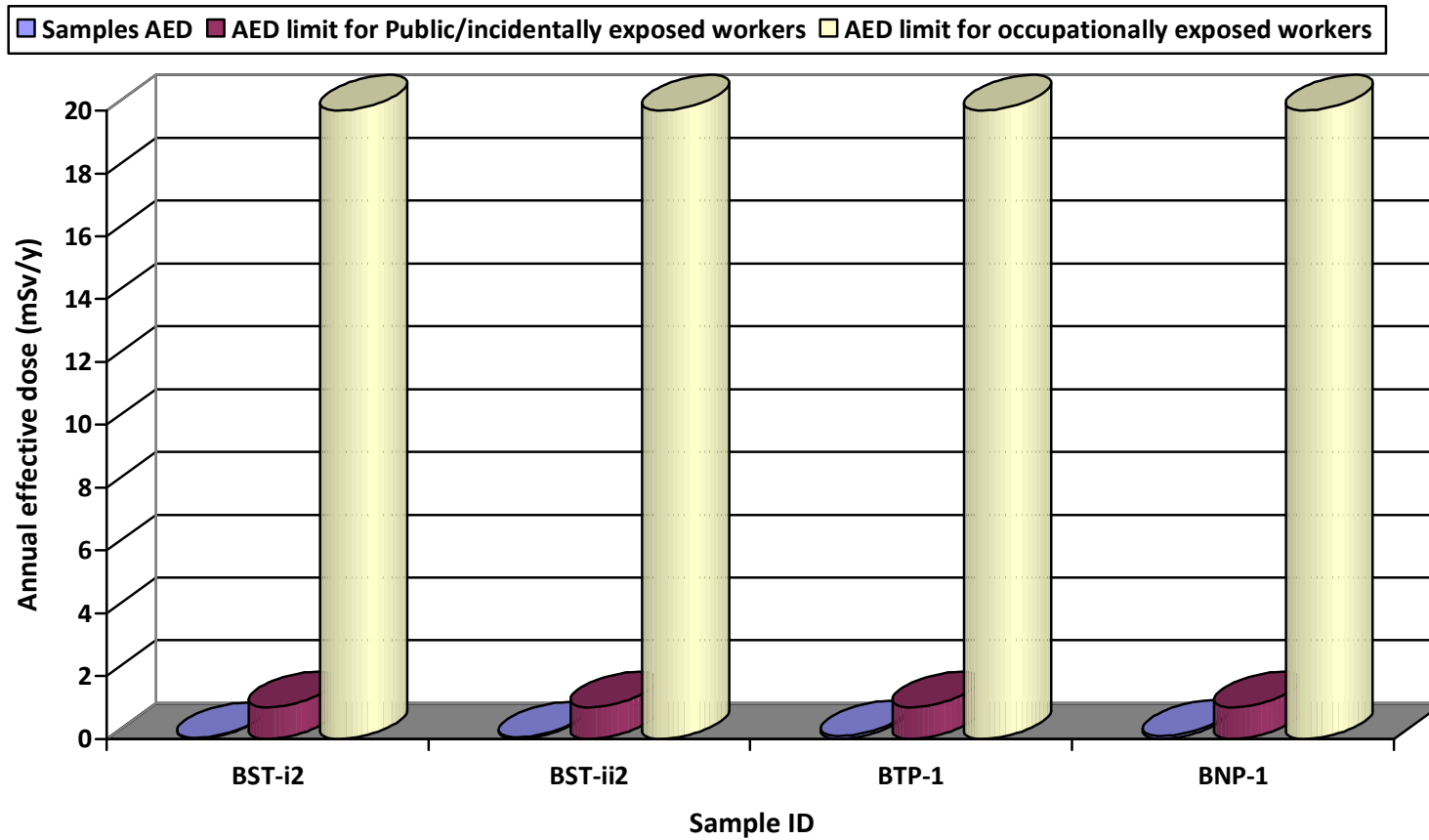

Figure 4.3: Comparison between Annual Effective Dose (AED) result from samples and AED limits for members of the public/Incidentally exposed workers and occupationally exposed workers - (Bamboo Field)

Table 4-4: Heglig Field samples activity concentration, absorbed dose and annual effective dose results:

No.	Sample ID	Concentration of ²³⁸ U (Bq/Kg)	Concentration of ²³² Th (Bq/Kg)	Concentration of ⁴⁰ K (Bq/Kg)	Absorber Dose Rate (nGy/h)	Annual Effective Dose (mSv/y)	Kind of sample
1	HPR-1	23.3	16.19	238.65	30.49	0.03	Sludge
2	HST-1	75.6	77.5	169.6	88.81	0.11	Sludge
3	HG-1	59.13	52.42	224.7	68.35	0.08	Contaminated grass
4	HSD-1	319.41	308.58	145.5	340.02	0.42	Sand
5	HSD-2	186.27	257.32	16.07	242.15	0.3	Sludge
6	H56-2	306.30	436.27	80.35	408.37	0.5	Sand
7	HSTD-2	303.62	32.54	32.14	161.27	0.2	Sludge
8	HFT-2	1961.64	2430.63	45.91	2376.29	2.9	Sand

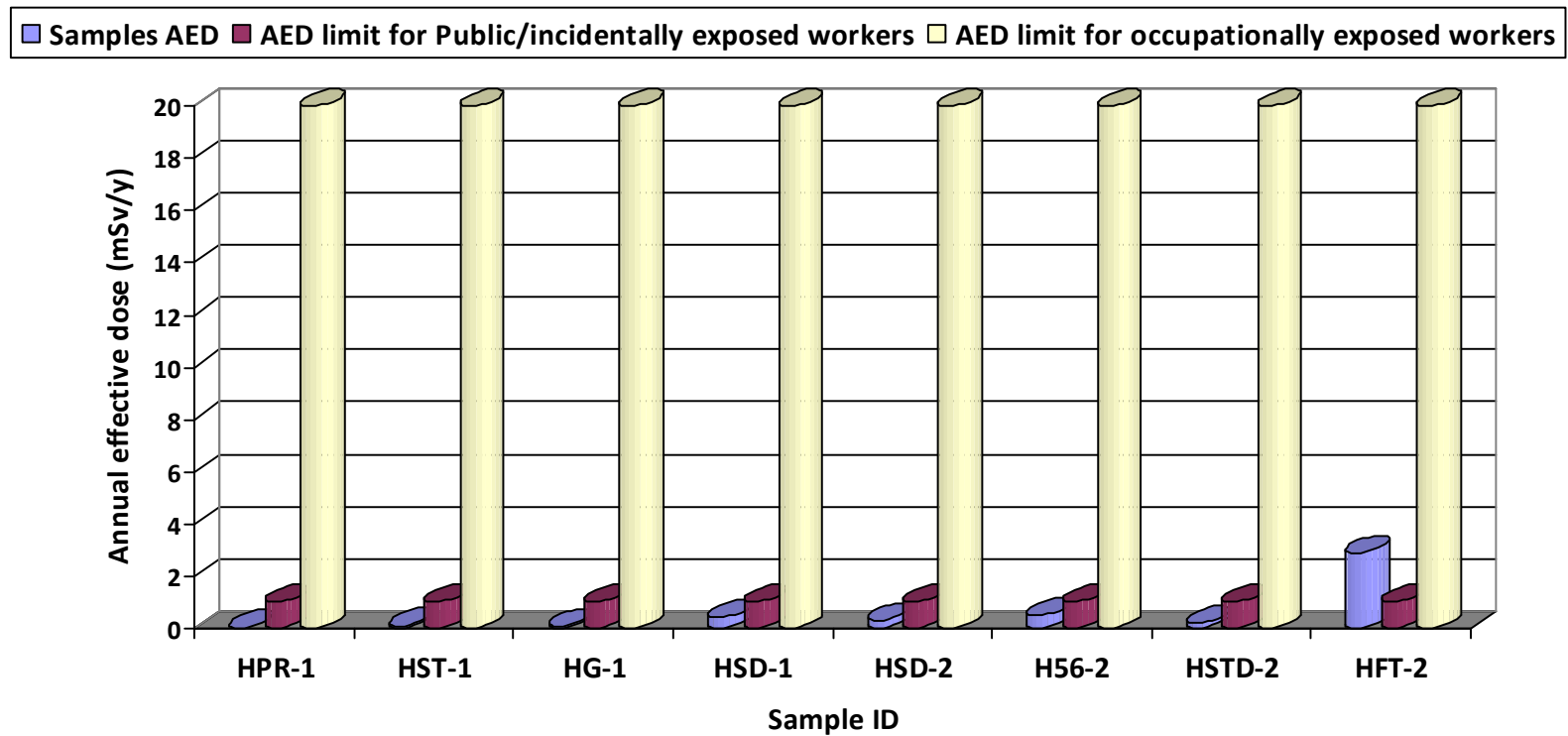

Figure 4.4: Comparison between Annual Effective Dose (AED) result from samples and AED limits for members of the public/Incidentally exposed workers and occupationally exposed worker – (Heglig Field)

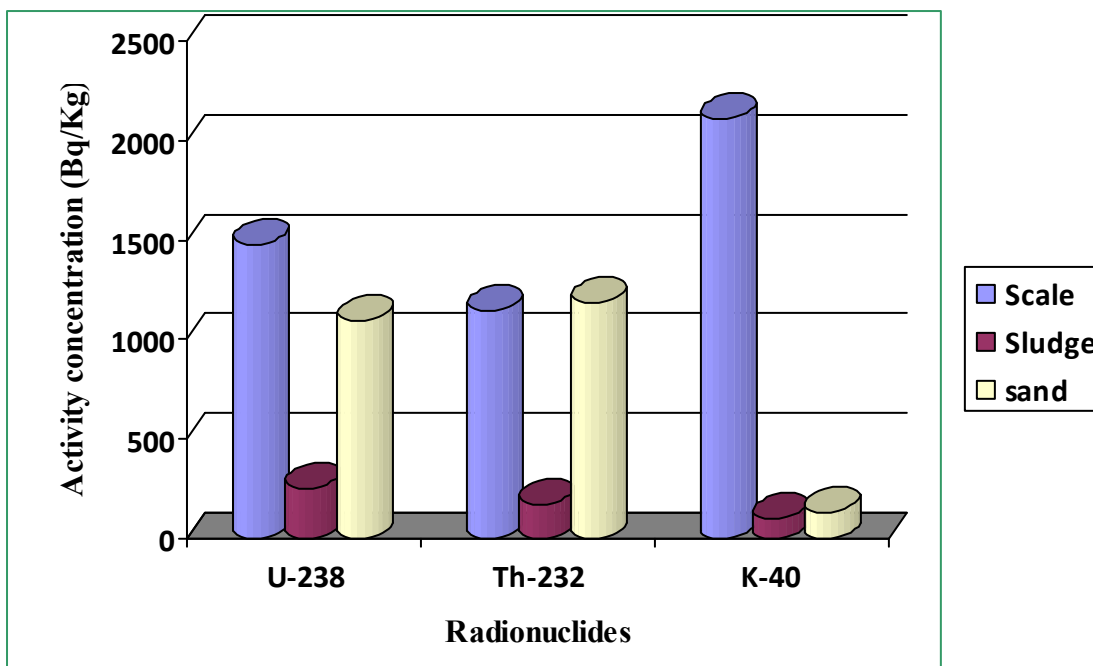

Figure 4.5: Comparison of average activity concentration of radionuclides found in Scale, sludge and sand

4-2 Discussion

The results of samples analysis indicate existence of elevated radionuclides concentration of samples collected from block “4” than samples collected from block “2” (This is due to absence of scale which had high activity concentration from block 2).

The highest concentration was found in scale and sand samples extracted from heaters, vessels and tanks during routine maintenance in different FPFs (highest activity concentration in Heglig field was found in sand extracted from vessel, (it was 2430.63 Bq/Kg and 1961.64 Bq/Kg for ^{238}U & ^{238}Th respectively with absorbed dose rate equal to 2376.29 nGy/h and annual effective dose equal 2.9 mSv/y).

It obvious that all samples annual effective dose are less than 20 mSv/y (which is the limit for occupational workers). But four out of five scale samples and five out of six sand samples from Neem field exceed

1mSv/y (which is the limit for public and incidentally exposed workers. The fifth scale sample had AED equal 0.97 mSv/y and sixth sand sample had AED equal 0.85 mSv/y which is approach to 1 mSv/y. All sludge samples had AED less than 1mSv/y. All other samples from Heglig, Diffra and Bamboo fields have AED less than 1 mSv/y except sand from heglig field which had AED equal to 2.9 mSv/y.

4-3 Conclusions

From previous study of NORM in rocks and soil from Kourdofan state it appear high radionuclide concentration, and since oil and gas industry enhanced levels of NORM due to accumulation of these radionuclides as a result of various industrial activities, so high result in this study is reasonable.

From this study it observed that scale and sand extracted from tanks and vessels are the main contributor of gamma doses in oil field, this is due to that the main types of scale encountered in oil & gas facilities are sulphate scale such as $BaSO_4$, $SrSO_4$ and carbonate scale such as $CaCO_3$. Radium is chemically similar to barium (Ba), strontium (Sr) and calcium (Ca), hence radium co-precipitates with Sr, Ba or Ca scale forming radium sulphate, radium carbonate and – in some cases – radium silicate.

References

- [1] Uliana G. Romanova, Weatherford Laboratories Canada, Calgary, Alberta, Canada
Gennady V. Romanov, A.E. Arbusov Institute of Organic and Physical Chemistry,
Kazan Scientific Centre, Russian Academy of Sciences, Kazan, Tatarstan, Russia –
New horizon (*The Origin of petroleum*)- GeoConvention (2015).
- [2] Ismail S.H Ziada (*Oil in Sudan - Fact and impact on Sudanese
Domestic and International relations*).
- [3] WWW.GNPOC.com.
- [4] IAEA - Proceedings of an international symposium Seville, Spain, (*Naturally
Occurring radioactive material - Norm V*) (19–22 MARCH 2007).
- [5] Radiation Health & Safety Advisory Council for the CEO of ARPANSA
(*Naturally-Occurring Radioactive Material (NORM) in
Australia: Issues for Discussion*) (17 August 2005).
- [6] J. van der Steen and A.W. van Weers (*Radiation protection in NORM
industries*).
- [7] D.G. WYMER-Division of radiation, transport and waste safety-International
Atomic Energy Agency-Vienna, Austria (*Managing exposure to NORM*).
- [8] EPA-United state Environmental Protection Agency – Office of Air and Radiation /
Office of Radiation And in Door Air - EPA-402-K-10-008 (*Radiation: Facts,
Risks and Realities*) (April 2012).
- [9] Jean-Louis Basdevant, James Rich, Michel Spiro (*Fundamentals in
Nuclear Physics*) (April 2005).
- [10] IAEA - Division of Radiation and Waste Safety: A.D. Wrixon; I. Barraclough;
M.J. Clark (Consultant), Division of Public Information: J. Ford (Editor); A. Diesner-
Kuepfer (Design, Illustration and Layout); B. Blann (*RADIATION, PEOPLE
AND THE ENVIRONMENT*) (February 2004).

- [11] UW Environmental Health and Safety (*Principles of Radiation Protection*) (January 2006).
- [12] E.B. Podgorsak - Department of Medical Physics, McGill University Health Centre, Montreal, Quebec, Canada (*Radiation Oncology Physics*) (July 2005).
- [13] James E. Turner (*Atoms, Radiation, and Radiation Protection*) (2007).
- [14] Ken Jenkins, Michael J. Kurtzman (*Modes of Radioactive Decay*) (Jun 2003).
- [15] R.L.HEATH (*Scintillation spectrometry - Gamma ray spectrum catalogue*) (February 1997).
- [16] G. Nelson and D. Reilly (*Gamma-Ray Interactions with Matter*).
- [17] Glenn F.Knoll – University of Michigan (*radiation detection and measurement - third edition*).
- [18] Kristin Erickson (*Introduction to Environmental Engineering - Chapter (14) Ionizing Radiation*).
- [19] Nicholas Tsoulfanidis – University of Missouri (*Measurement and Detection of Radiation*) Second Edition (1995).
- [20] Gordon R. Gilmore – (*Practical Gamma-ray Spectrometry*) Second Edition (2008).
- [21] Ahmed Shawki Habib – PhD thesis - Department of physics – University of Surrey – (*Measurement of NORM in Non-uniform Scale Samples from Libyan Oil Industry Using Gamma Spectroscopy and Monte Carlo Technique*) (November 2012).

- [22] P.Vesterbacka (*²³⁸U-SERIES RADIONUCLIDES IN FINNISH GROUNDWATER-BASED DRINKING WATER AND EFFECTIVE DOSES*) (September 2005).
- [23] Huda Abdulrahman Al-Sulaiti – Ph.D thesis, Department of Physics, University of Surrey (*Determination of Natural Radioactivity Levels in the State of Qatar Using High - Resolution Gamma-ray Spectrometry*) (May 2011).
- [24] IAEA (*Radiation Protection and the Management of Radioactive Waste in the Oil and Gas Industry-IAEA- Training course series 40*) Vienna (2010).
- [25] W.A. Kolb and M. Wojcik (*Enhanced Radioactivity Due to Natural oil and gas production*).
- [26] New York state department of environmental conservation-division of Solid & Hazardous Materials (*An investigation of naturally Occurring Radioactive Material in oil and gas in New York state*) (April 1999).
- [27] International Association of Oil & Gas Producers (**OGP**) Report No 412 (*Guidelines for the management of Naturally Occurring Radioactive Material (NORM) in the oil & gas industry*) (September 2008).
- [28] Jamal Abdul Rahman Zaidan- Petroleum Research & Development Centre -Journal of Petroleum Researches & Studies (*Natural Occurring Radioactive Materials (NORM) in the oil and gas industry*) (2010).
- [29] Australian Petroleum Production & Exploration Association Limited (*Guidelines for naturally occurring radioactive materials*) (March 2002).

- [30] IAEA – Vienna (*Radiation Protection and the Management of Radioactive Waste in the Oil and Gas Industry-IAEA- Safety reports series 34*) (November 2003).
- [31] International Commission on Radiological Protection (ICRP) (*ICRP Publication 65*) (1993).
- [32] Canadian NORM Working Group of the Federal Provincial Territorial Radiation Protection Committee (*Canadian Guidelines for the Management of Naturally Occurring Radioactive Materials (NORM)*) (2011).
- [33] UNSCEAR - United Nations: (*Exposure from natural sources of radiation, in United Nations Scientific Committee on the Effect of Atomic Radiation*) New York (1993).
- [34] Marcel Miglierini-Department of nuclear physics and technology-Slovak university of technology-Bratislava, (*Detection of radiation*) Slovakia (2004).
- [35] Hastings A Smith, Jr., and Marcia Lucas(*Gamma-Ray Detectors*).
- [36] I. Akkurt, K. Gunoglu, and S. S. Arda (*Detection Efficiency of NaI(Tl) Detector in 511-1332 keV Energy Range*) – *Fourth Edition* (March 2014).
- [37] Simon R. Cherry, James A. Sorenson, Michael E. Phelps (*Physics in Nuclear Medicine*) (2012).
- [38] I. Hossain, N. Sharip and K. K. Viswanathan2 (*Efficiency and resolution of HPGe and NaI(Tl) detectors using gamma-ray spectroscopy*) (December 2011).
- [39] Ian Rittersdorf (*Gamma Ray Spectroscopy*) (March 2007).
- [40] A.S Pashoa – Private Consultant, Rio de Janeiro, Brazil – F. Steinhausler – University of Salzburg, Division of Physics and Biophysics, Salzburg, Austria (*Technological Enhanced Natural Radiation*).

APPENDICES

Appendix I

Sample points Locations



Figure I-1: CPF Sample points - Heglig



Figure I-2: Heglig -56 Sample points - Heglig



Figure I-3: Neem FPF Sample points - Neem



Figure I-4: Neem - 03 Sample points - Neem

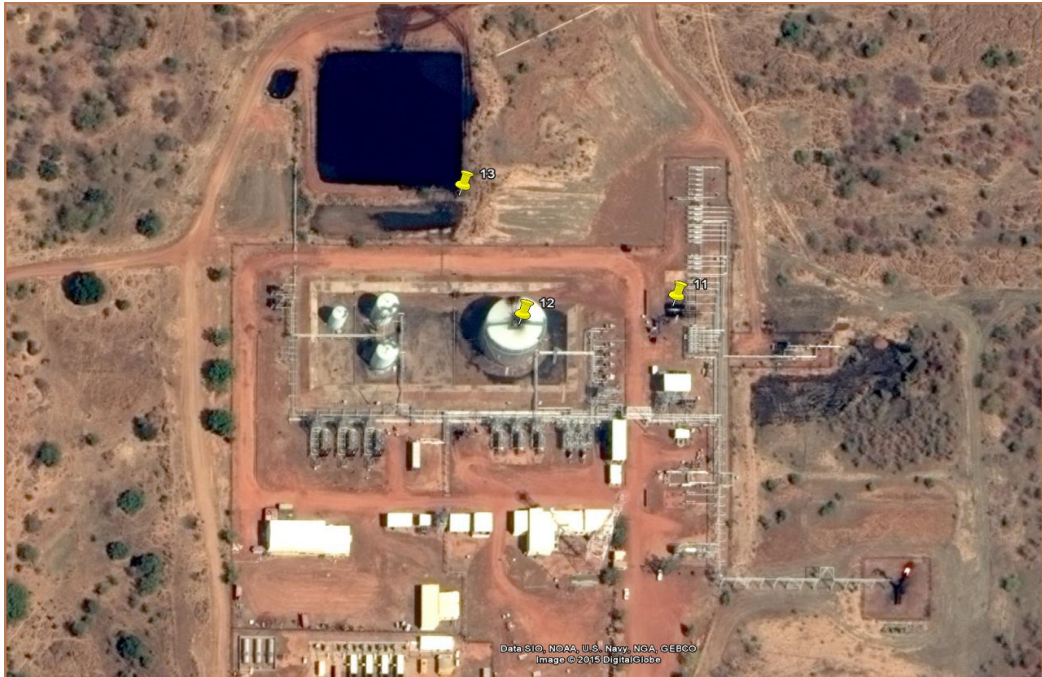

Figure I-5: Diffra FPF Sample points - Diffra



Figure I-6: WE-01 Sample points - Diffra



Figure I-7: HA-01 Sample points - Diffra



Figure I-8: Bamboo FPF Sample points

Appendix II

Sample Points Coordinates

No.	Name	Latitude	Longitude
1	Storage tank (Heglig-CPF)	10.006394°	29.398653°
2	Diffra big receiver (Heglig-CPF)	10.007103°	29.396217°
3	FWKO - (Heglig-CPF)	10.005635°	29.396613°
4	Pond - (Heglig-CPF)	10.007611°	29.401187°
5	Flare - (Heglig-CPF)	10.007457°	29.395000°
6	Heglig-56 – Heglig well site	9.985607°	29.409788°
7	Heater treater – Neem FPF	10.925315°	28.565365°
8	FWKO - Neem FPF	10.924387°	28.565424°
9	PWT - Neem FPF	10.925357°	28.565997°
10	CPI - Neem FPF	10.925567°	28.565918°
11	Neem Big receiver- Diffra FPF	10.039350°	28.411945°
12	Tank - Diffra FPF	10.039267°	28.411316°
13	Pond - Diffra FPF	10.039843°	28.411073°
14	Diffra WE-1 – Diffra well site	10.043009°	28.402954°
15	Sand trap – Bamboo FPF	10.271892°	29.373642°
16	Pond – Bamboo FPF	10.272057°	29.372907°
17	HA-1 – Diffra well site	10.031093°	28.388181°
18	Neem - 03	10.902467°	28.570662°

Appendix III

Kind of samples

No.	Sample Points	Kind of Sample
1	Storage tank (Heglig-CPF)	Sludge
2	Diffra big receiver (Heglig-CPF)	Sludge
3	FWKO - (Heglig-CPF)	Sand
4	Pond - (Heglig-CPF)	Sand
5	Flare - (Heglig-CPF)	Contaminated grass
6	Heglig-56 – Heglig well site	Sand
7	Heater treater – Neem FPF	Scale, Sand & Sludge
8	FWKO - Neem FPF	Scale, Sand & Sludge
9	PWT - Neem FPF	Scale, Sand & Sludge
10	CPI - Neem FPF	Sludge
11	Neem Big receiver- Diffra FPF	Sludge
12	Tank - Diffra FPF	Crude Oil
13	Pond - Diffra FPF	Sludge
14	Diffra WE-1 – Diffra well site	Scale
15	Sand trap – Bamboo FPF	Sand
16	Pond – Bamboo FPF	Sand
17	HA-1 – Diffra well site	Scale
18	Neem - 03	Scale

Appendix IV

Some sample sources

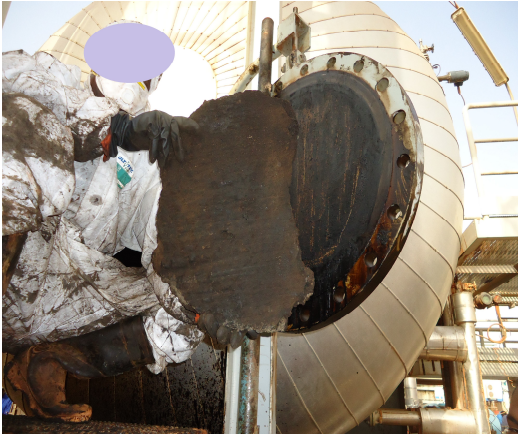

A bulk of scale extracted during Routine maintenance



Abandoned pipeline due to heavy scale formation



Sludge inside heater treater



Sand extracted from vessel and put in drums in special closed area